

**awv**  
architectural

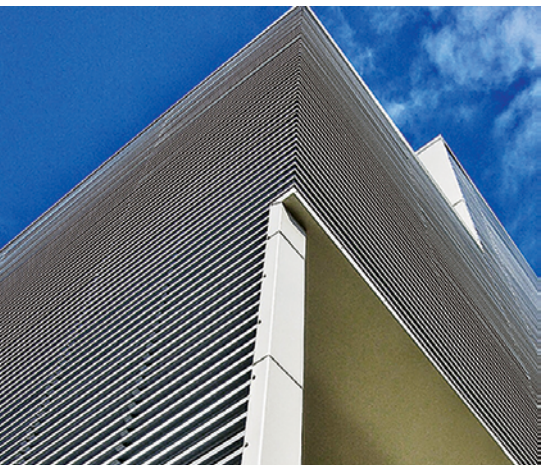

## Architectural Products

Louvers  
Grilles & Vision Screens  
Sunshades  
Penthouses







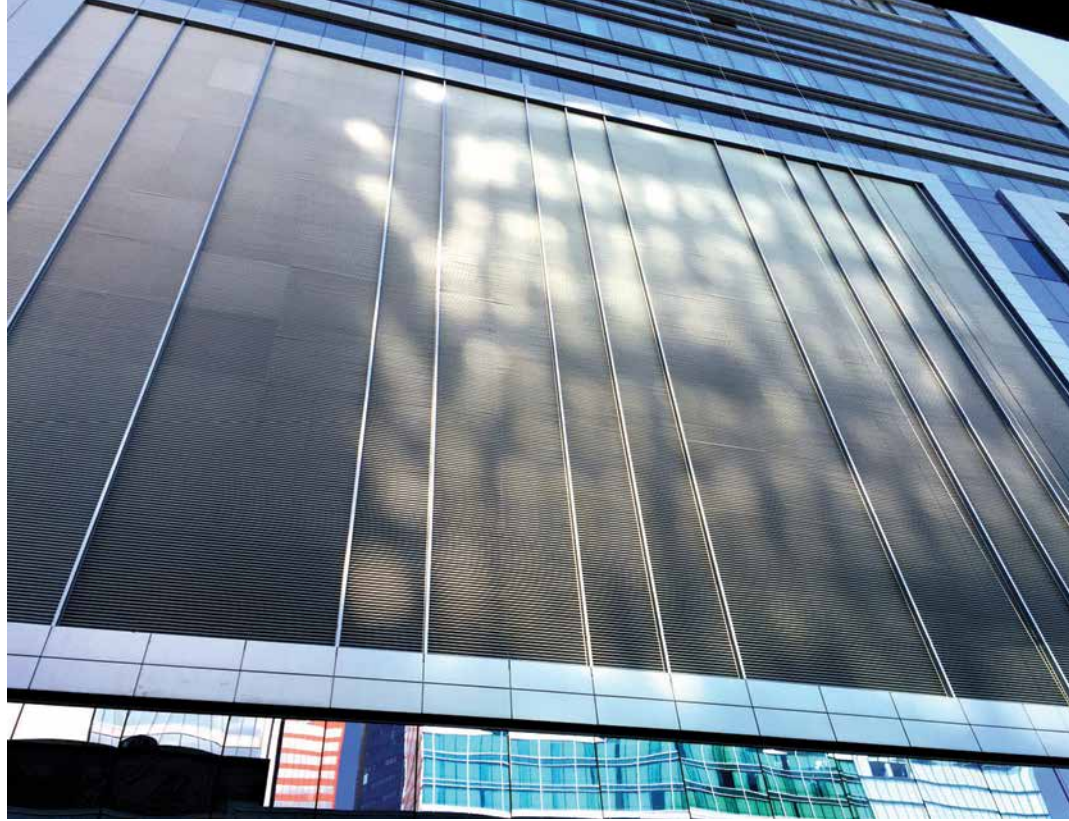





About Us .....	6
Louvers .....	8
Louver Options .....	10
Fixed Drainable Louvers .....	12
Fixed Non-Drainable Louvers .....	13
Adjustable Louvers .....	14
Combination Louvers .....	15
Thin Line Louvers .....	16
Acoustical Louvers .....	17
Wind Driven Rain Louvers .....	18
Hurricane Louvers .....	20
FEMA Louvers .....	21
Grilles / Vision Screens .....	22
Grille / Screen Options .....	22
Architectural Grilles .....	26
Architectural Vision Screens .....	28
Sunshades .....	30
Sunshade Options .....	30
Blade Styles .....	34
Grille, Perforated Panels, & Façade Styles .....	35
Outrigger & Downrigger Styles .....	36
Mounting Methods .....	37
Penthouses .....	38
Penthouse Options .....	38
Fixed Drainable Penthouses .....	42
Fixed Non-Drainable Penthouses .....	43



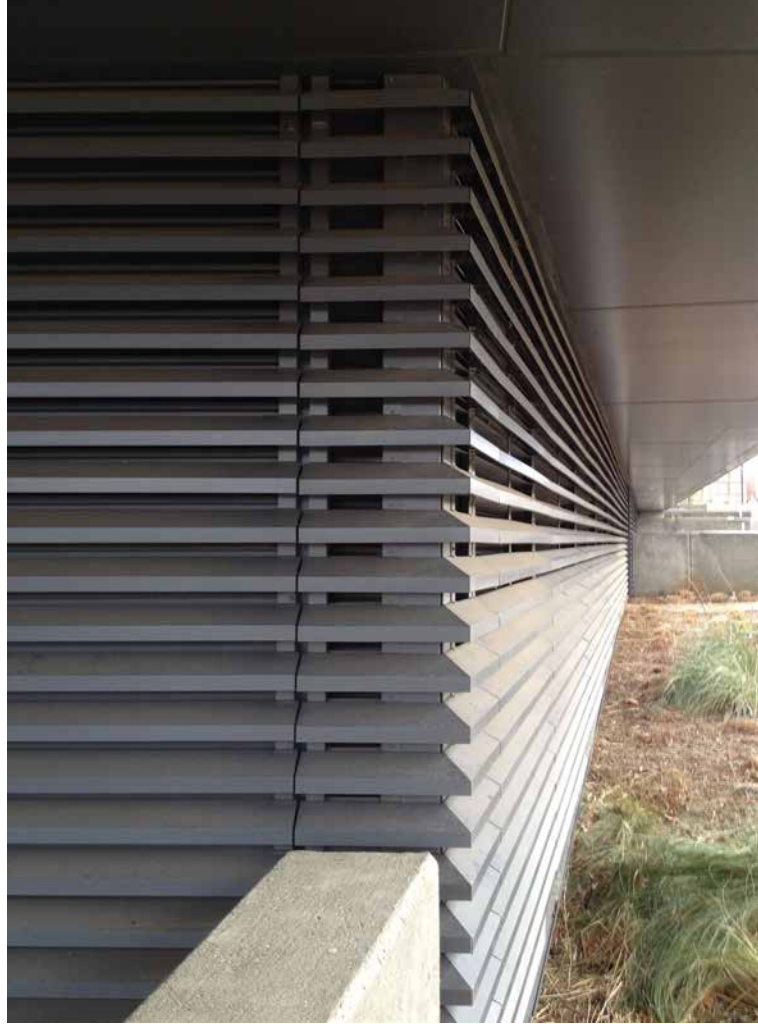



# AWV architectural

AWV is headquartered in Holland, Ohio and is a division of Messtek, Inc. Our emphasis is to provide architectural products and solutions to enhance the beauty and performance of today's building designs.

AWV has more than 100 years of unsurpassed experience in the design and supply of architectural products. Our portfolio, with tens of thousands of successful projects, includes some of the largest, most complex projects in both new and renovation applications.



First office in Toledo, Ohio.

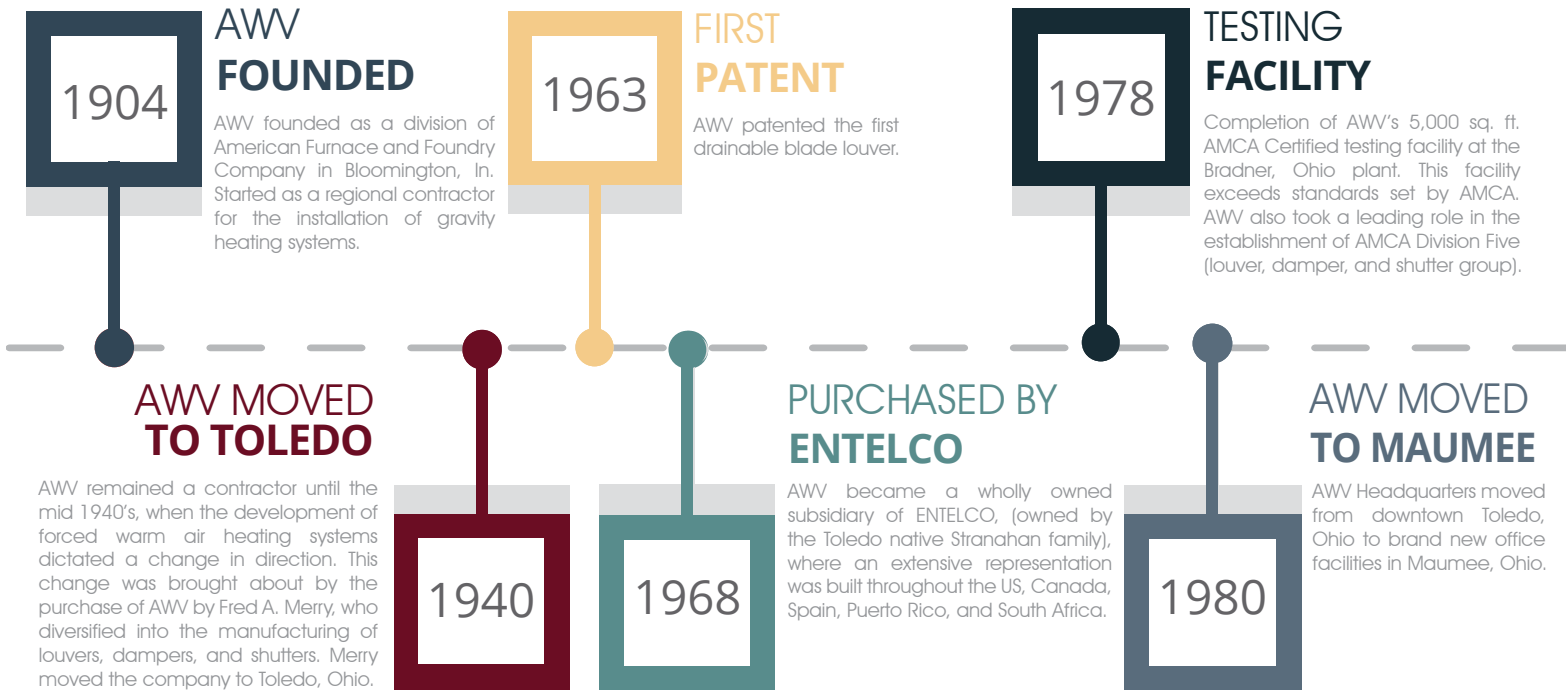

Manufacturing facility in Bradner, Ohio.





Architects, mechanical engineers, contractors, and facility owners rely on American Warming and Ventilating to meet their ever-changing damper and louver designs and cost requirements through product innovation and technological advancement.

The Product Development and Testing Laboratory is proof of AWV's pursuit of product excellence. Here, new product concepts and refinements to existing designs undergo rigorous testing before being introduced to the marketplace.

Designed and built in 1977 to test dampers to the exacting requirements of the nuclear power industry, the laboratory has one of the largest flow and pressure capabilities of any facility in the damper, shutter and louver industries.

Tests are performed following the AMCA Standard 500 Test Procedure, which is highly regarded by customers and contract users alike. AMCA audits the calibration of equipment, performance testing of products, and the laboratory itself every three years. Test results are audited each time a contract test is performed and witnessed. Contract customers receive all necessary documentation of the test results.



On-site AMCA certified testing lab Bradner, Ohio.

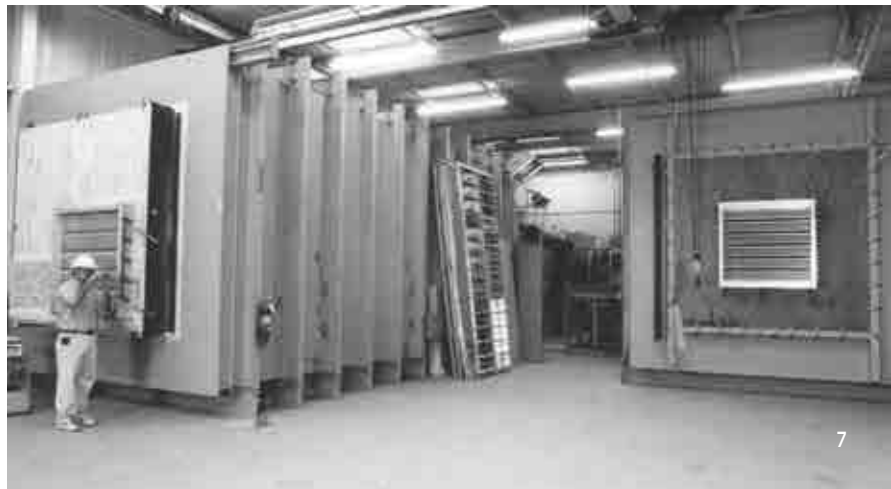





# Louvers





Children's Hospital of Pittsburgh

The purpose of louvers is to provide ventilation or exhaust air, while offering defense against vision, water and noise intrusion. In addition, the louver designs must give the architect aesthetic flexibility to enhance the building's appearance. AWV's broad line of architectural louvers address these design objectives.

## AWV'S OFFERING



### Aesthetically Pleasing

AWV architectural louvers are designed with aesthetics in mind.



### Reduced Energy Costs

AWV's louvers are highly aerodynamically efficient. The low air resistance reduces the fan energy required to introduce the ventilation air into or exhaust air out of the building.



### Wide Range

AWV louvers are available in a wide variety of shapes, sizes, materials, finishes and coatings to meet the requirements of any project.



### Durability

AWV can provide certified structural calculations when requested to ensure louver structural integrity. All architectural louvers are constructed of aluminum.



### Enhanced and Proven Performance

AWV louvers are both efficient and have a remarkably high resistance to water intrusion. Our louvers have been completely tested for air performance and water penetration.



AWV is a member of the Air Movement and Control Association (AMCA) and our product performance is AMCA certified.



# Louvers

## STANDARD FINISHES

AWV architectural louvers can be provided in mill, anodized, baked enamel, PVDF (aka Kynar) and other special finishes. AWV is a licensed applicator for Akzo Nobel, PPG and Valspar to meet AAMA painting (2603, 2604 & 2605) specifications.

Clear anodizing provides a uniform satin finish that resists oxidation. The 204R1 clear provides a 0.4 mil coating, while the 215R1 clear provides a 0.7 mil coating for extra corrosion and abrasion resistance. Color anodizing is also available in light, medium, dark bronze or black in a 0.7 mil coating.

PVDF (aka Kynar) is a baked-on finish made of 70% PVDF resins and durable ceramic pigments that meets AAMA2605 specifications. PVDF is unsurpassed in its resistance to color fading and chalking from the damaging ultraviolet rays of the sun. It is resistant to general air pollution and will not whiten or pit when exposed to the elements.

PVDF finishes are available in a wide range of colors and glosses. Metallic, pearlescent, and other more exotic formulations are also available. Refer to AWV's Standard Finishes Color Selection brochure for our standard choice of colors. Special color matching can be provided by our in-house computerized paint color formulating system.

## CUSTOM SHAPES

AWV offers louvers in any style and shape, not just square or rectangular. Full, half and quarter rounds, triangular and other shapes are available. Just send us a sketch of the shape and dimensions required and we'll engineer a solution.

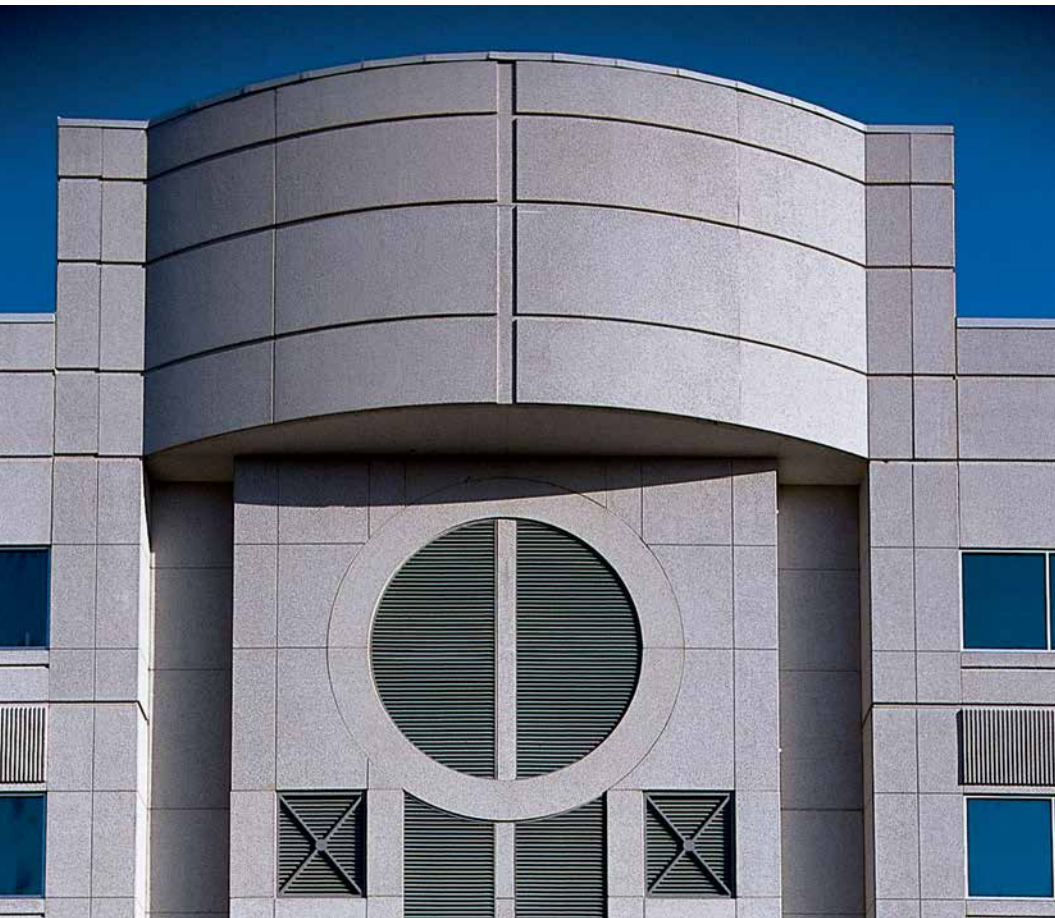

## CUSTOM FINISHES

While architectural louvers are typically constructed of extruded aluminum, special appearances can be provided through a dye-sublimation process to turn ordinary materials into a work of art. We transform the aluminum to look identical to wood grain, marble, granite, masonry, carbon fiber and any creative digital design to give your project a unique signature appearance.





## OPTIONS AND ACCESSORIES

AWV offers a wide selection of options and accessories to simplify installation and provide the functionality required.

- Exposed or hidden mullions
- Variable blade spacing and angles
- Electric, pneumatic and manual actuators, various actuator bracket mountings, linkage materials and bearings for adjustable louvers
- Welded and non-welded construction in varying material thicknesses
- Insect/bird screens and hinged access doors
- Sill extensions and blank-off panels of varying dimensions
- Mounting angles, glazing tabs and flanged frames

## LEAD TIMES/QUICK DELIVERY

AWV offers competitive and short lead times. In addition, quick ship programs are available on selected models for extra fast delivery.

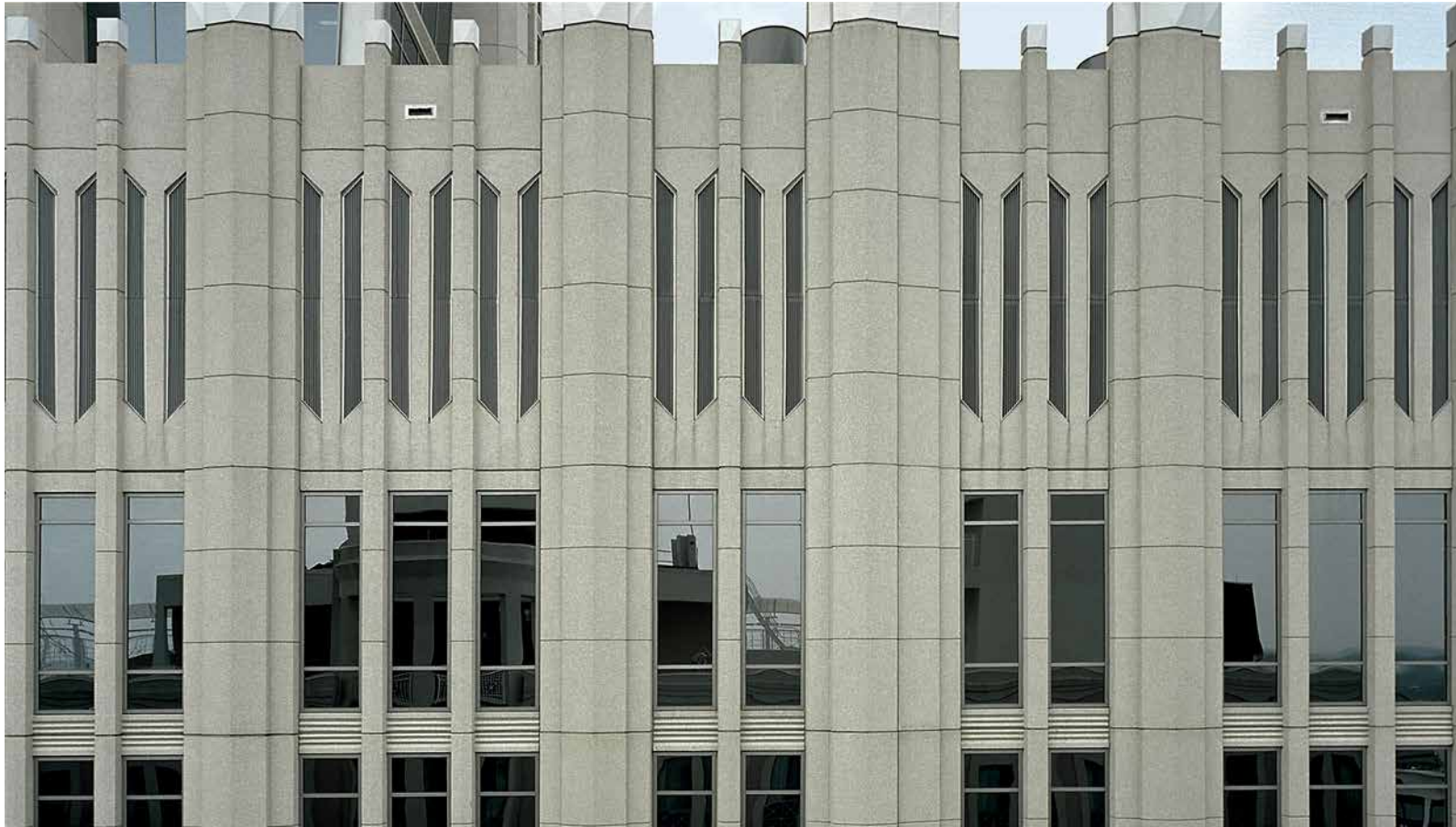



# Fixed Drainable Louvers



Moses Cone Hospital North Tower - LE-23



Fixed drainable extruded aluminum architectural louvers are offered in a variety of frame depths, blade angles and spacing. They provide excellent air and water resistance performance and are appropriate for both intake and exhaust applications.

Model	Description	Blade			Frame Depth Inches	Free Area		Water Penetration Rating (WPR) Feet/minute	Pressure Drop @ WPR inches W.C.	Air Flow SCFM	Material Thickness (Frame/Blade) Inches	Certification Rating			Single Panel Size	
		Orientation H - Horiz. V - Vert.	Angle Deg.	Spacing Inches		Sq. Ft.	%					AMCA	Miami Dade	Sight Proof	Min W x H Inches	Max W x H Inches
LE-21	Fixed Drainable	H	45.0	5.00	4.00	8.01	50	1025	0.20	8210	0.081 / 0.081	Y	-	-	12 x 12	96 x 96
LE-22	Fixed Drainable	H	45.0	5.00	4.00	8.37	52	1075	0.15	8998	0.125 / 0.125	Y	Y	-	12 x 12	60 x 96
LE-23	Fixed Drainable	H	37.5	3.50	4.00	8.90	56	1009	0.13	8980	0.081 / 0.081	Y	-	-	12 x 12	96 x 96
LE-24	Fixed Double Drainable	H	40.0	4.00	4.00	8.11	51	1026	0.16	8321	0.081 / 0.081	Y	-	-	12 x 12	96 x 96
LE-31	Fixed Drainable	H	37.5	4.00	6.00	9.24	58	1193	0.20	11023	0.081 / 0.081	Y	-	-	12 x 12	96 x 96
LE-32	Fixed Drainable	H	37.5	4.00	6.00	9.24	58	1193	0.20	11023	0.125 / 0.081	Y	Y	-	12 x 12	96 x 96
LE-33	Fixed Double Drainable	H	45.0	7.00	6.00	8.00	50	1033	0.19	8264	0.081 / 0.081	Y	-	-	12 x 12	96 x 96
LE-34	Fixed Double Drainable	H	45.0	6.00	6.00	7.71	48	1212	0.24	9345	0.081 / 0.081	Y	-	-	12 x 12	96 x 96
LE-52	Fixed Chevron Sight Proof Drainable	H	19.0	2.00	5.00	8.52	53	1098	0.33	9355	0.081 / 0.081	Y	-	Y	12 x 12	96 x 96

**Notes:**

AMCA certified performance based on 4' x 4' louver

Standard construction designed for 25 PSF (100 mph) wind load for maximum single panel size



# Fixed Non-Drainable Louvers



The Guest House at Graceland - LE-27

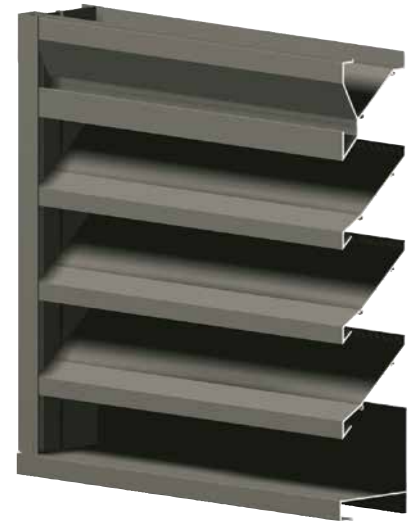

Fixed non-drainable extruded aluminum architectural louvers are offered in a variety of frame depths, blade angles and spacing. Either horizontal or vertical blades are available. They are usually most appropriate for exhaust applications.

Model	Description	Blade			Frame Depth Inches	Free Area		Water Penetration Rating (WPR) Feet/minute	Pressure Drop @ WPR inches W.C.	Air Flow SCFM	Material Thickness (Frame/Blade) Inches	Certification Rating			Single Panel Size	
		Orientation H - Horiz. V - Vert.	Angle Deg.	Spacing Inches		Sq. Ft.	%					AMCA	Miami Dade	Sight Proof	Min W x H Inches	Max W x H Inches
LE-27	Fixed Non-drainable	H	45.0	4.00	4.00	9.03	56	779	0.09	7034	0.081 / 0.081	Y	-	-	12 x 12	96 x 96
LE-47	Fixed Non-drainable	H	45.0	5.00	4.00	8.21	51	822	0.18	6749	0.081 / 0.081	Y	-	-	12 x 12	96 x 96
LE-48	Fixed Non-drainable	H	45.0	5.00	4.00	8.21	51	822	0.18	6749	0.081 / 0.081	Y	-	-	12 x 12	96 x 96
LE-49	Fixed Non-drainable	H	30.0	3.50	4.00	9.17	57	902	0.11	8271	0.081 / 0.081	Y	-	-	12 x 12	96 x 96
LE-63	Fixed Non-drainable	H	45.0	7.00	6.00	7.92	50	1076	0.20	8522	0.081 / 0.081	Y	-	-	12 x 12	96 x 96
LE-81V	Fixed Inverted Y Sight Proof Non-drainable	V	45.0	4.00	4.00	4.78	30	-	0.28	3346	0.081 / 0.081	Y	-	Y	12 x 12	96 x 96
LE-81H	Fixed Inverted Y Sight Proof Non-drainable	H	45.0	4.00	4.00	4.57	29	691	0.25	3158	0.081 / 0.081	Y	-	Y	12 x 12	96 x 96
BV-10	Brick Vent Non-drainable	H	45	-	4.00	-	-	-	-	-	0.125 / 0.125	-	-	-	8 x 2½	24 x 7¼

**Notes:**

AMCA certified performance based on 4' x 4' louver

Standard construction designed for 25 PSF (100 mph) wind load for maximum single panel size



# Adjustable Louvers



Adjustable extruded aluminum architectural louvers are offered in a variety of frame depths, blade angles and spacing. Both drainable and non-drainable models are available. They provide the ability to modulate the blade angles. Actuator options include manual, electric and pneumatic.



Close-King Indoor Practice Facility - LE-33A

Model	Description	Blade			Frame Depth Inches	Free Area		Water Penetration Rating (WPR) Feet/minute	Pressure Drop @ WPR inches W.C.	Air Flow SCFM	Material Thickness (Frame/Blade) Inches	Single Panel Size	
		Orientation H - Horiz. V - Vert.	Angle Deg.	Spacing Inches		Sq. Ft.	%					Min W x H Inches	Max W x H Inches
LE-21A	Adjustable Drainable	H	45.0	5.00	4.00	7.51	47	923	0.17	6932	0.081 / 0.081	12 x 12	60 x 96
LE-31A	Adjustable Drainable	H	37.5	4.00	6.00	9.49	59	1073	0.22	10182	0.081 / 0.081	12 x 12	48 x 96
LE-33A	Adjustable Drainable	H	45.0	7.00	6.00	7.86	49	929	0.20	7307	0.081 / 0.081	12 x 12	60 x 96
LE-47A	Adjustable Non-drainable	H	45.0	5.00	4.00	7.61	48	740	0.19	5631	0.081 / 0.081	12 x 12	60 x 96
LE-48A	Adjustable Non-drainable	H	45.0	5.00	4.00	7.61	48	740	0.19	5631	0.081 / 0.081	12 x 12	60 x 96
LE-63A	Adjustable Non-drainable	H	45.0	7.00	6.00	7.80	49	968	0.22	7553	0.081 / 0.081	12 x 12	60 x 96
LE-88A	Adjustable Non-drainable	H	70.0	5.00	6.00	10.41	65	739	0.19	7693	0.081 / 0.081	12 x 12	60 x 96

**Notes:**

Performance based on 4' x 4' louver

Standard construction designed for 25 PSF (100 mph) wind load for maximum single panel size



# Combination Louvers

Combination extruded aluminum architectural louvers are offered in a variety of frame depths, blade angles and spacing. All combination models are drainable. Combination louvers offer stationary front blades with hidden adjustable rear blades. This provides adjustability while still giving the fixed sight lines on the visible exterior of the building.

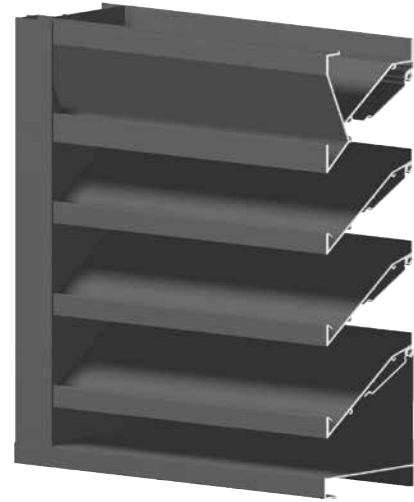

Model	Description	Blade			Frame Depth Inches	Free Area		Water Penetration Rating (WPR) Feet/minute	Pressure Drop @ WPR inches W.C.	Air Flow SCFM	Material Thickness (Frame/Blade) Inches	Certification Rating			Single Panel Size	
		Orientation H - Horiz. V - Vert.	Angle Deg.	Spacing Inches		Sq. Ft.	%					AMCA	Miami Dade	Sight Proof	Min W x H Inches	Max W x H Inches
LE-32C	Combination Drainable	H	37.5	4.00	6.00	8.19	51	1250	0.15	10240	0.125 / 0.081	Y	Y	-	12 x 12	60 x 96
LE-45C	Combination Drainable	H	40.0	4.00	4.00	6.78	42	1250	0.17	8475	0.081 / 0.081	Y	-	-	12 x 12	60 x 96
LE-64B	Combination Drainable	H	30.0	5.00	6.00	7.04	44	1039*	0.12	7315	0.081 / 0.081	-	-	-	12 x 12	96 x 96
LE-65C	Combination Drainable	H	37.5	4.00	6.00	8.19	51	1250	0.15	10240	0.081 / 0.081	Y	-	-	12 x 12	60 x 96
LE-66C	Combination Drainable	H	45.0	6.19	6.00	6.46	40	1250	0.20	8075	0.081 / 0.081	Y	-	-	12 x 16	48 x 96

**Notes:**

AMCA certified performance based on 4' x 4' louver

Standard construction designed for 25 PSF (100 mph) wind load for maximum single panel size

\* Pressure drop velocity only



# Thin Line Louvers



Thin line extruded aluminum architectural louvers are offered in a variety of frame depths, blade angles and spacing. Both drainable and non-drainable models are available. They are intended for use in applications where a limited louver frame depth is required. They easily integrate with most curtain wall and window framing systems.



Model	Description	Blade			Frame	Free Area		Water Penetration Rating (WPR) Feet/minute	Pressure Drop @ WPR inches W.C.	Air Flow SCFM	Material Thickness (Frame/Blade) Inches	Certification Rating			Single Panel Size	
		Orientation H - Horiz. V - Vert.	Angle Deg.	Spacing Inches	Depth Inches	Sq. Ft.	%					AMCA	Miami Dade	Sight Proof	Min W x H Inches	Max W x H Inches
LE-15	Thin Line Fixed Non-drainable	H	45	2.00	1.50	7.540	47	519	0.05	3913	0.063 / 0.063	Y	-	-	12 x 12	96 x 96
LE-57	Thin Line Fixed Non-drainable	H	45	3.00	2.00	7.200	45	523	0.06	3766	0.063 / 0.063	Y	-	-	12 x 12	96 x 96
LE-58	Thin Line Fixed Drainable	H	45	2.50	2.00	7.770	49	872	0.15	6775	0.063 / 0.063	Y	-	-	12 x 12	96 x 96

**Notes:**

AMCA certified performance based on 4' x 4' louver

Standard construction designed for 25 PSF (100 mph) wind load for maximum single panel size



# Acoustical Louvers

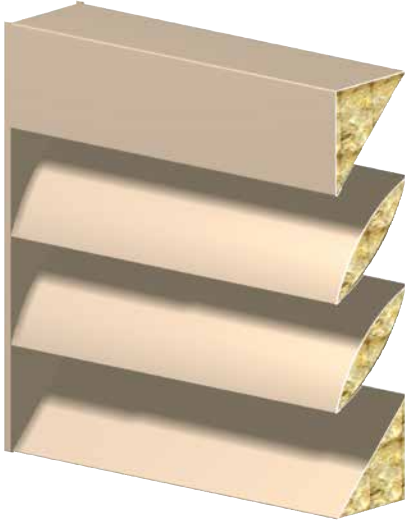

Acoustical fabricated aluminum architectural louvers are offered in a variety of frame depths, blade angles and spacing. All acoustical models are non-drainable. The airfoil blades are filled with fire and water resistant, sound absorbing insulation.



## Sound Attenuation Ratings

Model	Octave Band	1	2	3	4	5	6	7	8
	Frequency (Hz)	63	125	250	500	1000	2000	4000	8000
LAA-66	Transmission Loss (dB)	1	6	6	9	13	15	14	14
	Free Field Noise Reduction (dB)	7	12	12	15	19	21	20	20
LAA-86	Transmission Loss (dB)	1	4	5	9	16	19	16	13
	Free Field Noise Reduction (dB)	7	10	11	15	22	25	22	19
LAA-88	Transmission Loss (dB)	1	5	6	9	13	16	13	11
	Free Field Noise Reduction (dB)	7	11	12	15	19	22	19	17
LAA-129	Transmission Loss (dB)	2	8	12	16	23	28	25	17
	Free Field Noise Reduction (dB)	8	14	18	22	29	34	31	23
LAA-1212	Transmission Loss (dB)	9	7	8	13	19	14	11	9
	Free Field Noise Reduction (dB)	15	13	14	19	25	20	17	15
LAA-1215	Transmission Loss (dB)	2	6	6	9	12	11	9	11
	Free Field Noise Reduction (dB)	8	12	12	15	18	17	15	17
LAA-12AF	Transmission Loss (dB)	7	6	7	13	15	13	10	9
	Free Field Noise Reduction (dB)	14	12	14	19	21	19	16	15

Model	Description	Blade			Frame	Free Area		Water Penetration Rating (WPR) Feet/minute	Pressure Drop @ WPR inches W.C.	Air Flow SCFM	Material Thickness (Frame/Blade/Perf) Inches	Certification Rating		Single Panel Size	
		Orientation H - Horiz. V - Vert.	Angle Deg.	Spacing Inches	Depth Inches	Sq. Ft.	%					AMCA	STC Class	Min W x H Inches	Max W x H Inches
LAA-66	Fixed Non-drainable	H	45.0	6.00	6.00	4.23	26	858	0.08	3629	0.080 / 0.061 / 0.032	Y	12	12 x 15	72 x 96
LAA-86	Fixed Non-drainable	H	45.0	6.00	8.00	4.24	27	990*	0.10	4198	0.080 / 0.061 / 0.032	-	14	12 x 17	72 x 96
LAA-88	Fixed Non-drainable	H	45.0	8.00	8.00	4.01	25	956	0.09	3834	0.080 / 0.061 / 0.032	Y	12	12 x 20	72 x 96
LAA-129	Fixed Non-drainable	H	45.0	9.00	12.00	2.38	15	990*	0.10	2356	0.080 / 0.061 / 0.032	-	21	12 x 24	72 x 96
LAA-1212	Fixed Non-drainable	H	45.0	12.00	12.00	3.46	22	1089	0.10	3931	0.080 / 0.061 / 0.032	Y	14	12 x 30	72 x 96
LAA-1215	Fixed Non-drainable	H	45.0	15.00	12.00	5.53	35	1173*	0.13	6487	0.080 / 0.061 / 0.032	-	10	12 x 36	72 x 96
LAA-12AF	Fixed Non-drainable	H	45.0	12.00	12.00	3.49	22	1127	0.06	4001	0.080 / 0.061 / 0.032	Y	13	12 x 24	72 x 96

**Notes:**

AMCA certified performance based on 4' x 4' louver

Standard construction designed for 25 PSF (100 mph) wind load for maximum single panel size

\*Pressure drop velocity only



# Wind-Driven Rain Louvers

Wind-driven rain architectural louvers are offered in a variety of frame depths, blade angles and spacing. All wind-driven rain louvers are drainable and provide the highest AMCA class A rating against the damaging effects of rain penetration. Either horizontal or vertical blades are available.

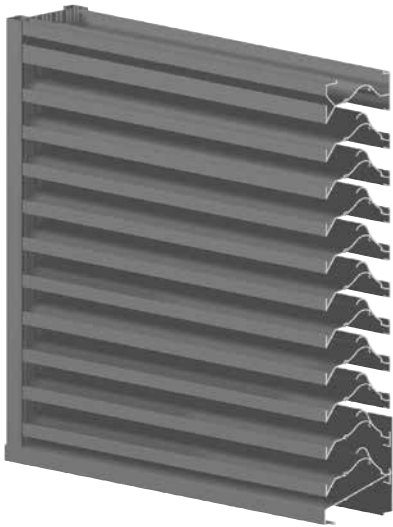

Duke Energy Center - LE-59

Model	Description	Blade		Frame	Free Area		Water Penetration Rating (WPR) Feet/minute	Pressure Drop @ WPR inches W.C.	Air Flow SCFM	Core Velocity Feet/minute
		Orientation H - Horiz. V - Vert.	Spacing Inches	Depth Inches	Sq. Ft.	%				
LE-29	Wind Driven Rain Fixed Drainable	V	0.69	2.00	6.28	39	1250	0.32	7850	777
LE-42	Wind Driven Rain Fixed Drainable	V	1.63	4.00	4.40	41	-	-	-	688
LE-44	Wind Driven Rain Fixed Drainable	H	1.63	4.00	8.01	50	1250	0.55	10013	284
LE-53	Wind Driven Rain Fixed Drainable	H	2.00	5.00	7.08	44	1250	0.31	8850	583
LE-54	Wind Driven Rain Fixed Drainable	H	2.00	5.00	7.08	44	1250	0.31	8850	583
LE-59	Wind Driven Rain Fixed Drainable	H	2.00	5.00	8.19	51	1250	0.31	10238	582
LE-62	Wind Driven Rain Fixed Drainable	H	2.50	6.00	3.16	20	-	-	-	685
LE-67V	Wind Driven Rain Fixed Drainable	V	1.63	6.00	7.73	48	1250	0.17	7200	688
LE-68V	Wind Driven Rain Fixed Drainable	V	1.63	6.00	7.85	49	1250	0.16	9813	980
LE-69	Wind Driven Rain Fixed Drainable	H	2.00	6.00	8.02	50	1250	0.44	10025	376
LE-73	Wind Driven Rain Fixed Drainable	H	3.50	7.00	7.36	46	649	0.18	4777	201



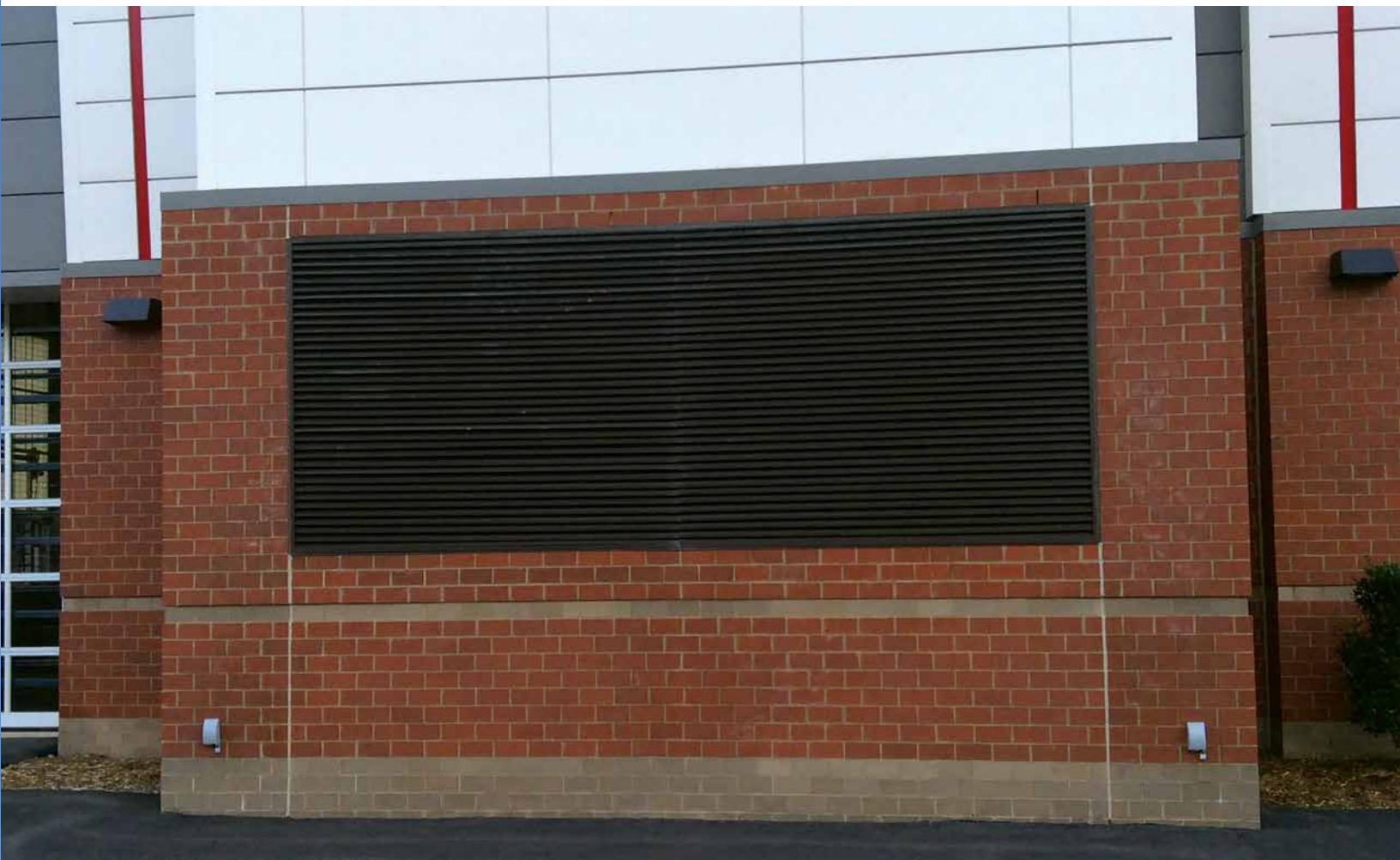

Close-King Indoor Practice Facility - LE-69

Model	Description	Material Thickness (Frame/Blade) Inches	Wind Driven Rain Performance @ 29 mph			Certification Rating			Single Panel Size	
			Class A,B,C or D	Effectiveness	Coefficient of Discharge	AMCA	Miami Dade	Sight Proof	Min W x h Inches	Max W x H Inches
LE-29	Wind Driven Rain Fixed Drainable	0.061 / 0.056	A	99.2	class 3	Y	-	Y	12 x 12	96 x 96
LE-42	Wind Driven Rain Fixed Drainable	0.081 / 0.081	A*	100.0	class 3	Y	-	Y	12 x 12	96 x 96
LE-44	Wind Driven Rain Fixed Drainable	0.081 / 0.060	A	100.0	class 1	Y	-	Y	12 x 12	96 x 96
LE-53	Wind Driven Rain Fixed Drainable	0.081 / 0.060	A	99.0	class 3	Y	-	Y	12 x 12	96 x 96
LE-54	Wind Driven Rain Fixed Drainable	0.078 / 0.060	A	99.0	class 3	Y	Y	Y	12 x 12	60 x 96
LE-59	Wind Driven Rain Fixed Drainable	0.081 / 0.060	A	99.5	class 2	Y	-	Y	12 x 12	96 x 96
LE-62	Wind Driven Rain Fixed Drainable	0.081 / 0.081	A	99.7	class 3	Y	-	Y	12 x 12	96 x 96
LE-67V	Wind Driven Rain Fixed Drainable	0.081 / 0.081	A*	99.5	class 1	Y	-	Y	12 x 12	96 x 96
LE-68V	Wind Driven Rain Fixed Drainable	0.125 / 0.081	A	100.0	class 1	Y	Y	Y	12 x 12	96 x 96
LE-69	Wind Driven Rain Fixed Drainable	0.081 / 0.060	A	100.0	class 1	Y	-	Y	12 x 12	96 x 96
LE-73	Wind Driven Rain Fixed Drainable	0.081 / 0.081	A	99.0	class 4	Y	-	Y	12 x 12	96 x 96

**Notes:**

AMCA certified performance based on 4' x 4' louver

Standard construction designed for 25 PSF (100 mph) wind load for maximum single panel size

\* Wind driven rain performance @50 MPH



# Hurricane Louvers

Hurricane Architectural louvers are offered in a variety of frame depths, blade angles and spacing. All hurricane rated louvers are Miami Dade County Certified.



Model	Description	Blade			Frame Depth Inches	Free Area		Water Penetration Rating (WPR) Feet/minute	Pressure Drop @ WPR inches W.C.	Air Flow SCFM	Material Thickness (Frame/ Blade) Inches	Certification Rating			Single Panel Size	
		Orientation H - Horiz. V - Vert.	Angle Deg.	Spacing Inches		Sq. Ft.	%					AMCA	Miami Dade	Sight Proof	Min W x H Inches	Max W x H Inches
LE-22	Hurricane Fixed Drainable	H	45.0	5.00	4.00	8.37	52	1075	0.15	8998	0.125 / 0.125	Y	Y	-	12 x 12	60 x 96
LE-32	Hurricane Fixed Drainable	H	37.5	4.00	6.00	9.24	58	1193	0.20	11023	0.125 / 0.081	Y	Y	-	12 x 12	96 x 96
LE-32C	Hurricane Combination Drainable	H	37.5	4.00	6.00	8.19	51	1250	0.15	10240	0.125 / 0.081	Y	Y	-	12 x 12	60 x 96
LE-54	Hurricane Wind Driven Rain Fixed Drainable	H	-	2.00	5.00	7.08	44	1250	0.31	8850	0.078 / 0.060	Y	Y	Y	12 x 12	60 x 96
LE-68V	Hurricane Wind Driven Rain Fixed Drainable	V	-	1.63	6.00	7.85	49	1250	0.16	9813	0.125 / 0.081	Y	Y	Y	12 x 12	96 x 96

**Notes:**

AMCA certified performance based on 4' x 4' louver

Standard construction designed for 25 PSF (100 mph) wind load for maximum single panel size



# FEMA Louvers



AWV offers two different FEMA louvers in different frame depths. Both the LE-F5 and LF-F8 are high performance louvers which are compliant with fema 361 second edition and icc 500-2008. FEMA louvers provide optimum protection for storm shelters and safe rooms.



Model	Description	Blade			Frame Depth Inches	Free Area		Water Penetration Rating (WPR) Feet/minute	Pressure Drop @ WPR inches W.C.	Air Flow SCFM	Material Thickness (Frame/Blade) Inches	Certification Rating			Single Panel Size	
		Orientation H - Horiz. V - Vert.	Angle Deg.	Spacing Inches		Sq. Ft.	%					AMCA	Miami Dade	Sight Proof	Min W x H Inches	Max W x H Inches
LE-F5	FEMA	H	-	-	5.50	7.89	49.3				0.25 / 0.25	Y	-	Y	12 x 12	90 X 90 Continuous wide 78 X 90 Continuous high
LF-F8	FEMA	H	-	-	8.00	8.47	53				0.25 / 0.25	Y	-	Y	12 x 12	96 X 76 Continuous wide 76 X 120 Continuous high

**Notes:**

AMCA certified performance based on 4' x 4' louver

Standard construction designed for 25 PSF (100 mph) wind load for maximum single panel size





# Grilles / Vision Screens





Apple Campus 2 R&D Building - LS-47

#### AWV'S OFFERING



##### Aesthetically Pleasing

AWV architectural grilles and vision screens are designed with aesthetics in mind.



##### Wide Range

AWV products are available in a wide variety of shapes, sizes, materials, finishes and coatings to meet the requirements of any project.



##### Durability

AWV can provide certified structural calculations when requested to ensure structural integrity.

The purpose of architectural grilles is to offer the architect aesthetic flexibility to enhance the building's appearance. Common applications include:

- Decorative treatment on a building's façade.
- Parking garages for ventilation and limiting visibility into the garage.

Vision Screens are most often used to limit the visibility of mechanical equipment on or near the building. Whether for new construction or resurfacing of an existing building, AWV's broad line architectural grilles and vision screens address these design objectives.



# Grilles / Vision Screens

## STANDARD FINISHES

AWV architectural grilles and vision screens can be provided in mill, anodized, baked enamel, PVDF (aka Kynar) and other special finishes. AWV is a licensed applicator for Akzo Nobel, PPG and Valspar to meet AAMA painting (2603, 2604 & 2605) specifications.

Clear anodizing provides a uniform satin finish that resists oxidation. The 204R1 clear provides a 0.4 mil coating, while the 215R1 clear provides a 0.7 mil coating for extra corrosion and abrasion resistance. Color anodizing is also available in light, medium, dark bronze or black in a 0.7 mil coating.

PVDF (aka Kynar) is a baked-on finish made of 70% PVDF resins and durable ceramic pigments that meets AAMA2605 specifications. PVDF is unsurpassed in its resistance to color fading and chalking from the damaging ultraviolet rays of the sun. It is resistant to general air pollution and will not whiten or pit when exposed to the elements.

PVDF finishes are available in a wide range of colors and glosses. Metallic, pearlescent and other more exotic formulations are also available. Refer to AWV's Standard Finish Color Selection brochure (ASFCS-B-1) for our standard choice of colors. Special color matching can also be provided by our in-house computerized paint color formulating system.

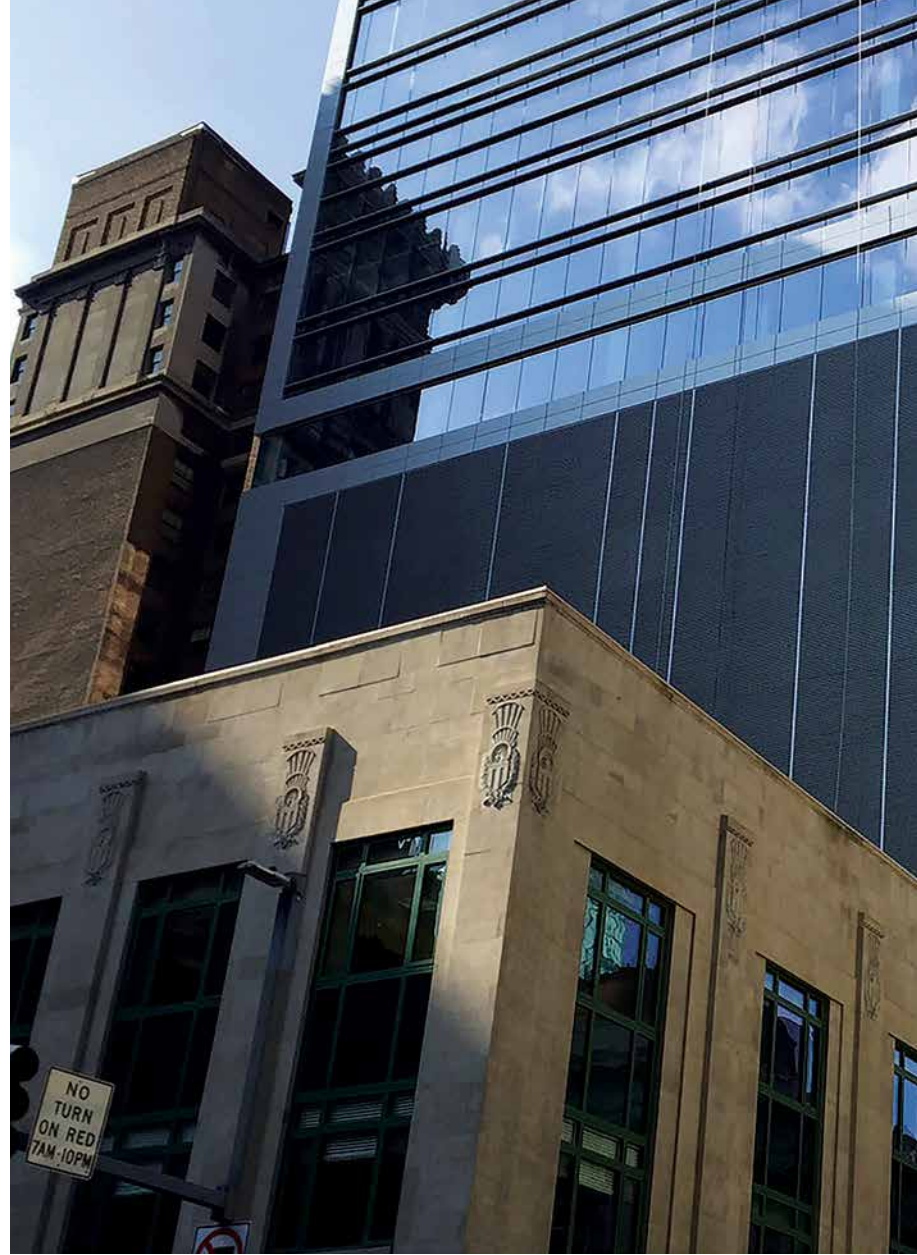

The Gardens at Market Square - LS-57

## CUSTOM FINISHES

While architectural grilles and vision screens are typically constructed of extruded aluminum, special appearances can be provided through a dye-sublimation process to turn ordinary materials into a work of art. We transform the aluminum to look identical to wood grain, marble, granite, masonry, carbon fiber or any creative digital design to give your project a unique signature appearance.



## LEAD TIMES / QUICK DELIVERY

AWV offers competitive and short lead times. In addition, quick ship programs are available on selected models for extra fast delivery.



# Architectural Grilles

## STYLES

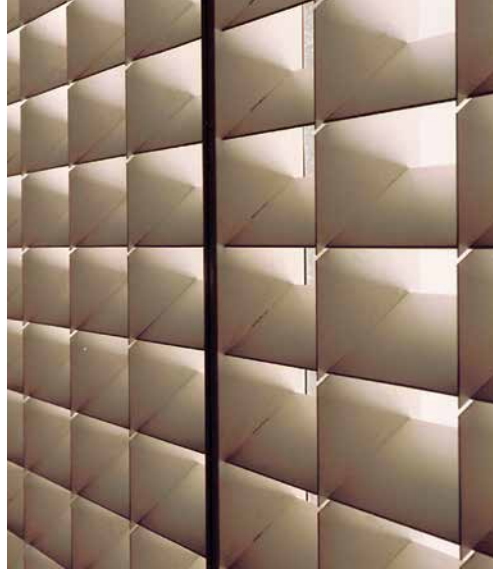

Egg Crate in varying dimensions

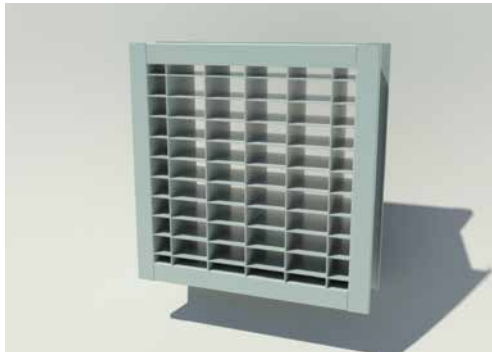

Starburst in varying dimensions

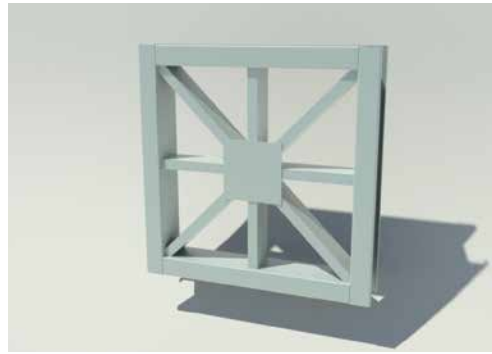

Diamond in varying dimensions

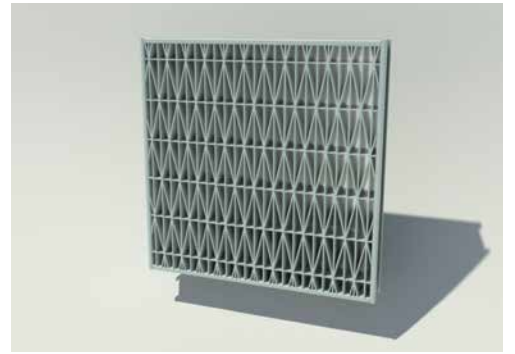

Double Lattice in varying dimensions

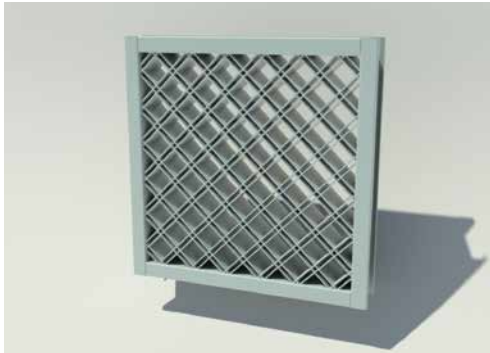

Modular Bold in varying dimensions



Myriad Staggered in varying dimensions

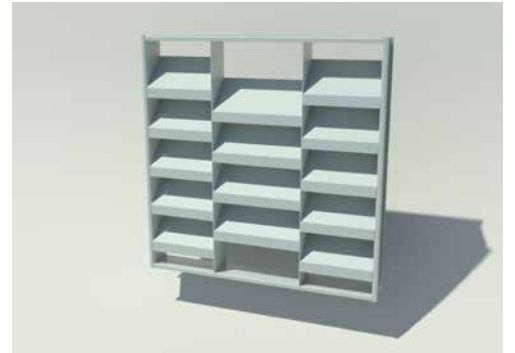

Lattice in varying dimensions

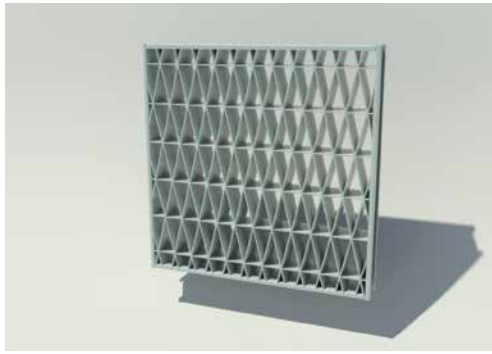

Myriad Continuous in varying dimensions

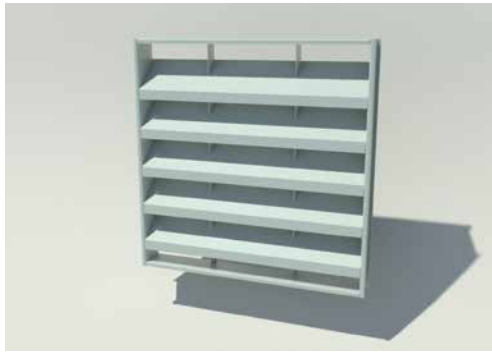

Sentry in varying dimensions

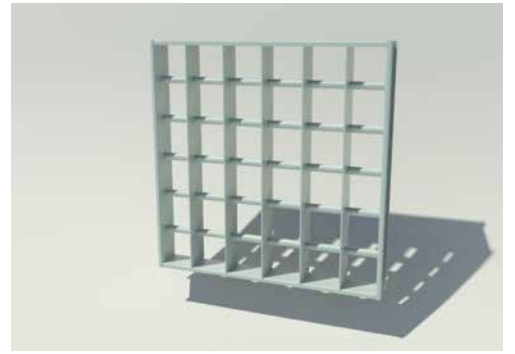

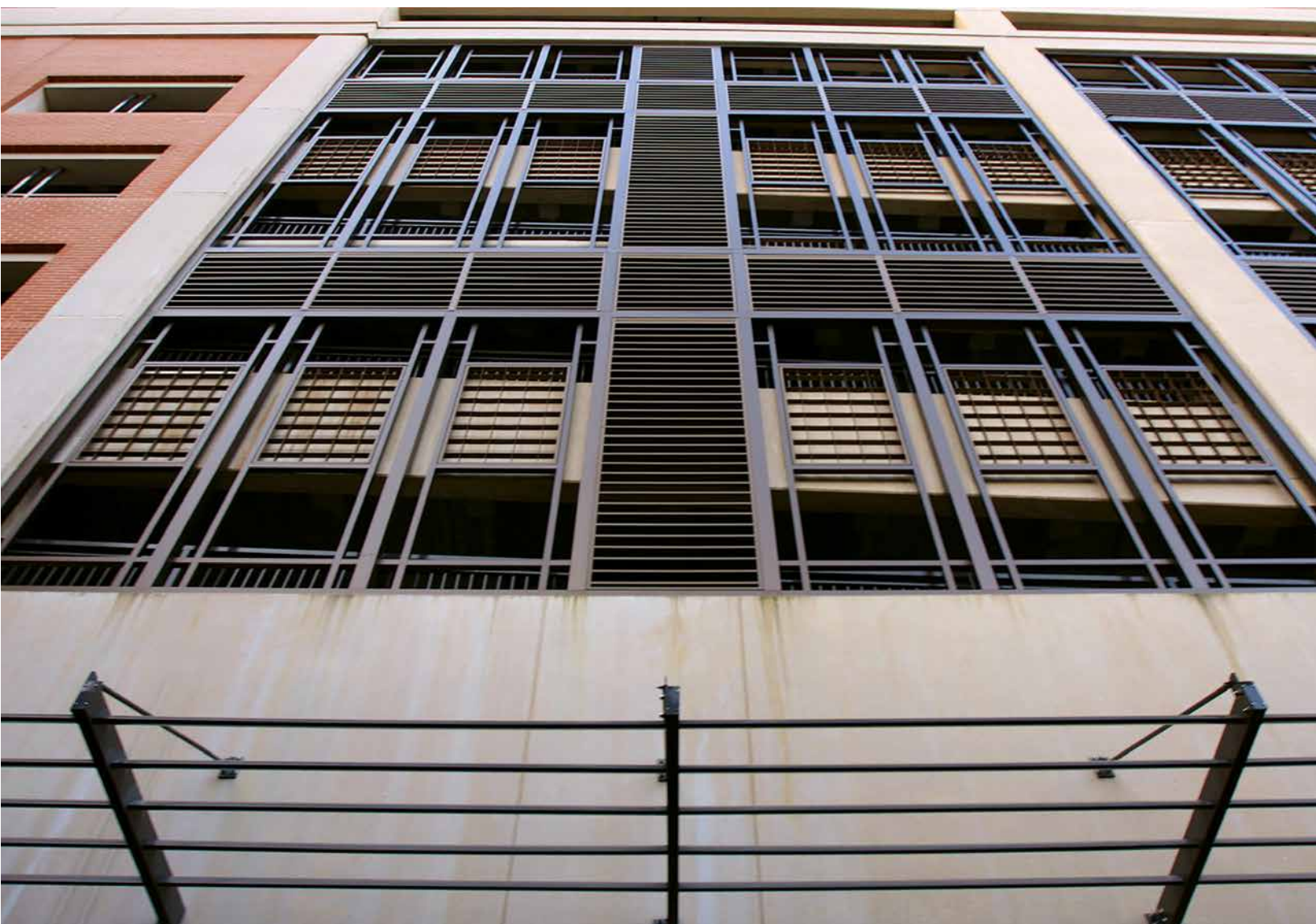



# Architectural Vision Screens

## STYLES



LS-10

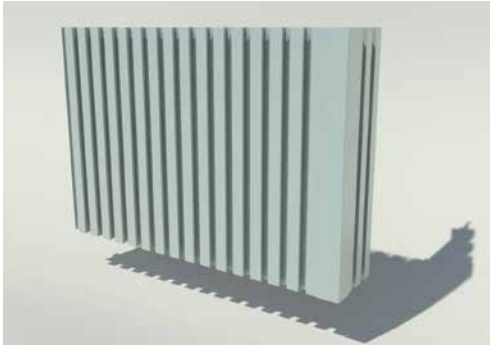

LS-47

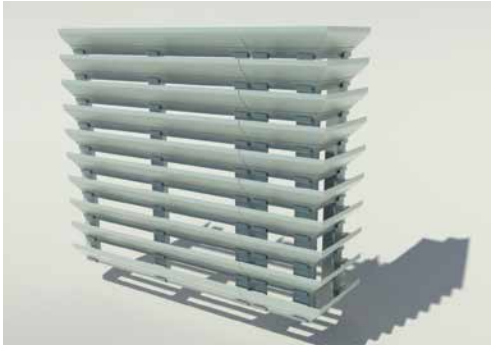

LS-81H

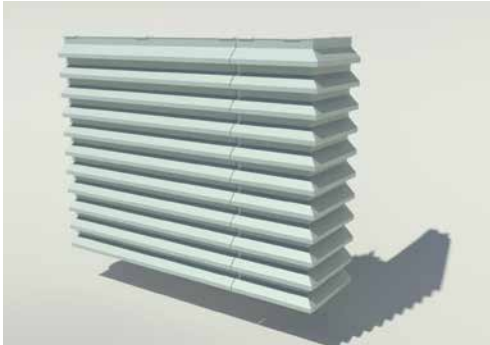

LS-40H

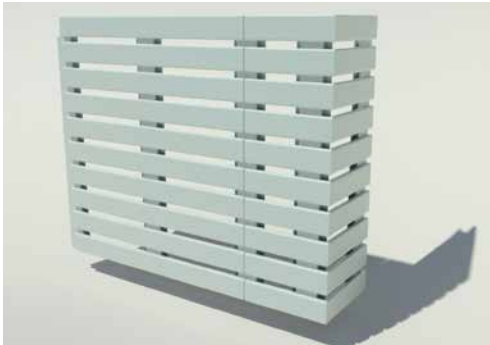

LS-52V

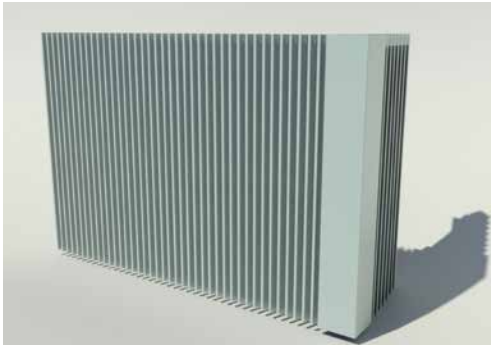

LS-81V

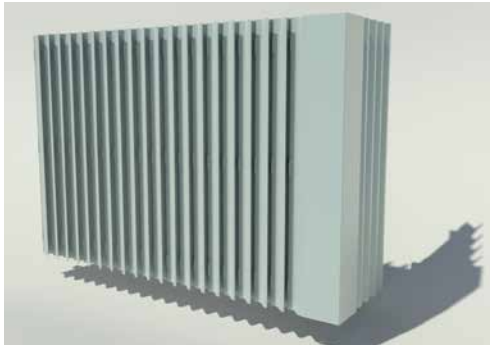









# Sunshades



The purpose of fixed sunshades is to give the architect aesthetic flexibility to beautify the building's appearance, while providing a degree of solar shading. AWW offers an extraordinary range of fixed sunshades in a variety of shapes, finishes, and mounting arrangements for a dramatic aesthetic effect.

## AWW'S OFFERING

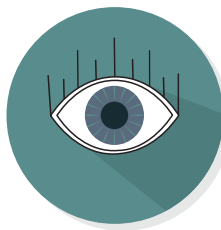

### Aesthetically Pleasing

AWW fixed sunshades are designed with aesthetics foremost in mind.



### Wide Range

AWW fixed sunshades are available in a wide variety of shapes, patterns and sizes for the blades or in-fill panels, outriggers and fascia styles.



### Reduced Energy Costs

AWW fixed sunshades provide a degree of solar shading reducing cooling loads and energy costs.



### Durability

Virtually maintenance-free light weight extruded aluminum construction. AWW can provide certified structural calculations when requested to ensure sunshade structural integrity. AWW fixed sunshades are typically manufactured using non-welded construction, but welded construction can also be provided if desired.



## SPECIFYING YOUR SUNSHADE

Specifying fixed sunshades has never been easier. Simply select the blades/infill grille or panel, outriggers, fascia and options.

To begin the section, chose either the blades or infill grilles/panels.

### Choose Blades

Blade style and width size

Number of blades

Blade mounting angle (i.e. 90 degrees is horizontal, 45 degrees is up, 135 degrees is down).

OR

### Choose Infill Grille/Panels

Grille or panel style

### Choose Outriggers

Outrigger projection depth, style and spacing along the length of the sunshade.

Outrigger mounting angle (i.e. 90 degrees is horizontal, 45 degrees is up, 135 degrees is down).

Outrigger height at building façade and at end.

### Choose Fascia (if any)

None – The sunshade will be terminated with the last blade.

Fascia style and size.

### Choose Downrigger (if any)

Mounting height above sunshade

### Choose Overall Length

### Choose Finish

Refer to AWV's Standard Finishes brochure.

### Choose Special Options

Inside mitered corners (specify angle)

Outside mitered corners (specify angle)

Curved (specify radius)



## CUSTOM FINISHES

While fixed sunshades are typically constructed of extruded aluminum, special appearances can be provided through a dye-sublimation process to turn ordinary materials into a work of art. We transform the aluminum to look identical to wood grain, marble, granite, masonry, carbon fiber or any creative digital design to give your project a unique signature appearance.

## STANDARD FINISHES

AWV fixed sunshades can be provided in mill, anodized, baked enamel, PVDF (aka Kynar) and other special finishes. AWV is a licensed applicator for Akzo Nobel, PPG and Valspar to meet AAMA painting (2603, 2604 & 2605) specifications.

Clear anodizing provides a uniform satin finish that resists oxidation. The 204R1 clear provides a 0.4 mil coating, while the 215R1 clear provides a 0.7 mil coating for extra corrosion and abrasion resistance. Color anodizing is also available in light, medium, dark bronze or black in a 0.7 mil coating.

PVDF (aka Kynar) is a baked-on finish made of 70% PVDF resins and durable ceramic pigments that meets AAMA2605 specifications. PVDF is unsurpassed in its resistance to color fading and chalking from the damaging ultraviolet rays of the sun. It is resistant to general air pollution and will not whiten or pit when exposed to the elements.

PVDF finishes are available in a wide range of colors and glosses. Metallic, pearlescent and other more exotic formulations are also available. Refer to AWV's Standard Finish Color Selection brochure for our standard choice of colors. Special color matching can also be provided by our in-house computerized paint color formulating system.





# Sunshades

## BLADE STYLE AND SIZES



Full Airfoil – 2-12" widths in 1" increments, plus larger widths up to 24" in 4" increments.



Tear Drop – 4-10" widths in 1" increments

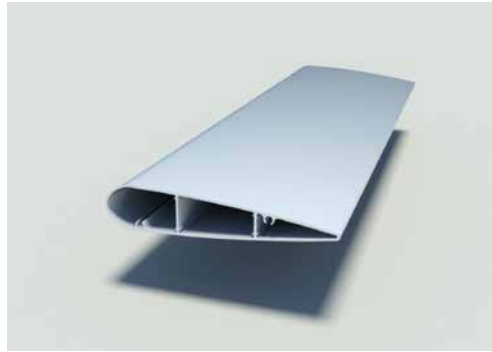

Round – 1-12" diameters in 1" increments



Half Airfoil – 6-12" widths in 1" increments

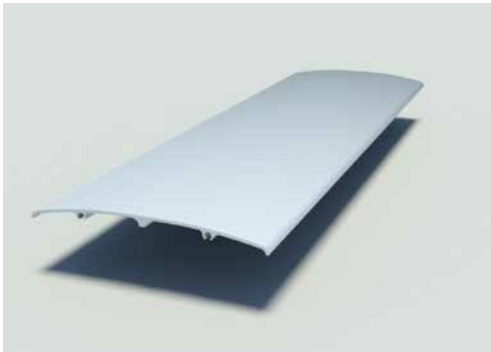

Rectangular Tube – 1-8" widths in 1" increments

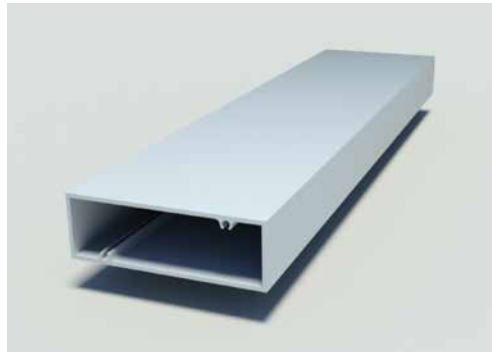

Louver – 2-8" width in 1" increments

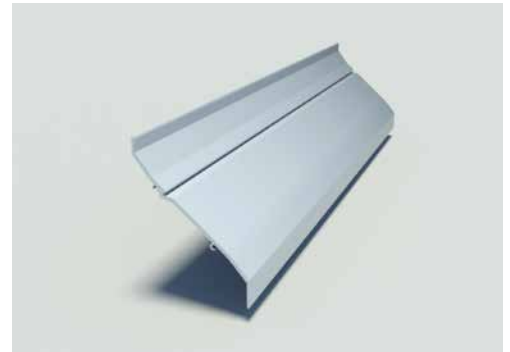

Wedge – 4-10" widths in 1" increments

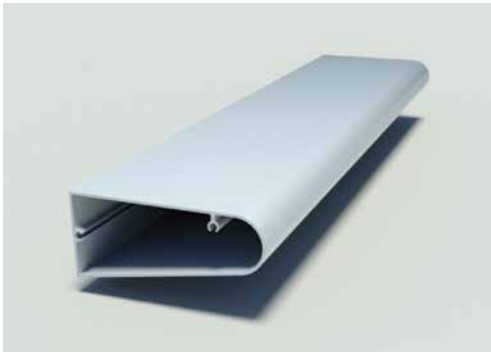

Square – 1' x 1"- 6" x 6" in 1" increments



Flat – 4-8" widths in 1" increments

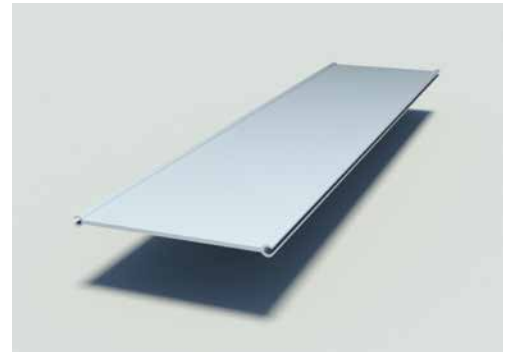

## INFILL GRILLES

Instead of using blades, in-fill grilles are available in a variety of patterns.

Egg Crate in varying dimensions



Lattice in varying dimensions

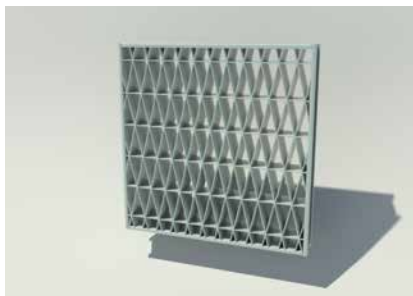

Double Lattice in varying dimensions



Starburst in varying dimensions

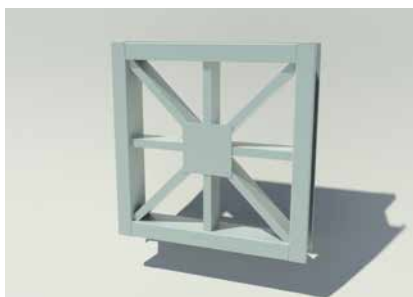

## INFILL PERFORATED PANELS

In-fill perforated panels are also available.

Square holes, straight centers in varying dimensions

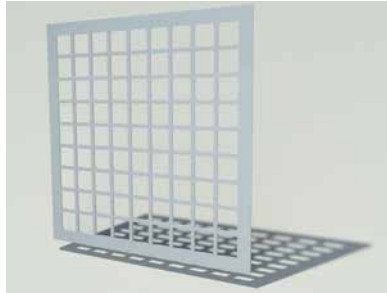

Round holes, 60° staggered centers in varying dimensions



Round holes, straight centers in varying dimensions

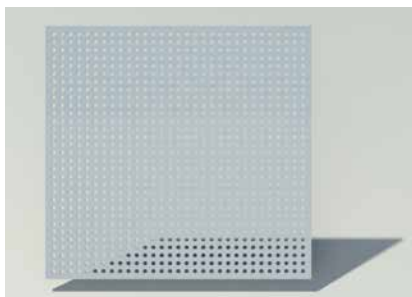

Slotted holes, staggered centers in varying dimensions



## FACIA STYLES AND SIZES

The sunshade's last blade can terminate the sunshade or with a fascia shape including:

Wedge – 4-10" widths in 1" increments



Bullnose – 4-10" widths in 1" increments



Rectangular – 1-8" widths in 1" increments

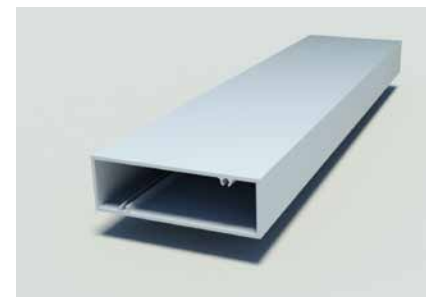

Round – 1-12" diameters in 1" increments





# Sunshades

## OUTRIGGER STYLES AND SIZES

The blades and fascia are supported by outriggers mounted to the building's façade. An unlimited number of sizes and shapes are available. The following are a sampling.

Rectangular in varying dimensions



Rounded in varying dimensions

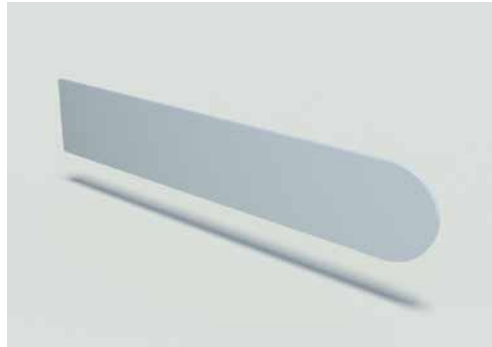

Curved in varying dimensions

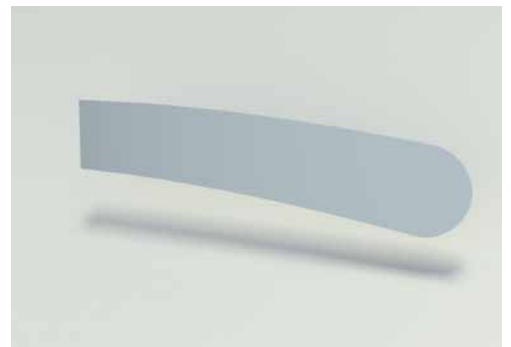

Bullnose in varying dimensions

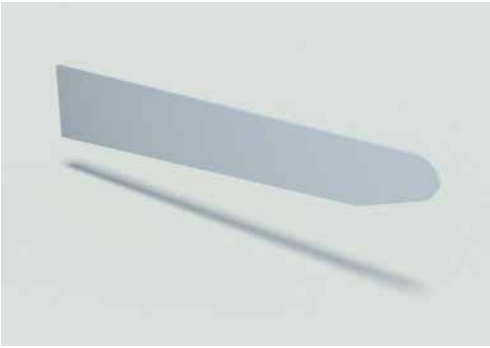

Sloped in varying dimensions

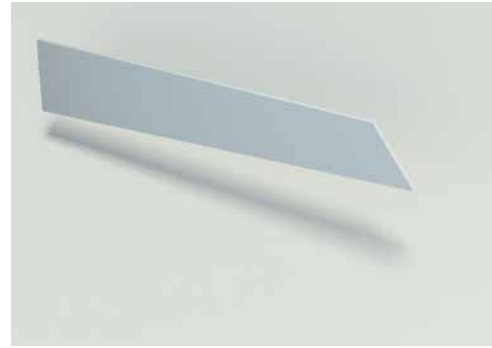

Wedge in varying dimensions

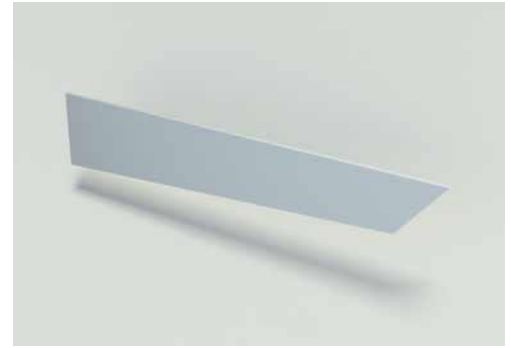

Profiled in varying dimensions

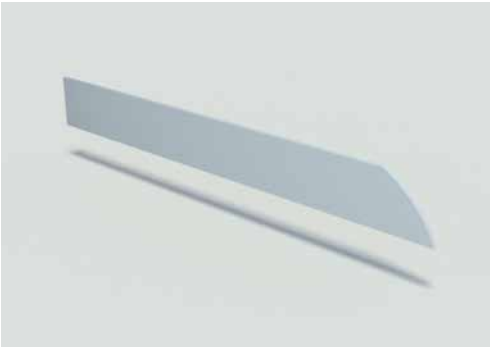

Tapered in varying dimensions

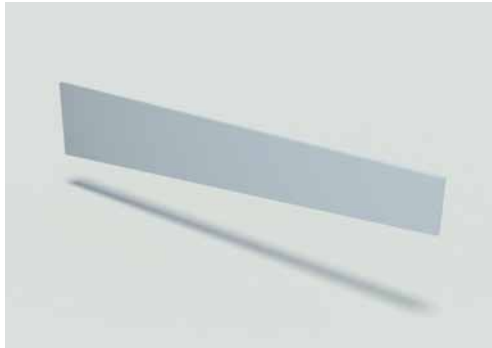

## DOWNRIGGERS

Downriggers are normally threaded rods attached to the building façade through a mounting bracket located above the sunshade and attached to the end of the sunshade.

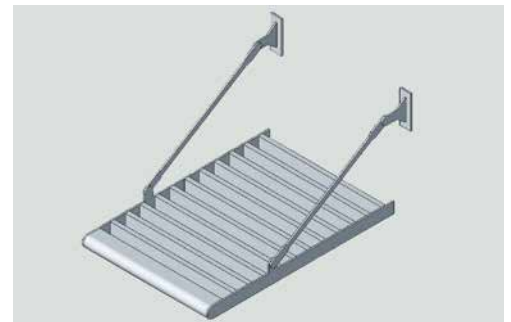

# MOUNTING METHODS

## MOUNTING METHODS

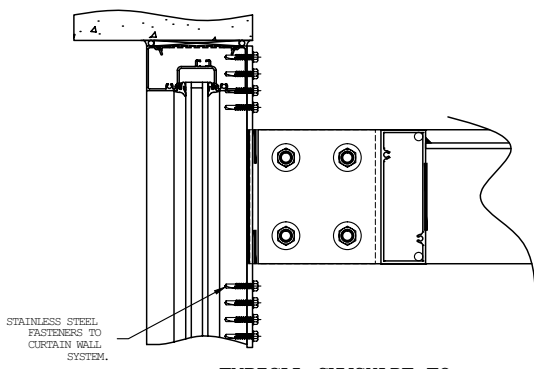

TYPICAL SUNSHADE TO CURTAIN WALL INSTALLATION

STEEL PLATE AND STAINLESS STEEL BOLTS TO MASONRY WALL SYSTEM.

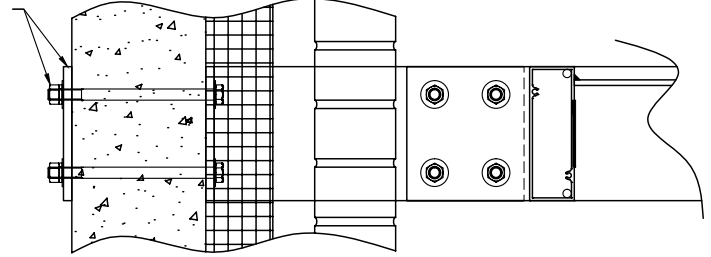

TYPICAL SUNSHADE TO MASONRY INSTALLATION

STAINLESS STEEL ANCHERS TO PRE-CAST WALL SYSTEM.

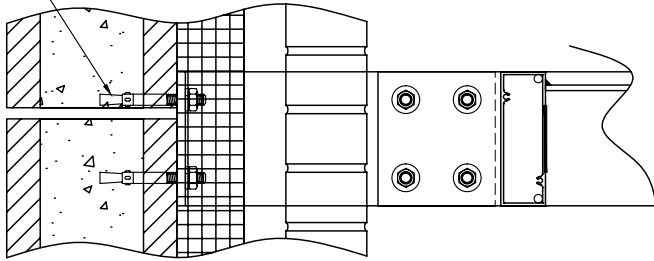

TYPICAL SUNSHADE TO PRE-CAST INSTALLATION

STAINLESS STEEL BOLTS TO STEEL TUBE WALL SYSTEM

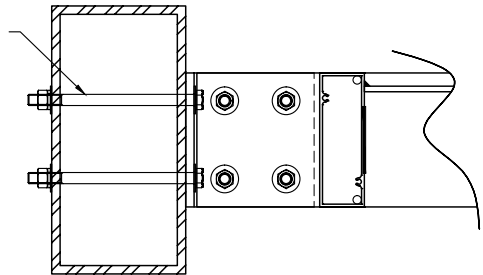

TYPICAL SUNSHADE TO STEEL SUPPORT INSTALLATION







# Penthouses

The purpose of penthouses is to provide ventilation or exhaust air, while offering defense against vision, water and noise intrusion. In addition, the penthouse designs must give the architect aesthetic flexibility to enhance the building's appearance. AWV's broad line of penthouses address these design objectives.



## STANDARD FEATURES, OPTIONS AND ACCESSORIES

AWV offers a wide selection of options and accessories to simplify installation and provide the functionality required.

- Shipped completely factory assembled (up to maximum cataloged penthouse throat size).
- Varying blade spacing and angles.
- Aluminum insect/bird screens with mounting either in the interior or on the exterior, with options for galvanized steel and stainless steel.
- Flat or pitched hinged roofs with internal insulation.
- Option for blank-off panels.
- Non-welded or welded construction.

## AWV'S OFFERING

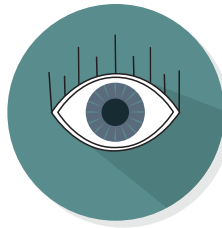

### Aesthetically Pleasing

AWV penthouses are designed with aesthetics in mind.



### Wide Range

AWV penthouses are available in a wide variety of shapes, sizes, materials, finishes and coatings to meet the requirements of any project.



### Reduced Energy Costs

AWV's penthouses are highly aerodynamically efficient. The low air resistance reduces the fan energy required to introduce the ventilation air into the building.



### Durability

AWV can provide certified structural calculations when requested to ensure penthouse structural integrity. All penthouses are constructed of aluminum.



# Penthouses

## STANDARD FINISHES

AWV penthouses can be provided in mill, anodized, baked enamel, PVDF (aka Kynar) and other special finishes. AWV is a licensed applicator for Akzo Nobel, PPG and Valspar to meet AAMA painting (2603, 2604 & 2605) specifications.

Clear anodizing provides a uniform satin finish that resists oxidation. The 204R1 clear provides a 0.4 mil coating, while the 215R1 clear provides a 0.7 mil coating for extra corrosion and abrasion resistance. Color anodizing is also available in light, medium, dark bronze or black in a 0.7 mil coating.

PVDF (aka Kynar) is a baked-on finish made of 70% PVDF resins and durable ceramic pigments that meets AAMA2605 specifications. PVDF is unsurpassed in its resistance to color fading and chalking from the damaging ultraviolet rays of the sun. It is resistant to general air pollution and will not whiten or pit when exposed to the elements.

PVDF finishes are available in a wide range of colors and glosses. Metallic, pearlescent and other more exotic formulations are also available. Refer to AWV's Standard Finishes Color Selection brochure for our standard choice of colors. Special color matching can be provided by our in-house computerized paint color formulating system.



## CUSTOM FINISHES

While penthouses are typically constructed of extruded aluminum, special appearances can be provided through a dye-sublimation process to turn ordinary materials into a work of art. We transform the aluminum to look identical to wood grain, marble, granite, masonry, carbon fiber and any creative digital design to give your project a unique signature appearance.





# Penthouses



## FIXED DRAINABLE PENTHOUSES

Fixed drainable extruded aluminum penthouses in a variety of frame depths, blade angles and spacing. They are appropriate for both intake and exhaust applications.

Model	Description	Blade			Frame Depth Inches	Material Thickness			Penthouse Throat Size	
		Orientation H - Horiz. V - Vert.	Angle Deg.	Spacing Inches		Frame Inches	Blade Inches	Roof Inches	Min W x L x H Inches	Max W x L x H Inches
PE-21	Boxed Corners Fixed Drainable	H	45.0	5.00	4.00	0.081	0.081	0.050	12 x 12 x 12	84 x 84 x 60
PE-23	Boxed Corners Fixed Drainable	H	37.5	3.50	4.00	0.081	0.081	0.050	12 x 12 x 12	84 x 84 x 60
PE-31	Boxed Corners Fixed Drainable	H	37.5	4.00	6.00	0.081	0.081	0.050	12 x 12 x 12	84 x 84 x 60
PE-33	Boxed Corners Fixed Drainable	H	45.0	7.00	6.00	0.081	0.081	0.050	12 x 12 x 12	84 x 84 x 60

Notes: Penthouses with larger throat sizes are available shipped knocked-down.

## FIXED NON-DRAINABLE PENTHOUSES

Fixed non-drainable extruded aluminum penthouses are offered in a variety of frame depths, blade angles and spacing. Either boxed or mitered corners are available. They are usually most appropriate for exhaust applications.



Model	Description	Blade			Frame Depth Inches	Material Thickness			Penthouse Throat Size	
		Orientation H - Horiz. V - Vert.	Angle Deg.	Spacing Inches		Frame Inches	Blade Inches	Roof Inches	Min W x L x H Inches	Max W x L x H Inches
PE-47B	Boxed Corners Fixed Non-drainable	H	45.0	5.00	4.00	0.081	0.081	0.050	12 x 12 x 12	84 x 84 x 60
PE-47M	Mitered Corners Fixed Non-drainable	H	45.0	5.00	4.00	0.081	0.081	0.050	12 x 12 x 12	84 x 84 x 60
PE-63B	Boxed Corners Fixed Non-drainable	H	45.0	7.00	6.00	0.081	0.081	0.050	12 x 12 x 12	84 x 84 x 60
PE-63M	Mitered Corners Fixed Non-drainable	H	45.0	7.00	6.00	0.081	0.081	0.050	12 x 12 x 12	84 x 84 x 60

Notes: Penthouses with larger throat sizes are available shipped knocked-down.





**awv**  
architectural



 @AmericanWarming  
 facebook.com/AWV.USA  
 linkedin.com/company/american-warming-&-ventilating-a-mestek-company



7301 International Drive, Holland, Ohio 43528, USA  
www.awv.com | Email: info@awv.com  
Phone: 419-865-5000 | Fax: 419-865-1375