



PANEL RADIATOR INSTALLATION, OPERATION & MAINTENANCE MANUAL

ATTENTION: READ THESE INSTRUCTIONS CAREFULLY BEFORE ATTEMPTING TO INSTALL, OPERATE, OR SERVICE. RETAIN THESE INSTRUCTIONS FOR FUTURE REFERENCE.

INSPECT THE SHIPMENT IMMEDIATELY WHEN RECEIVED TO DETERMINE IF ANY DAMAGE HAS OCCURRED DURING SHIPMENT.



260 NORTH ELM STREET, WESTFIELD, MASSACHUSETTS 01085
7555 TRANMERE DRIVE, MISSISSAUGA, ONTARIO L5S 1L4 CANADA

Section 1: General Information

Important Information

Inspect Panel Radiator and all contents for damage prior to installation. There will be 2 boxes. One contains the panel radiator and one contains necessary mounting hardware and radiator accessories. If additional accessories were ordered, they will arrive in a 3rd box check your packing slip for more information.

Accessory Box Contents

- **Insert Pack containing: 1 Valve insert, 1 valve insert cover, 1 drain cover (see Fig. 1)**
- **Type 11 only - L Bracket Installation Kit containing: 2 brackets, 4 wall anchors, 4 bolts, 1 air vent, 1 drain cover, 2 plastic locking clips, 4 plastic U inserts (2 needed, 2 extra) (see Fig. 2)**
- **Type 21/22/33 only – J Bracket Installation Kit containing: 2 J Brackets, 4 wall anchors, 4 bolts, 1 air vent, 1 drain cover (see Fig. 3)**

PLEASE NOTE: Any 70" (1800 mm) panel radiator will require the installation of a 3rd bracket in the center of the unit. These units will come with 2 bracket kits. Only 1 bracket needs to be used from the 2nd kit.

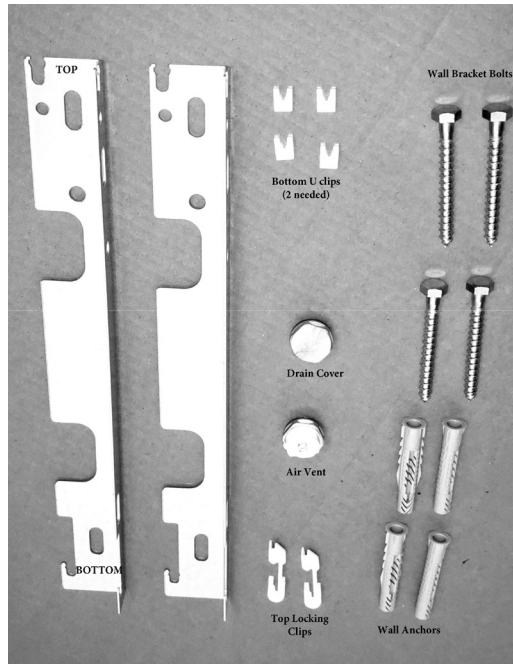

Figure 2 – L Bracket Kit



Figure 1 – Insert Pack Contents

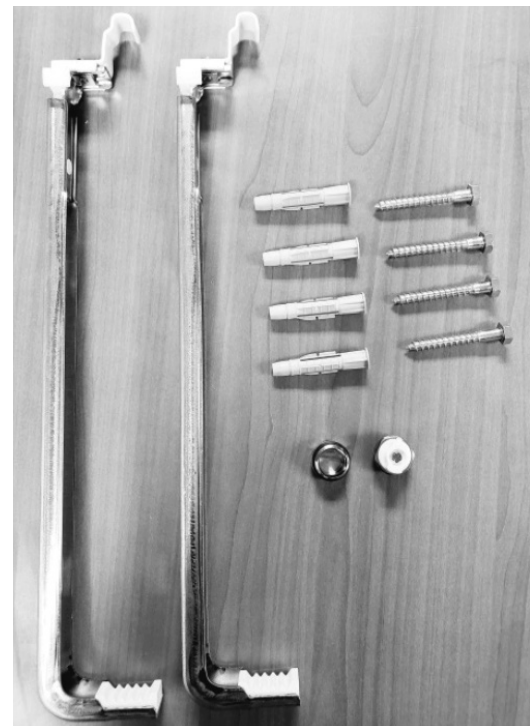

Figure 3 – J Bracket Kit

Section 2: Specifications and Ratings

Type	Part Number	Depth	Dimensions (HxL)		Output (BTU) @120°F	Output (BTU) @140°F	Output (BTU) @160°F	Output (BTU) @180°F	Weight (lbs)	Water Content (gal)	Equivalent Baseboard @180°F (ft)
			In.	mm							
11	5136U1150040100	2-3/4	19 11/16 x 15 3/4	500 x 400	506	810	1,139	1,472	13	0.29	3
	5136U1150060100		19 11/16 x 23 5/8	500 x 600	758	1,215	1,708	2,207	18	0.44	4
	5136U1150070100		19 11/16 x 27 9/16	500 x 700	887	1,419	1,991	2,575	22	0.50	5
	5136U1150090100		19 11/16 x 35 7/16	500 x 900	1,140	1,824	2,560	3,311	26	0.66	6
	5136U1150100100		19 11/16 x 39 3/8	500 x 1000	1,268	2,024	2,847	3,678	29	0.73	7
	5136U1160060100		23 5/8 x 23 5/8	600 x 600	922	1,490	2,093	2,731	22	0.52	5
	5136U1160070100		23 5/8 x 27 9/16	600 x 700	1,081	1,737	2,444	3,189	24	0.60	6
	5136U1160090100		23 5/8 x 35 7/16	600 x 900	1,389	2,237	3,145	4,104	31	0.76	8
21	5136U2640040000	2-7/8	15 3/4 x 15 3/4	400 x 400	583	927	1,280	1,654	15	0.47	3
	5136U2640060000		15 3/4 x 23 5/8	400 x 600	875	1,391	1,921	2,484	22	0.71	5
	5136U2640070000		15 3/4 x 27 9/16	400 x 700	1,019	1,622	2,239	2,895	26	0.84	6
	5136U2640090000		15 3/4 x 35 7/16	400 x 900	1,311	2,083	2,879	3,726	33	1.08	7
	5136U2640100000		15 3/4 x 39 3/8	400 x 1000	1,454	2,313	3,197	4,138	37	1.18	8
	5136U2640120000		15 3/4 x 47 1/4	400 x 1200	1,749	2,778	3,841	4,968	44	1.42	9
	5136U2640140000		15 3/4 x 55 1/8	400 x 1400	2,038	3,239	4,477	5,775	51	1.66	10
	5136U2640180000		15 3/4 x 70 7/8	400 x 1800	2,621	4,166	5,755	7,448	64	2.16	13
	5136U2650040000		19 11/16 x 15 3/4	500 x 400	699	1,114	1,558	2,002	20	0.58	4
	5136U2650060000		19 11/16 x 23 5/8	500 x 600	1,047	1,674	2,340	3,009	29	0.87	6
	5136U2650070000		19 11/16 x 27 9/16	500 x 700	1,223	1,951	2,730	3,507	33	1.03	7
	5136U2650090000		19 11/16 x 35 7/16	500 x 900	1,570	2,507	3,508	4,511	41	1.32	8
	5136U2650100000		19 11/16 x 39 3/8	500 x 1000	1,762	2,814	3,935	5,013	46	1.45	9
	5136U2650140000		19 11/16 x 55 1/8	500 x 1400	2,468	3,935	5,508	6,980	53	1.58	13
	5136U2650180000		19 11/16 x 70 7/8	500 x 1800	3,173	5,064	7,085	9,022	82	2.61	16
	5136U2660040000		23 5/8 x 15 3/4	600 x 400	817	1,303	1,826	2,322	24	0.68	5
	5136U2660060000		23 5/8 x 23 5/8	600 x 600	1,226	1,955	2,734	3,533	33	1.03	7
	5136U2660070000		23 5/8 x 27 9/16	600 x 700	1,431	2,280	3,192	4,120	40	1.21	8
	5136U2660090000		23 5/8 x 35 7/16	600 x 900	1,840	2,935	4,106	5,302	49	1.55	10
	5136U2660100000		23 5/8 x 39 3/8	600 x 1000	2,043	3,257	4,559	5,887	55	1.71	11
5136U2660120000	23 5/8 x 47 1/4	600 x 1200	2,449	3,908	5,471	7,064	66	2.06	13		
5136U2660140000	23 5/8 x 55 1/8	600 x 1400	2,861	4,564	6,386	8,206	77	2.38	15		
22	5136U2230060000	4-1/8	11 13/16 x 23 5/8	300 x 600	825	1,309	1,824	2,358	20	0.55	5
	5136U2230070000		11 13/16 x 27 9/16	300 x 700	962	1,526	2,130	2,750	24	0.66	6
	5136U2230090000		11 13/16 x 35 7/16	300 x 900	1,237	1,966	2,739	3,542	29	0.84	7
	5136U2230100000		11 13/16 x 39 3/8	300 x 1000	1,375	2,182	3,042	3,934	33	0.95	8
	5136U2230120000		11 13/16 x 47 1/4	300 x 1200	1,649	2,619	3,651	4,719	37	1.13	9
	5136U2230130000		11 13/16 x 51 3/16	300 x 1300	1,787	2,839	3,958	5,115	42	1.24	10
	5136U2230140000		11 13/16 x 55 1/8	300 x 1400	1,924	3,056	4,260	5,491	48	1.37	11
	5136U2230180000		11 13/16 x 70 7/8	300 x 1800	2,474	3,932	5,478	7,084	57	1.69	13
	5136U2240040000		15 3/4 x 15 3/4	400 x 400	712	1,132	1,583	2,013	18	0.47	4
	5136U2240060000		15 3/4 x 23 5/8	400 x 600	1,065	1,696	2,374	3,016	26	0.71	6
	5136U2240070000		15 3/4 x 27 9/16	400 x 700	1,242	1,978	2,767	3,518	31	0.84	7
	5136U2240090000		15 3/4 x 35 7/16	400 x 900	1,595	2,546	3,559	4,524	40	1.08	8
	5136U2240100000		15 3/4 x 39 3/8	400 x 1000	1,777	2,828	3,957	5,026	42	1.18	9
	5136U2240120000		15 3/4 x 47 1/4	400 x 1200	2,130	3,396	4,744	6,029	51	1.42	11
	5136U2240140000		15 3/4 x 55 1/8	400 x 1400	2,484	3,960	5,539	7,006	60	1.67	13
	5136U2240180000		15 3/4 x 70 7/8	400 x 1800	3,195	5,096	7,122	9,049	75	2.16	16
	5136U2250040000		19 11/16 x 15 3/4	500 x 400	911	1,458	2,038	2,620	22	0.58	5
	5136U2250060000		19 11/16 x 23 5/8	500 x 600	1,365	2,182	3,053	3,925	33	0.87	7
	5136U2250070000		19 11/16 x 27 9/16	500 x 700	1,593	2,545	3,560	4,580	37	1.03	8
	5136U2250090000		19 11/16 x 35 7/16	500 x 900	2,048	3,274	4,579	5,889	49	1.32	11
	5136U2250100000		19 11/16 x 39 3/8	500 x 1000	2,279	3,636	5,090	6,545	53	1.45	12
	5136U2260040000		23 5/8 x 15 3/4	600 x 400	1,088	1,744	2,448	3,184	26	0.68	6
	5136U2260060000		23 5/8 x 23 5/8	600 x 600	1,633	2,615	3,673	4,781	40	1.03	9
	5136U2260070000		23 5/8 x 27 9/16	600 x 700	1,904	3,050	4,285	5,575	46	1.21	10
	5136U2260090000		23 5/8 x 35 7/16	600 x 900	2,449	3,991	5,605	7,172	57	1.55	13
	5136U2260100000		23 5/8 x 39 3/8	600 x 1000	2,766	4,434	6,228	7,965	64	1.71	14
	5136U2260120000		23 5/8 x 47 1/4	600 x 1200	3,319	5,323	7,474	9,562	75	2.06	17
	5136U2260140000		23 5/8 x 55 1/8	600 x 1400	3,868	6,208	8,719	11,083	86	2.41	20
5136U2260180000	23 5/8 x 70 7/8	600 x 1800	4,976	7,979	11,206	14,335	112	3.09	25		
33	5136U3350060000	6-1/2	19 11/16 x 23 5/8	500 x 600	1,743	2,767	3,929	5,132	49	1.32	9
	5136U3350070000		19 11/16 x 27 9/16	500 x 700	2,035	3,226	4,587	5,988	57	1.53	11
	5136U3350090000		19 11/16 x 35 7/16	500 x 900	2,615	4,146	5,893	7,694	73	1.98	14
	5136U3350100000		19 11/16 x 39 3/8	500 x 1000	2,903	4,608	6,548	8,551	79	2.19	15
	5136U3360060000		23 5/8 x 23 5/8	600 x 600	2,147	3,424	4,785	6,117	60	1.55	11
	5136U3360090000		23 5/8 x 35 7/16	600 x 900	3,221	5,138	7,184	9,177	86	2.32	16
	5136U3360100000		23 5/8 x 39 3/8	600 x 1000	3,577	5,705	7,979	10,199	95	2.58	18
	5136U3360120000		23 5/8 x 47 1/4	600 x 1200	4,293	6,847	9,577	12,237	115	3.09	22
	5136U3360140000		23 5/8 x 55 1/8	600 x 1400	5,011	7,990	11,172	14,213	135	3.60	25
	5136U3360180000		23 5/8 x 70 7/8	600 x 1800	6,441	10,271	14,363	18,355	170	4.64	32

Section 3: Dimensional Drawings

Overall Dimensions

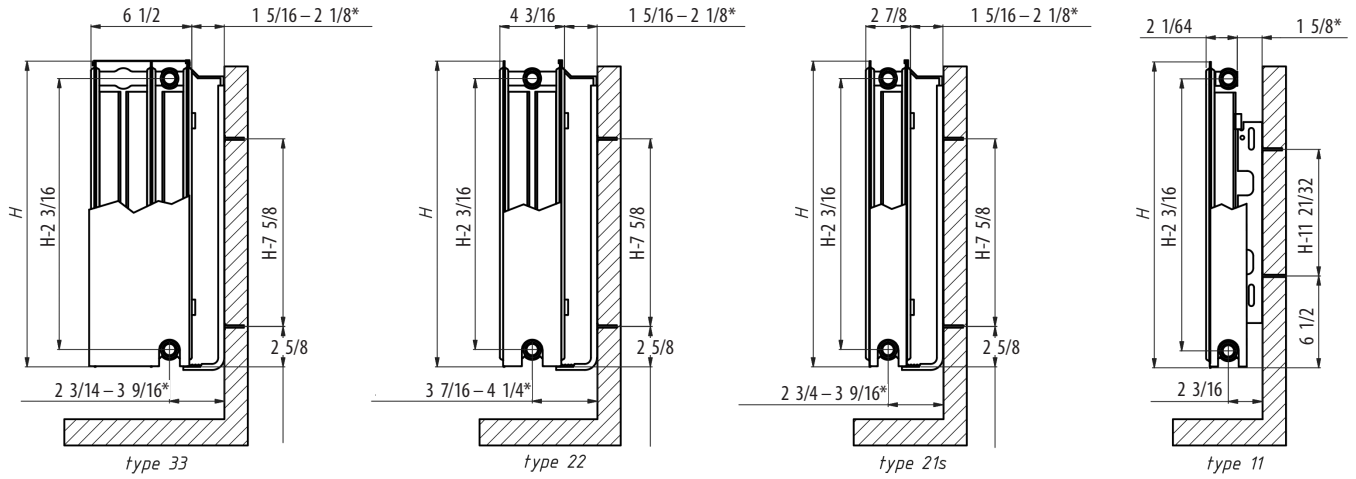

*Distance from wall will vary depending upon placement of radiator on bracket. Bracket depth is adjustable.

H = Height of Radiator (12"/16"/20"/24")

Valve Connection

Dimensions (Valve Connection)

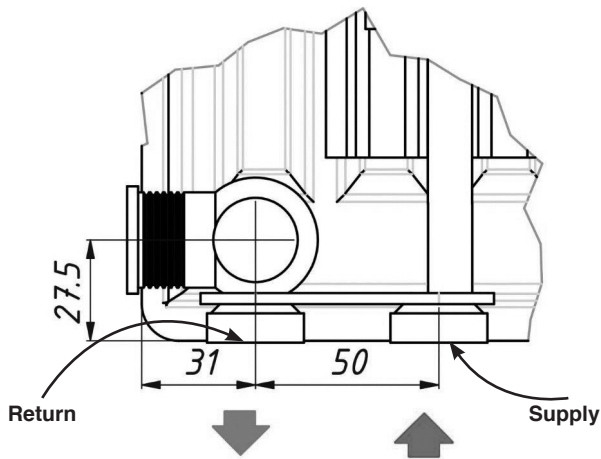

mm	inches
27.5	1-1/16
31	1-1/4
50	1-15/16

Section 4: Bracket Installation Instructions

Type 11 – L Bracket Installation

Step 1: L Brackets can be installed using the thin or wide width of the wall bracket. Job site preference will dictate which installation will work best.

Units should be installed at least 4" above the floor for proper operation. Measure required distance for bracket installation using the brackets on the back side of the panel radiator as a guide. It is recommended to install the brackets on a stud, if one is not available, wall anchors have been provided.

The brackets are identical, no left or right. The U notches on the top and bottom of the brackets face up (refer to Figure 2 page 2). These notches are where the unit will rest.

Step 2: Insert white plastic anti-vibration locking clip into notch at the top of the wall bracket until it clicks (see Figure 5). Insert the small square plastic U clip into the bottom notch of the wall bracket until it clicks (see Figure 6). See Figure 4 for proper placement of top and bottom clips.

Step 3: Install the wall brackets using the wall anchors (when a stud is not available) and bolts supplied with the unit.

Step 4: Install the panel radiator onto the installed wall bracket. Align the bottom U clip with the bottom bracket on the unit, while also aligning the top locking clip with the top mounting bracket on the unit. Push the unit down onto the bracket until the unit locks into place on the top mounting clip. **LOCKING CLIP MUST LOCK OVER THE TOP OF THE MOUNTING BRACKET TO HOLD THE UNIT SECURELY TO THE WALL** (see Figure 7 for reference only, unit not installed on wall).

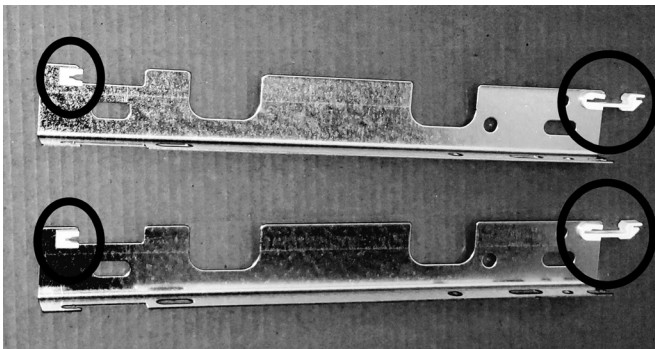

Figure 4 – Locking Clip and U clip Installed

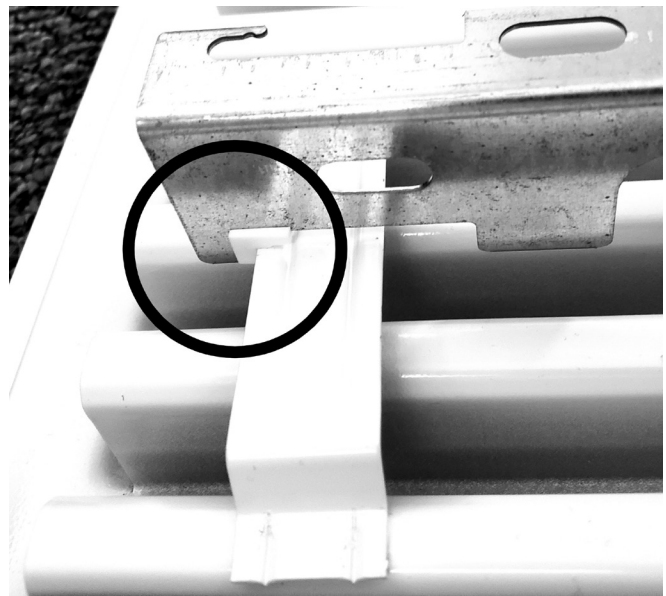

Figure 6 – Bottom U Insert Installed

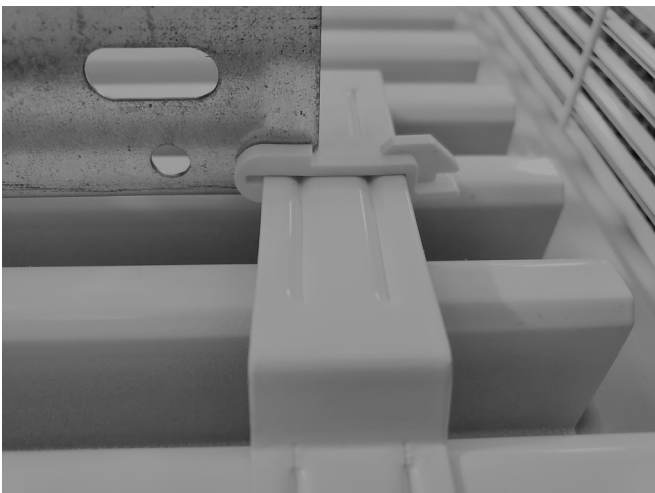

Figure 5 – Top Locking Clip Installed



Figure 7 – Final Assembly for illustration purposes not installed on wall

Types 21, 22 & 33 J Bracket Installation Instructions

Step 1: Wall brackets should be installed on wall joists whenever possible. Mount the brackets on the wall using the bolts and wall anchors provided. The unit should be mounted at least 4" off the floor. The brackets should be installed 4 3/4" in from the edge of the unit on each side. For units over 70" a 3rd bracket is required to be installed. The 3rd bracket should be installed in the center of the unit.

Step 2: Set the unit on the brackets. The bracket height adjustments can be made by pushing in the tab on the plastic slide adjuster (see Figure 8). To adjust the depth of the bracket (adjusts from 1 5/16" to 2 1/8"), loosen the screw at the top of the bracket to slide the hanger forward or back (see Figure 9). Be sure to set the edge of the back panel into one of the notches in the bottom of the bracket to insure the unit is stable (see Figure 11). Tighten the screw at the top of the bracket to secure the unit in place (See Figure 10).

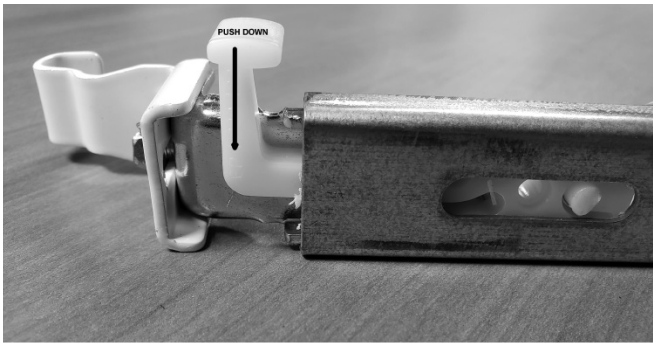

Figure 8 – Height Adjustment



Figure 9 – Depth adjustment

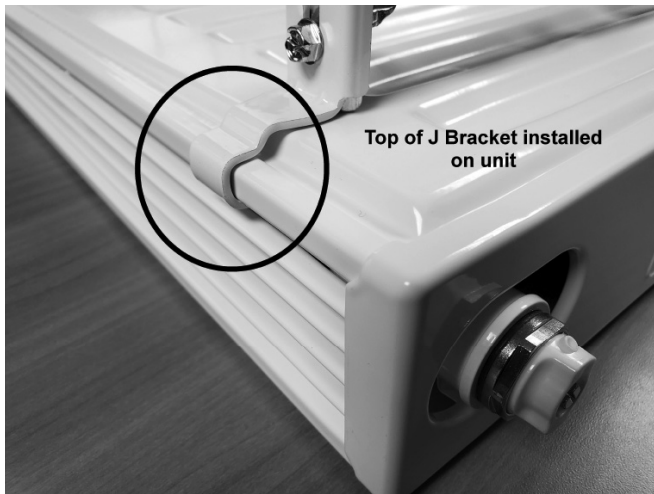

Figure 10 – J Bracket installation



Figure 11 – J Bracket Bottom Notch installation

Section 5: Piping

NOTE: OXYGEN PENETRATION IN THE INSTALLATION NEEDS TO BE AVOIDED IN ORDER TO PREVENT INTERNAL CORROSION OF THE RADIATORS. THESE UNITS MUST BE INSTALLED IN CLOSED LOOP INSTALLATIONS. FAILURE TO DO SO WILL VOID THE WARRANTY.

Check that the unit is firmly in place. Piping to the unit can be done using copper or pex pipe.

Choose a piping arrangement that is suitable for the job. If using 3/4" arrangement, it is highly recommended a 12" allowance of 1/2" piping prior to converting to 3/4". The unit has 6 possible connection points. Two on each side and a bottom connection that can be installed on either the left hand or right hand side as the units are reversible (for all units except the Type 11). Type 11 has right hand connections only. The unit is not reversible. If piping from the bottom, remove the metal covers and the o-rings (see Fig 12). Failure to remove the o-ring will prohibit proper installation of accessories and may cause leaking.

For a bottom piping arrangement, the supply is to the inside of the unit, and the return to the outside (see Fig 13). Should the unit get installed with the incorrect piping arrangement, valves (part # 1016362) are available to reverse the piping with little disruption.

The unit was supplied with 2 blind stops (drain plugs), an air vent, and a thermostatic valve insert and cover.

For bottom piping arrangements, remove the temporary plugs from the left and right hand side lower ports and install the chrome drain plugs. The thermostatic valve and insert must be installed on the same side as the supply and return port located at the bottom of the unit. If piping is on the bottom left hand side, the thermostatic valve and insert must be installed on the top left hand port.

Alternative Piping Arrangements

Below are the recommended alternative piping connections when not piping from the bottom. For alternative piping arrangements not shown, please consult the factory.

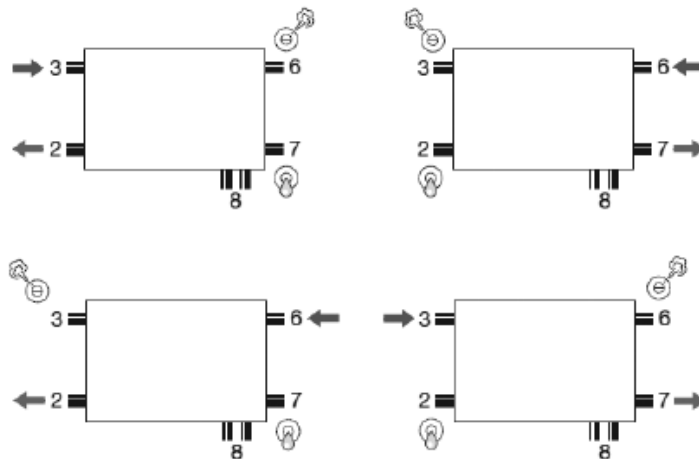

Failure to install correctly will result in noise. Once the insert is installed, a thermostatic head may be installed. If a thermostatic head will not be installed, cover the insert with the white plastic cover supplied with unit. The air vent should be installed on the upper corner opposite the valve insert. See Figure 14 for recommended placement of accessories for bottom piped units.

Once all the connections have been made, the air must be purged from the system. This can be accomplished using the coin air vent that was supplied with the unit.



Figure 12 – O-ring

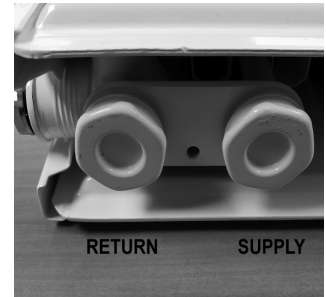





















Figure 13 – Supply / Return connections



Figure 14 – Accessory placement

Section 6: Accessories

Below is a listing of accessories available through Beacon Morris. It is recommended that these accessories be installed with the Beacon Morris Panel Radiator units to insure proper operation.

	Part Number	Description
	551015943 ⁽¹⁾	H valve for isolation and bypass, straight pattern, 3/4" F x 3/4" M
	551015944 ⁽¹⁾	H valve for isolation and bypass, angle pattern, 3/4" F x 3/4" M
	551016362 ⁽¹⁾	Reverse connection H valve, straight pattern, 3/4" F x 3/4" M
	551016462 ⁽¹⁾	Reverse connection H valve, angle pattern, 3/4" F x 3/4" M
	551016844	Compression fitting, set of 2, for 1/2" copper
	551646849	Compression fitting, set of 2, for 3/8" PEX/PEX-AI-PEX
	551646850	Compression fitting, set of 2, for 1/2" PEX/PEX-AI-PEX
	551646851	Compression fitting, set of 2, for 5/8" PEX/PEX-AI-PEX
	551013066	"Vindo TH" non-electric thermostat - Control range locked or limited. 45-82°F
	551011365	"Uni-XH" non-electric thermostat - Control range locked or limited. 45-82°F Mark set valve with memo disk.
	551011410*	"Uni LHB" non-electric thermostat with vandal resistant design Special tool needed to change settings (must order Setting Tool #551011497).
	551011497*	Setting Tool for LHB (#551011410) Thermostat
	551012565	Manual valve handle
	551016674	Rosette cover for pipe entry
	551011450 (special order)	Right angle adapter M30 x 1.5 (special order not stocked)
	551091082	Angle radiator balancing and shut off valve 1/2" NPT - Return Outlet**
	551091182	Straight radiator balancing and shut off valve 1/2" NPT - Return Outlet**
	551889004	Angle radiator valve 1/2" NPT - Supply Inlet**
	551889104	Straight radiator valve 1/2" NPT - Supply Inlet**
	551889204	Reverse angle radiator valve 1/2" NPT
	513919020306	Touch up paint

*Must order both parts. Setting Tool must be ordered as a separate line item to be included.

**Use when piping onsite tapings.

(1) Proper compression fitting must be ordered to connect to H valve.

Thermostatic Valve Settings

The thermostats purchased through Beacon Morris have multiple settings. Refer to the chart below for set points in relation to the number on the valve. The snowflake setting is a low flow / non-freeze setting. This will allow a small amount of water flow to prevent the unit from freezing. If the thermostat is set at 0, no water will flow and the unit will be off. Refer to Figure 16 for the temperature ratings.



"Uni-LH" non-electric thermostat
Part # 1011465 shown

Code	Temperature
0	OFF
1	54°F
2	61°F
3	68°F
4	75°F
5	80°F
	Non-freeze/ Low flow

Figure 15 – Tstat Temperature Ratings

Section 7: Cleaning the Unit

The unit may be cleaned using a vacuum or long handled brush.

Never use abrasive cleaners or cleaning products with chemicals as this may compromise the integrity of the finish. The outside of the units can be cleaned with a non-abrasive cloth or sponge and soap. Thoroughly dry the unit with a soft cloth.



Beacon Morris

260 NORTH ELM STREET, WESTFIELD, MASSACHUSETTS 01085
7555 TRANMERE DRIVE, MISSISSAUGA, ONTARIO L5S 1L4 CANADA