

# Model 6KK61

## Air-Cooled Portable Air Conditioner

### Submittal Data



SD-6KK61-3

#### STANDARD FEATURES

- 61,000 Btu Cooling Capacity
- Spot-Cool / Room-Cool Thermostat Settings
- Internally Insulated with Fiberglass Insulation
- Separate Direct Drive Fan Motors
- R410A Refrigerant
- Digital Control Panel
- Condensate Pump with Overflow Protection
- 230V/1 Phase
- Directional Nozzles (3)
- Heavy Duty Twin Wheel Casters for Portability
- Self-Diagnostic System
- Off-Timer
- Washable Filters
- 20" Hot Air Exhaust Flange



#### SAFETY DEVICES

- Compressor Overload Protection
- Anti-freezing Thermistor
- Drain Pump Failure Protection
- Automatic Restart (Power Interruption)
- Compressor Time Delay Program
- High Pressure Switch

#### SPECIFICATIONS

Model Number	6KK61
Cooling Capacity	61,000 Btu/hr
Cooling Test Conditions	95°F
Voltage/Phase/Hz	230/1/60
Amperage	32
Fuse Size	40 Amps*
LCDI Plug Configuratio	NEMA 6-50P
Power Cord Length	6'
Refrigerant Type	R410A
Dimensions	60"H x 29"W x 51.5"D
Net Weight	661 Lbs
Shipping Weight	694 Lbs
Condensate Tank Capacity	Condensate Pump Included

\*Time delay fuses and circuit breakers are recommended

#### ADDITIONAL SPECIFICATIONS

Ambient Temperature Range	64 - 113°F
Setting Temperature (Room Cool)	64 - 86°F
Setting Temperature (Spot Cool)	32 - 86°F
Application Area Ft <sup>2</sup> (Room Cool Mode)	1700
Refrigerant Type / Ounces	R410A / 112
Design Pressure High/Low	465 / 250 PSIG
Indoor Air Flow High/Low	1700 CFM
Hot Air Duct Diameter	20"
Maximum Exhaust Duct Length	100'
Condenser Air Flow	3600 CFM
FLA	32 Amps
Max Duct Length: Cold Air Supply	60 ft
Max Duct Length: Hot Air Discharge	60 ft
Duct Connection Hot Air Discharge	20 in
Drain Type	Auto pump
Sound level (dBA)	75



260 North Elm St.  
Westfield, MA 0108  
Phone: 413-564-5520  
Fax: 413-564-5815  
www.Koldwave.com

Project: \_\_\_\_\_ Date: \_\_\_\_\_

Location: \_\_\_\_\_

Customer: \_\_\_\_\_

Engineer: \_\_\_\_\_

Submitted By: \_\_\_\_\_

For:  Reference  Approval  Construction

Unit Designation: \_\_\_\_\_

Schedule Number: \_\_\_\_\_

# Model 6KK61-Submittal Data

## CONTROL PANEL

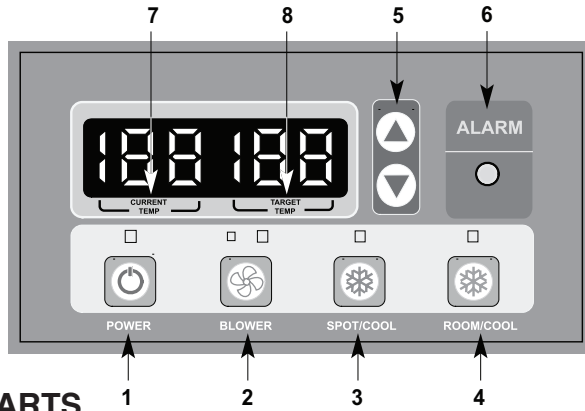

Control Panel Key Buttons:

1. Power
2. Blower
3. Spot/Cool
4. Room/Cool
5. Set Temperature
6. Alarm
7. Current Temperature
8. Target Temperature

## COMPONENT PARTS

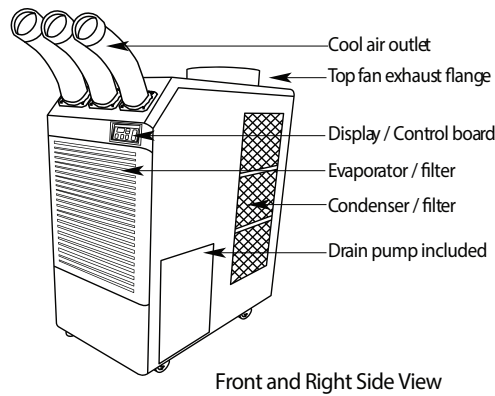

Front and Right Side View

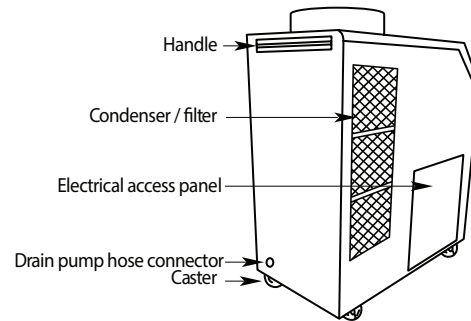

Back and Left Side View

## DIMENSIONS (In Inches)

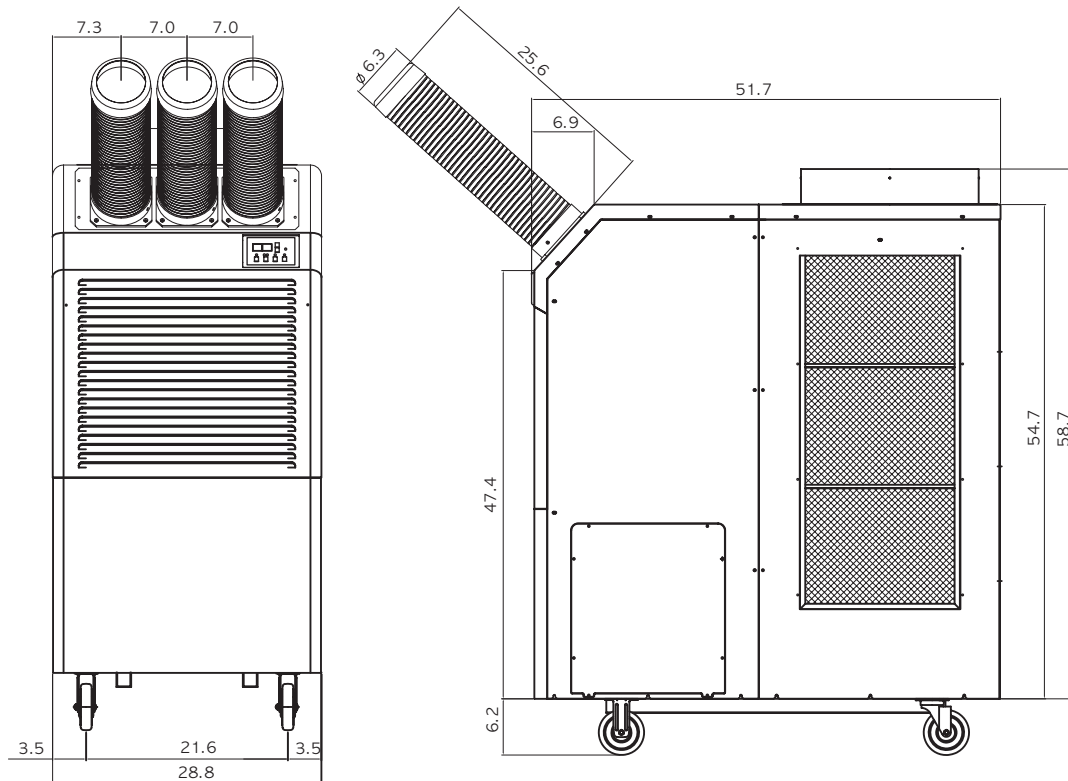

**ASSEMBLY**

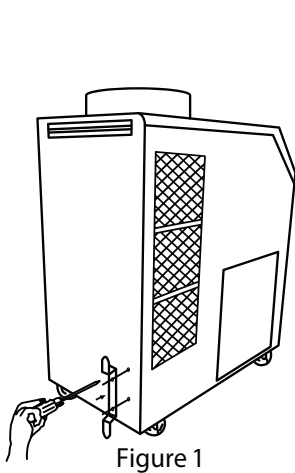

Figure 1

**POWER CORD HOLDER**

1. Take out the cord holder from the accessory box.
2. Place the cord holder on the back side of air conditioner.
3. Use screws (enclosed inside of accessory box with cord holder) to install the cord holder on the air conditioner as shown in Figure 1.

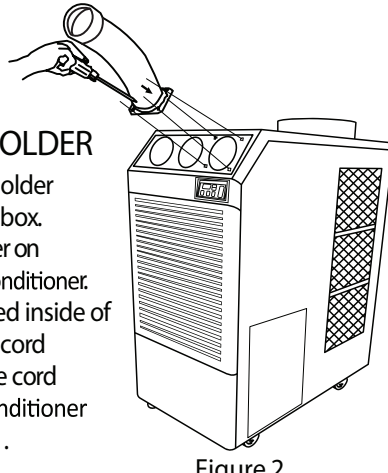

Figure 2

**DISCHARGE DUCTS /SUPPLY AIR DUCT**

1. Remove cool air outlet hose(s) from carton.
2. Place the cool air outlet hose(s) on the front top of air conditioner.
3. Use screws (enclosed inside of box with cool air outlet hose(s)) to install the cool air outlet hose(s) on the air conditioner as shown in Figure 2.

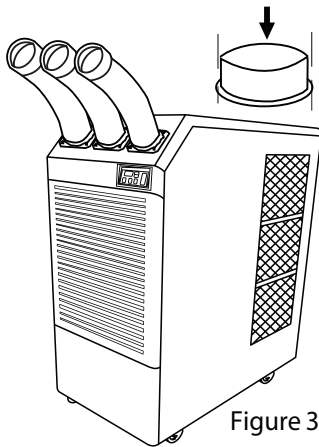

Figure 3

**TOP FAN EXHAUST FLANGE**

1. Remove the topfan exhaust flange from carton.
2. Place the top fan exhaust flange on the top of air conditioner.
3. Use screws (enclosed inside of box with the top fan exhaust flange) to install the top fan exhaust flange on air conditioner as shown in Figure 3.

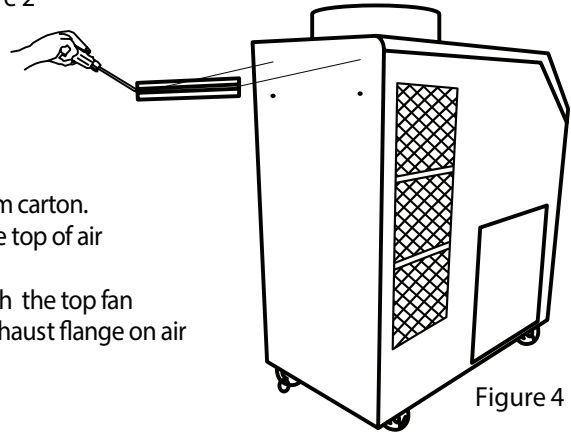

Figure 4

**HANDLE**

1. Remove a handle from carton.
2. Place the handle on upper side of rear panel.
3. Use screws (enclosed inside of box with a handle) to install the handle as shown in Figure 4.

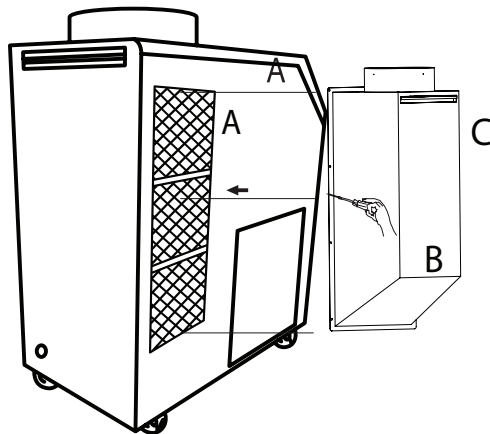

Figure 5

**CONDENSER PLENUM (Optional)**

A condenser plenum can be purchased separately. condenser plenum fits over the condenser to duct condenser air to the unit to improve cooling efficiency

1. Remove the Filter("A")
2. Check the Filter("C") is inserted properly in condenser plenum("B")
3. Install "B" which contains "C" by using driver with enclosed bolts(6EA) as Figure 5.

## Model 6KK61-Submittal Data



### Accessory Parts

Part Name	Part Number
Condenser plenum/return air adapter	SA076-4017
Remote controller (26 ft with line)	SA076-4006
16 FT Temperature sensor	SA076-4007
Long cool air duct assembly (D6", L40")	SA076-4019
Condenser return/discharge kit	SA076-3655
Replacement washable filter, evaporator	KWPCFLT-04E
Replacement washable filter, condenser	KWPCFLT-04C