

# RBI®

RELIABLE. BOLD. INNOVATIVE.



# HEATNET® 3.0

 **FLEXCORE®**  
SYMMETRICAL FIRETUBE

**Gas-Fired Direct Vent  
Stainless Steel Boilers  
CK-Series – CK850-CK9000**

## Control Manual Control Adjustment and Operation Instructions

This instruction manual applies only to  
RBI firmware version 3.x on version 3.x  
control boards.

Also read and follow:

**FlexCore CK-Series Gas Boiler  
Installation and Operating  
Instruction Manual**



**WARNING** This manual is intended only for use by a qualified heating installer/technician. Read and follow this manual, all supplements and related instructional information provided with the boiler. Install, start and service the boiler only in the sequence and methods given in these instructions. Failure to do so can result in severe personal injury, death or substantial property damage.

**WARNING** **Do not use the boiler during construction.** Construction dust and particulate, particularly drywall dust, will cause contamination of the burner, resulting in possible severe personal injury, death or substantial property damage. The boiler can only be operated with a dust-free air supply. Follow the instruction manual procedures to duct air to the boiler air intake. If the boiler has been contaminated by operation with contaminated air, follow the instruction manual guidelines to clean, repair or replace the boiler if necessary.

**CAUTION** Affix these instructions near to the boiler. Instruct the building owner to retain the instructions for future use by a qualified service technician, and to follow all guidelines in the User's Information Manual.

Information contained in this publication regarding device applications and the like is provided only for your convenience and may be superseded by updates. It is your responsibility to ensure that your application meets with your specifications.

RBI MAKES NO REPRESENTATIONS OR WARRANTIES OF ANY KIND WHETHER EXPRESS OR IMPLIED, WRITTEN OR ORAL, STATUTORY OR OTHERWISE, RELATED TO THE INFORMATION, INCLUDING BUT NOT LIMITED TO ITS CONDITION, QUALITY, PERFORMANCE, MERCHANTABILITY OR FITNESS FOR PURPOSE.

<http://www.rbiwaterheaters.com/>

The RBI name and logo, Mestek name and logo, **FlexCore CK - Series**, HeatNet, and H-Net name and logo are registered trademarks of Mestek, Incorporated in the U.S.A. and other countries.

BACnet is a registered trademark of ASHRAE. LonWorks is a registered trademark of Echelon Corporation. All trademarks mentioned herein are property of their respective companies.

© 2012, Mestek Technology Incorporated, Printed in the U.S.A., All Rights Reserved.

# Table of Contents

<b>Table of Contents</b> .....	<b>3</b>
<b>Introduction</b> .....	<b>6</b>
THE FLEXCORE CK-SERIES V3 HEATNET CONTROL .....	6
<b>Features &amp; Specifications</b> .....	<b>8</b>
STANDARD FEATURES OVERVIEW .....	8
<b>Specifications</b> .....	<b>10</b>
<b>Components &amp; Accessories</b> .....	<b>11</b>
PART NUMBER .....	11
<b>Setup &amp; Operation</b> .....	<b>12</b>
BASIC MULTI BOILER SYSTEM OPERATION .....	12
MIXED BOILER TYPES USING PRIORITY SETS.....	13
MIXED BOILER SYSTEM OPERATION .....	14
START/STOP PRIORITY CONDITIONS .....	16
SELECTING MIXED BOILERS.....	17
MIXED SYSTEM TYPE 1: HIGH SYSTEM TURNDOWN.....	17
MIXED SYSTEM TYPE 2: CONDENSING/NON-CONDENSING.....	20
<b>Heating Control Methods</b> .....	<b>24</b>
HEATING METHOD 1 .....	24
HEATING METHOD 2 .....	24
HEATING METHOD 3 .....	24
HEATING METHOD 4 .....	24
HEATING METHOD 5 .....	24
OPERATING LIMIT .....	24
INPUT PRIORITIES .....	25
HEATING METHOD 1 HEAT DEMAND.....	25
HEATING METHOD 2 STAGE CONTROL T1-T2 .....	26
HEATING METHOD 3 4-20 mA CONTROL .....	26
HEATING METHOD 4 AA INPUT.....	27
HEATING METHOD 5 MODBUS COMMUNICATIONS .....	27
<b>Domestic Hot Water Methods</b> .....	<b>28</b>
DHW METHOD 1: DHW HEATING ONLY USING A DHW MASTER AND MEMBER BOILER(S) EMPLOYING H-NET.....	29
DHW METHOD 2: FAILSAFE COMBINATION DHW AND SPACE HEATING WITH A MASTER BOILER AND MEMBER BOILERS UTILIZING VALVES (MASTER TYPE: COMBINATION).....	33
DHW METHOD 2: FAILSAFE COMBINATION DHW AND SPACE HEATING WITH A MASTER BOILER AND MEMBER BOILERS UTILIZING PUMPS (MASTER TYPE: COMBINATION) .....	35
DHW METHOD 3: DHW HEATING ONLY, USING A HEADER SENSOR INPUT.....	40
DHW METHOD 4A: SPACE HEATING WITH DHW OVERRIDE OF SETPOINT ON MASTER, USING AN AQUASTAT .....	43
DHW METHOD 4B: SPACE HEATING WITH DHW OVERRIDE OF SETPOINT ON MASTER, USING A DHW 10K TANK SENSOR .....	46
DHW METHOD 5A: LOCAL DHW TANK HEATING USING A 10K TANK SENSOR. ....	49
DHW METHOD 5B: LOCAL DHW TANK HEATING USING A THERMOSTAT & HYBRID SENSOR. ....	53
DHW METHOD 6: DHW USING DIRECT CONTROL .....	55

DHW MAXIMUM RUNTIME .....	55
BASE LOADING, RELAY CONTROL .....	56
<b>Using the 4-20 mA input (OPTIONAL).....</b>	<b>59</b>
SETPOINT PRIORITIES.....	60
<b>Circulator Pump Options .....</b>	<b>60</b>
<b>Local Pump Options.....</b>	<b>62</b>
<b>Combustion Air Damper .....</b>	<b>63</b>
<b>Outdoor Reset.....</b>	<b>63</b>
<b>Sensors .....</b>	<b>64</b>
<b>Stack Temperature .....</b>	<b>64</b>
<b>Local Flow Sensor .....</b>	<b>64</b>
<b>Security .....</b>	<b>65</b>
<b>Save/Restore Configuration Settings.....</b>	<b>65</b>
<b>USB Features .....</b>	<b>65</b>
<b>Diagnostics .....</b>	<b>66</b>
<b>Blower Protection.....</b>	<b>66</b>
<b>Communications .....</b>	<b>67</b>
<b>Failsafe Modes.....</b>	<b>67</b>
FAILSAFE REQUIREMENTS .....	67
<b>Limited Flow Boiler Control Options.....</b>	<b>68</b>
<b>FlexCore Multi Heat Exchangers .....</b>	<b>70</b>
FLEXCORE CONFIGURATION PLUGS .....	71
COLOR DISPLAY WIRING .....	71
(3) HEAT EXCHANGER WIRING .....	72
<b>HeatNet Online.....</b>	<b>73</b>
<b>Wiring Connections.....</b>	<b>74</b>
<b>Home Screen Navigation .....</b>	<b>86</b>
<b>Home Screen .....</b>	<b>87</b>
<b>Home Screen Messages.....</b>	<b>88</b>
HEATING MODE MESSAGES.....	88
SETPOINT SOURCE MESSAGES.....	89
GENERAL MESSAGES .....	89
<b>Calibration.....</b>	<b>96</b>
CALIBRATION WITH MULTIPLE HEAT EXCHANGERS.....	97
<b>Log Entry.....</b>	<b>98</b>
<b>Control Settings Menu .....</b>	<b>99</b>



**Control Settings Menu — Page 1 ..... 100**

**Control Settings Menu — Page 2 ..... 108**

**Control Settings Menu — Page 3 ..... 116**

**Control Settings Menu — Page 4 ..... 118**

**MODBUS Communications ..... 119**

**Worksheet..... 130**

**Type II Thermistor Resistance/Temperature Table..... 135**

# Introduction

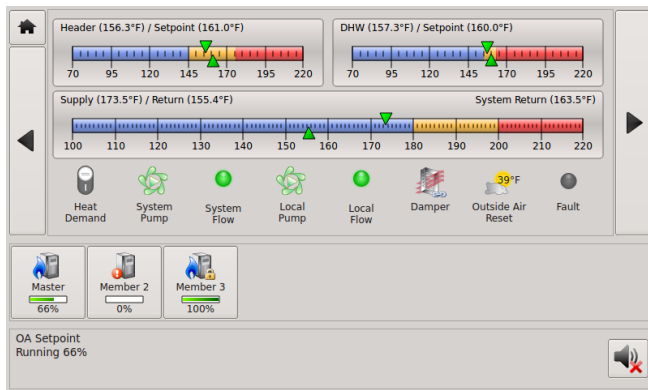
## The FlexCore CK-Series V3 HeatNet Control

The FlexCore CK -Series boiler control is designed to provide the FlexCore CK -Series of boilers with an integrated boiler management system on every boiler. Designed for the Air-Fuel coupled FlexCore CK -Series boilers, the FlexCore CK -Series HeatNet control provides for optimized heating efficiency without the need for a “wall mount control”. Since the FlexCore CK -Series modular control method is based on digital communications, analog control signals are not required. Although the use of analog control signals is still supported (4-20 mA control loops and 0-10vdc control voltages), a higher level of control precision, repeatability, and feedback is gained with digital communications control.

With the FlexCore CK -Series, optimized heating efficiency is accomplished by setting the Modulation Maximum (Mod-Max) setting to exploit the inverse efficiency curve. This value can be adjusted so that as each boiler is added, it operates at its maximum turndown. This allows the maximum number of boilers to operate at their lowest inputs, until all boilers are firing. Once all boilers are firing, full range modulation control is allowed. An outdoor reset function is also provided to assist in the optimized heating efficiency of the FlexCore CK -Series boilers.

The FlexCore CK -Series boiler with the FlexCore CK -Series H-Net control, can be operated in multiple ways:

1. As a stand-alone boiler.
2. A boiler in a Boiler Network using the HeatNet® (H-Net®) protocol.
3. A member boiler to a boiler management system with multiple input control methods.



Home Screen

The primary purpose of the control is to maintain the boiler water temperature at the supply or the header sensor using a

target setpoint. This function is displayed in the Home Screen. While performing this task, the control also monitors dedicated external limits in a limit string and provides an orderly shutdown and fault indication in the event of a tripped limit. The monitored limits include a HIGH LIMIT AQUASTAT, LOW WATER CUTOFF, GAS PRESSURE, FLOW, IGNITION CONTROL fault, GAS VALVE alarm, VARIABLE FREQUENCY DRIVE alarm, and other optional or user selectable limits.

**NOTICE** The HIGH LIMIT circuit is independent of the control and shuts down the ignition control and the boiler if the control board or other component of the boiler was to malfunction. The control will continue to function and report the fault, but its ability to control the boiler will end.

Each FlexCore CK-Series boiler employing this control can function as either a Master or a member. This allows one boiler (Master) to be in control of target temperature. The other boilers (Members) only respond to the commands issued by the Master. If using an external control, all boilers can be setup as members. The following will define the roles of Master and member.

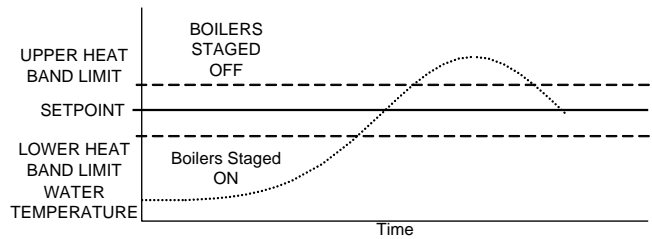
### Master

A boiler becomes a Master when a temperature sensor is connected to the J10 “SYSTEM HEADER” terminals. The sensor is auto-detected.

The Master senses and controls the common system header/loop water temperature using a system setpoint. It uses any boilers it finds (over the H-Net communications cable) to accomplish this. It can also monitor the Outside Air (OA) temperature to provide outdoor reset functionality. **Only one Master is allowed in a system.**

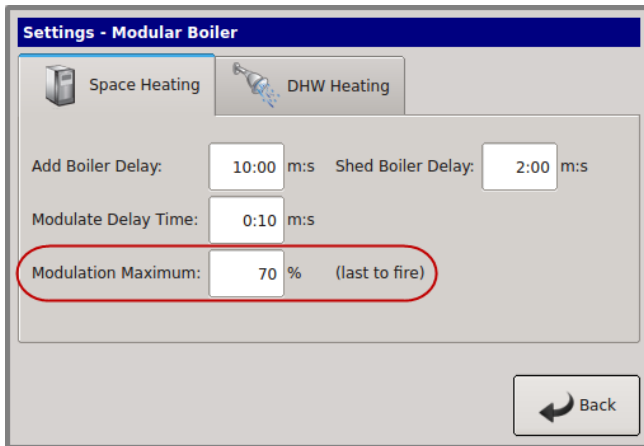
When operating as a Master, the boiler provides a control method using a PID algorithm to regulate water temperature. This algorithm allows for a single boiler (Master), or multiple (Master + Member) boilers.

Figure 1 Heat band



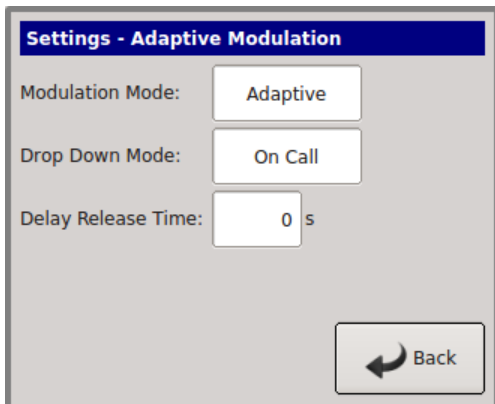
The control algorithm is based upon a Heat Band, at the center of which is the setpoint. While below the Heat Band, boilers are staged on and modulated up until the Heat Band is entered. Once in the Heat Band, modulation is used to maintain setpoint. Boilers are shut down only when the top

of the Heat Band is breached. Timers are also used to prevent short cycling.



While staging the boilers on, a modulation clamp is used to hold the boilers at a lower fire rate until the last boiler is fired. Once the last boiler fires the modulation clamp is removed, and all boilers are allowed to fire above this clamped percentage up to 100%. This “boiler efficiency” clamp is defaulted to 70% and thus limits all of the boilers individual outputs to 70% until the last boiler fires. All running boilers modulate up and down together, always at the same modulation rate. As a general rule, this percentage should be no lower than twice the minimum turndown to minimize short cycling.

When additional boilers are needed to achieve setpoint in the system, the Master boiler employs an ADAPTIVE MODULATION algorithm to prevent over firing of the system. The Master communicates over the H-Net to view the exact status of each Member boiler. When a new boiler is added, the Master boiler adjusts the system modulation rate lower to compensate for the BTUs that will be introduced by the newly added boiler. This adjustment occurs when the newly added Member boiler enters its ON CALL state (default setting). This can be changed to PILOT when the new boiler is called using the menu:



**ADAPTIVE MOD: DROP DOWN.** Once the Main Valve (on the newly added boiler) is opened, and the **DELAY**

**RELEASE** timer equals zero, the PID algorithm is allowed to control the system modulation. **Setting** the DELAY RELEASE timer will allow some “soak” time of the newly added boiler before releasing modulation control to the PID.

**NOTICE** The ADAPTIVE MOD menus are disabled on a Member boiler, but are still visible.

### Member

If a “SYS/DHW HEADER” sensor is **not** connected to J10, a boiler always defaults to the role of Member.

The Member boiler can operate as part of a multi-boiler system or as a stand-alone unit.

In a multi-boiler system the Member typically receives its command signals from a designated Master-boiler. It is also capable of receiving inputs from an external control system. The boiler responds to these signals, to start/stop the burner, and/or to modulate the firing rate. The outlet water temperature is also monitored. If the outlet temperature approaches the operating limit temperature setpoint (adjustable), the boilers firing rate is limited and its modulation value is reduced to minimize short-cycling. If the operating limit is exceeded, or if an interlock trips, the boiler is shut down. When connected with a network cable, in a Master/Member role, the Members' status is interrogated by the Master boiler.

In a stand-alone installation the Member typically receives its command signals internally and operates based upon the outlet water temperature input and the established settings in the menu (Local Set-point) to start/stop the burner, and/or to modulate the firing rate. If the operating limit is exceeded, or if an interlock trips, the boiler is shut down. As in a multi-boiler system, a stand-alone Member boiler is also capable of receiving inputs from an external control system.

When using the H-Net network cable in a Master/Member system, the system setpoint is sent from the Master as a digital signal, along with the modulation value to control firing rate. It also receives its command to start or stop over the H-Net cable. Also, the SYSTEM CLOCK only needs to be set on the MASTER. The Master will then set the time on all member boilers.

If not using the H-Net protocol (cable), an external control can send a 4-20 mA signal along with a 4-20 mA enable signal to control the firing rate or setpoint. The boiler may also be treated as a 2-stage boiler or an ON-OFF boiler using the dedicated T-inputs.

## Features & Specifications

### Hardware Version 3.x Control

#### Features

#### (Identified by circuit board color: BLACK)

1. Support for (2) Circulator pumps. Two rotation modes are provided: Based on system runtime or system pump runtime hours. Pump failure switchover/retry mode.
2. Warm weather shutdown, (2) pump jog and local pump jog to keep pumps from seizing.
3. The Modbus, BACnet or LonWorks communications port can be accessed concurrently with the USB port (HeatNet Control Pro). The BACnet, LonWorks, or Modbus connections do not need to be disabled to use the USB ports.
4. The DHW pump and the Local Pump relay connections now provide a normally closed contact. This allows for the use of a power open/power close valve.
5. Support for 5ma 0-10v control signals using third party controls.
6. Support for (2) display types: Vacuum Florescent and Color LCD using the same 20 pin ribbon cable.
7. System Return sensor input.
8. Enhanced bootloader and firmware storage. One firmware storage location for user updates. One firmware program that always remains resident so that a factory program can be restored. Primary loading is with a flashdrive.
9. Support for High Efficiency Ametek blowers.
10. 32 bit Microcontroller operating @ 64 MHz with 5-stage pipeline, and prefetch cache.
11. (3) Stage control relay outputs for TBD applications.
12. Backwards compatible with existing HeatNet versions 1.x and 2.x controls and applications.
13. Support for 135 Ohm control actuators.
14. 1k Platinum Stack sensor
15. Flow meter input or BMS GPM input/control
16. On-board HeatNet Online network module.
17. Dual PID controls. One for space heating and one for DHW heating. Allows for simultaneous DHW/Space heating.

### Standard Features Overview

1. Five levels of external control inputs, including modulation and staging that provide application flexibility.
2. Digital Communications Control (analog 4-20 mA and 0-10vdc control supported, but not required).
  - a. Boiler to Boiler : HeatNet (H-Net)
  - b. **Building Management System (MODBUS, Optional BACnet or LonWorks) to Boiler**
3. Distributed control using the HeatNet (H-Net) protocol for up to 16 boilers. Eliminates the need for “wall mounted” controls.
4. Analog Control 4-20 mA and 0-10vdc (5mA minimum current) signals supported.
5. System/Boiler operating status text display
6. Interlock, Event, and System logging with a time stamp.
7. Advanced PID algorithm optimized for the FlexCore CK -Series boilers.
8. (4) Dedicated temperature sensor inputs for: Outside Air Temperature, Supply (Boiler Outlet) Temperature, Return (Boiler Inlet) Temperature, and Header (Common System Supply) Temperature.
9. Automatically detects the optional temperature sensors on power up.
10. Menu driven calibration and setup menus with a bright (Adj.) 4 line Vacuum Fluorescent Display.
11. (8) Dedicated 24vac interlock monitors, and 8 dedicated 120vac system monitors used for diagnostics and providing feedback of faults and system status.
12. Multiple circulator pump control modes.
13. Combustion Air Damper control with proof time, support for a common combustion air damper.
14. USB/RS485 network plug-in to allow firmware updates or custom configurations.
15. Optional BACnet or LonWorks interface.
16. Alarm Relay dry contacts, and Audible Alarm.
17. Runtime hours, and Cycles (based on Main Valve Open).
18. Outdoor Air Reset with programmable setpoint and ratio.
19. Time of Day clock to provide up to (4) night setback temperatures.

20. Failsafe mode when a Building Management System is controlling setpoint. If communications is lost, the boiler/system automatically transfers to local boiler setpoint control.
21. Rotation Methods (Lead-Lag): True Rotation (based on boiler runtime) is default. First On First Off (FOFO), Last On First Off (LOFO) and MIXED are optional.
22. Programmable password protection to secure the programmable settings.
23. Remote 4-20 mA setpoint control using a mapped setpoint range to the 4-20 mA control signal.
24. Freeze Protection allowing automatic starting of boiler(s) using (2) Failsafe modes.
25. Adaptive Modulation. When additional boilers are called, the Master adjusts all boilers fire rates to compensate.
26. Mixed boiler types in a system.
27. Support for Domestic Hot Water (DHW) using a 10k Sensor or a dry contact input from a tank thermostat.
28. Domestic Hot Water relay for use with a pump or valve.
29. On-board power and socket for Processor BACnet/LonWorks module.
30. HI/LO relay control option from connector J4
31. Resettable Fused interlock power circuit.
32. Additional terminal connector for H-Net shielded cable.
33. Backwards compatible to Version 1.x hardware.
34. Communications board integrated with the main board from version 1.x control.
35. Base Loading of (1) boiler.
36. Delayed Blower Power staging. Used to minimize inrush currents by powering the blower 7 seconds after main power.
37. Domestic Hot Water time out for maximum DHW runtime.
38. Added the Local Minibus for inter-boiler communication. Primarily FlexCore series.

## **FlexCore Multi Heat Exchangers**

1. Multiple HeatNet controls serving each heat exchanger.
2. Direct wiring for Heat Exchanger - HeatNet to HeatNet handshaking.
3. New Minibus for digital communication between internal HeatNet boards.
4. Personality profiles for each FlexCore model.

---

## Specifications

Control	Microprocessor based PID modulating control ( <b>NOT a safety limit</b> )
Environment	-40 °F to 140 °F, <90% RH non-condensing
Input Power	24 VAC, 500 ma
Relays	System Pump, Damper, Circulator, Alarm, DHW Pump (v2.x), 8A 250 VAC resistive K8 on J4.2 &.6 for Base Loading version 2.x Control
AC Interlocks	24 VAC – 120 VAC input
Control Inputs	AA, Heat Demand, 4-20 mA Enable, OA override, T1-T2 (dry contact inputs) 4-20 mA, 0-10 VDC
Dimensions	9” wide: 6” high: 2” deep
Temperature Sensors	NTC thermistor, 10K @ 77 °F, 335.67K @ -40 °F, 185 @ 150 °F ,+/- 1 °F
USB	1.0
RS485 MODBUS	Modbus RTU
Boiler-to-Boiler	HeatNet (H-Net)
Heat Exchanger to Heat Exchanger	HeatNet (Minibus)
Network	Optional LonWorks, BACnet available bridge to MODBUS port

---

## Components & Accessories

### Part Number

40-0092	FlexCore CK -Series Control Board Version 3.x Full version (Manager)
40-0093	FlexCore CK -Series Control Board Version 3.x Lite Version (Subordinate)
40-0090	Color Touch Panel Display (CK1500 – CK9000)
40-0079-001	Subordinate 2 Configuration Plug (220 Ohm)
40-0079-002	Subordinate 3 Configuration Plug (470 Ohm)
16-0026	ACI/10K-CP-BP Temperature probe (bullet type, 1x.250 inch)
14-0325	ACI 10k-CP-I-NW Supply, Header, Return Sensors
13-0104	ACI CP-I-2.5” Sensor with well
14-0328	ACI X/(2) CP-PO -4 4” probe with dual sensor
14-0329	ACI X/(2) CP-PO -6 6” probe with dual sensor
14-0319	ACI 10k-CP-O Outside Air Sensor with Housing
82-0403	Installation & Operation Manual
44-0060	RJ45 Communications Cable Assembly, 25 feet
40-0115	Ribbon Cable Assembly (Display Control)
44-0061	USB Cable Assembly, 6ft
Contact Factory	MODBUS to BACnet bridge
Contact Factory	MODBUS to LonWorks bridge
Contact Factory	MODBUS to HeatNet Online bridge

# Setup & Operation

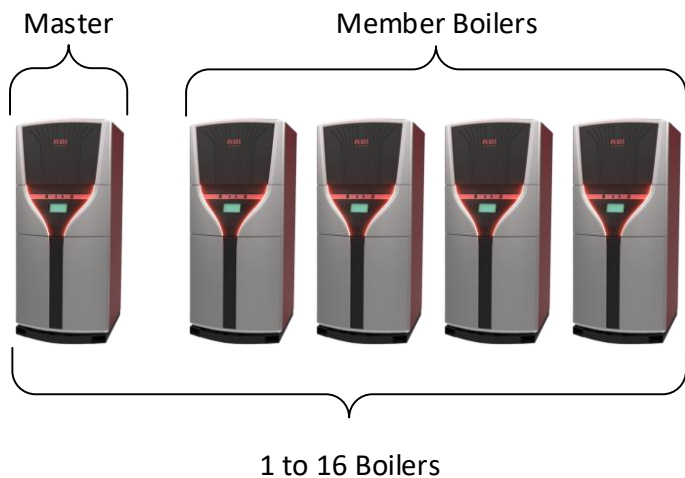
## Basic Multi Boiler System Operation

**NOTICE** For boiler system setup/installations please refer to the *2008 ASHRAE Handbook, CH12* or later revision.

A basic multi boiler system typically uses boilers of the same size and type. With HeatNet, this includes (1) Master and (1-15) Member boilers. The boilers are connected together using an H-Net communications cable effectively creating (1) boiler. This allows the system heating BTUs to be evenly distributed amongst all of the boilers.

The Version 1.6 HeatNet board requires Minibus connections for FlexCore boilers with more than (1) heat exchanger. The Minibus requires a serial data cable between each HeatNet Control board. The first and last Heat Exchanger must have the minibus terminated for the bus to work properly. S1 would be placed in the ON position as indicated below for the front and rear heat exchangers. The jumper, JS1 must always be in the position indicated (closest to S1). It is used for testing.

**Figure 2** Basic multiple boiler system



A basic multi boiler system can be configured using the boiler menus to create custom systems/features. These features are best described in the section: **Default Settings & Menu Item Description**. Along with these menu items are hardware support for many auxiliary functions.

Once the system has been properly setup (all default menu values used and H-Net addresses assigned), the system is enabled by placing the REMOTE/LOCAL switch to the LOCAL position on the Master boiler. All Member boilers must have their respective switches in the REMOTE position. When the Master boiler's Heat Demand input

(LOCAL switch) closes, the system becomes operational and will fire as many boilers as it needs to maintain the header water temperature's setpoint. See the DHW section to fire using two setpoints.

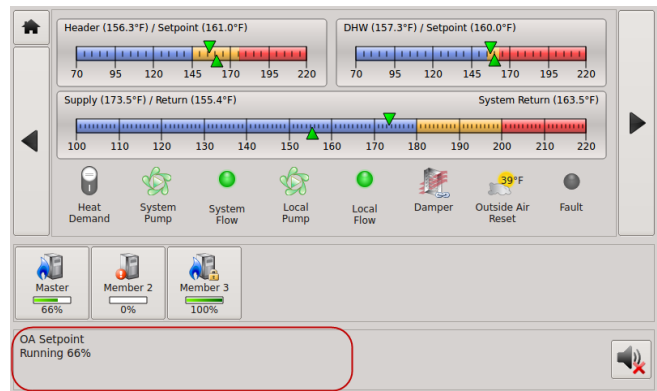
When a boiler is to be fired in a multi boiler system (header water temperature is below the heating band), the Master checks the HeatNet boilers it has available. Then the Master checks if a Lead Boiler is to be used (LEAD BOILER > 0). The Master boiler then looks at which type of firing rotation it has selected: LOFO, FOFO, TRUE (runtime), or MIXED. In our example we will use the TRUE (runtime) rotation since it is the default.

The Master now checks all of the runtimes to determine which boiler has the least runtime based on the MIN RUNTIME setting in SETTINGS: FIRING MODE: The MIN RUNTIME setting is the minimum runtime interval in hours that is used to compare boiler to boiler runtimes.

Once the boiler designated to fire has been determined, the Master sends the command over the H-Net cable to fire that boiler and resets the ADD BOILER delay timer to prepare for the next boiler to fire. If the header water temperature is still below the heating band and the ADD BOILER delay timer has expired to zero, the process is repeated until the header water temperature enters the heating band.

When a boiler receives a command to fire:

**NOTE:** Runtime messages are displayed in the lower left corner of the **Home Screen**. See Section **Messages** for descriptions.



1. The system pump relay is enabled and the H-Net control displays "Waiting for Flow" until the flow-switch closes between J11A, 1 & 2 within the programmed time (10 seconds default).
2. All elements in the interlock string, terminated between J11A and J11B, must be closed before the sequence is allowed to continue.
3. If all interlocks are closed, relay K5 is enabled to command the combustion-air damper open (if used). The H-Net control displays "Waiting for Damper to Open" until the damper end switch closes.
4. Relay K6 is enabled energizing the local pump (if used). The H-Net control commences its Waiting for



Flow” timer (adjustable 10–240 sec.). The flow switch contact is checked on terminals J11B, 5 &6.

5. With all the interlocks closed, the boiler start relay K1 is enabled and energizes terminal 6 on the ignition control. This signal is present on **J5 Boiler Start Operator**. The control now displays “Waiting for Start Sequence”
6. The ignition control begins its cycle and provides an output signal from terminal 4 to the H-Net control **J5 Blower**. The H-Net control responds and provides an output signal to the VFD which sets the blower to the programmed pre-purge speed. If an Ametek blower is used, a soft start speed is applied before the pre-purge speed.
7. After air-flow is established the ignition control waits for the air switch to close. When the air switch closes it provides an input to terminal 7 and pre-purge timing commences. The H-Net display indicates “Pre-Purge”.
8. When purge is complete the ignition control energizes the pilot gas valve from terminal 8, and the spark generator from terminal 10, beginning a 10-second Pilot Flame Establishing Period (PFEP). The H-Net control responds to **J5 Pilot Valve** and provides an output signal to the VFD which sets the blower to the programmed ignition speed. The H-Net display indicates “Pilot”.
9. At the end of the PFEP the spark generator is de-energized. If the pilot flame is detected, by the UV scanner, the ignition control energizes the main gas valve from terminal 9 to **J5 Main Valve**. The H-Net display indicates “Running 0%” (0% indicates PID modulation signal is not being calculated yet).
10. If main-flame is detected the H-Net control holds the burner at the low-fire rate for the MODULATION DELAY time period. After this timer expires, the PID allows the boiler to modulate and places the boiler into the running state.

As boilers are added to the system settings in the **SETTINGS: ADAPTIVE MODULATION MOD: DROP DOWN** menu determines when the modulation rate drops down to compensate for the newly added BTUs. For the drop down to be active, one boiler needs to be running when a new boiler is added (see: *Introduction: The FLEXCORE CK-SERIES H-Net Control: Master*).

If all boilers are firing, the modulation rate is released to go to 100%. If all boilers are not firing, the modulation is limited to the MOD-MAX clamp value. The MOD-MAX clamp is used to keep the boilers running as efficiently as possible. The following *Mixed Boiler System Operation: Selecting Mixed Boilers* section outlines this with examples.

**NOTE:** If the boiler is running as a stand-alone boiler or is direct modulated (including the AA input), the MOD-MAX clamp will also be in effect for the ADD BOILER DELAY time. This is to minimize thermal shock to the boiler.

Once the header water temperature is in the heating band, only the modulation rate is used to achieve the target setpoint. The system will maintain the setpoint until the load demand increases or decreases.

As the load decreases, the header water temperature will start approaching the top of the band. The PID now lowers the modulation rate to the boilers, attempting to keep the temperature within the heating band. If the system is delivering too many BTUs, the water temperature will cross the top of the heating band.

When the header water temperature first exceeds the top of the heating band, the boilers are again checked for the one with the most runtime. The selected boiler will turn off immediately and a shed boiler delay timer will be loaded with the delay time. This time will need to expire before the next boiler will be stopped, but only if the header water temperature remains above the heating band. This timer is used to allow the header water temperature to return back into the band when a boiler is stopped. When a boiler is stopped there is a fixed rate of BTUs (Min Fire) that will be removed (PID discontinuity to modulate from Min Fire to 0 BTUs on a boiler). The timer allows for this loss of BTUs.

This cycle will continue until the call for heat is satisfied or the Warm Weather Shutdown feature is enabled.

## Mixed Boiler Types Using Priority Sets

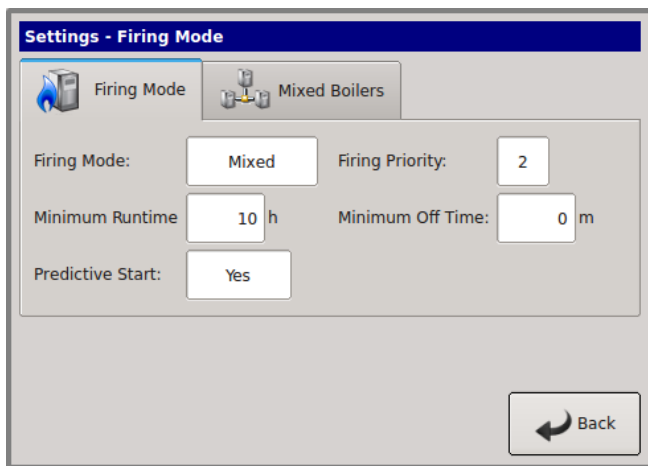
Using the *Basic Multi Boiler System Operation*, a MIXED boiler Priority method may be added to control condensing, non-condensing, base load, or other boiler **SETs** in a system together. These sets compose a system which provides for optimal performance and economy. Having dedicated sets of boilers gives the system engineer a tool to create many different boiler systems.

A boiler set can be constructed by simply setting the firing Priority on each boiler (to be in a set) at the same priority. Setting all (example) condensing boilers to the highest Priority of 1, and then setting all (example) non-condensing boilers to a Priority of 2, will create (2) sets of boilers, one condensing and the other non-condensing. Once this is done, the Priority 1 set of condensing boilers will have a firing order that has a higher Priority and is independent of the other non-condensing set with the lower priority. The boiler set with the highest Priority can then be fired based on a conditional settings menu. The lower Priority set will follow.

## Mixed Boiler System Operation

### Starting Boilers:

When a boiler is to be fired (water temp is below the heating band), the Master checks the HeatNet boilers it has available. The Master boiler then looks at which boilers are returning Priority firing status (set on a boiler in: (SETTINGS: FIRING MODE: FIRING PRIORITY: PRIORITY: 1). If the Start condition for the Priority 1 set is met (SETTINGS: FIRING MODE: MIXED BOILERS *FIRST (example)*), the Master or Member boiler that is configured as PRIORITY 1, with the lowest runtime, will be fired *FIRST (example)*.



As long as the start condition for Priority 1 is met, all boilers in the PRIORITY 1 set will fire based on runtime. Once all boilers in the PRIORITY 1 set have fired, the PRIORITY 2 set of boilers will fire based on runtime.

If the Start condition changes and/or is not met (such as with: OA T or RET temp), the PRIORITY 2 set of boilers will fire first/next based on runtime. This has the effect of flipping the Priority of the sets.

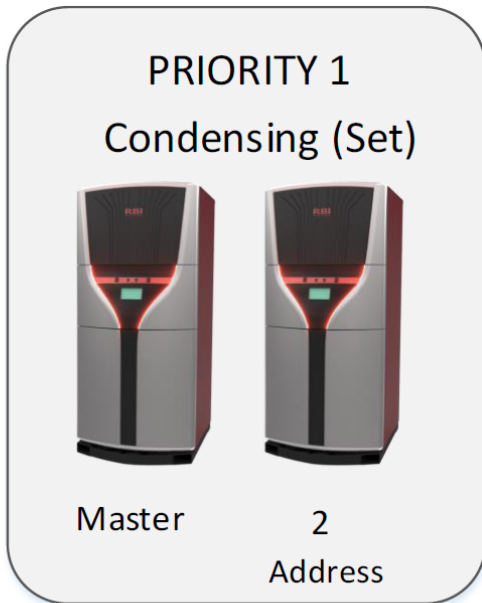
### Stopping Boilers:

When a boiler is to be stopped (water temp is above the heating band), the Master checks the HeatNet boilers it has available. The Master boiler then looks at which boilers are returning Priority firing status (set on a boiler in: (SETTINGS:FIRING MODE: MIXED BOILERS *LAST(example)* If the Stop condition for Priority 1 is met, the Master or Member boiler that are configured as PRIORITY 1 with the highest runtime will be stopped *LAST (example)*. As long as the stop condition and SHED DELAY time are met, all the remaining PRIORITY 1 set of boilers, will stop based on runtime. If the Stop condition changes and/or is not met (such as with: OA T or RET temp), the PRIORITY 2 set of boilers will stop first/next based on their highest runtime.

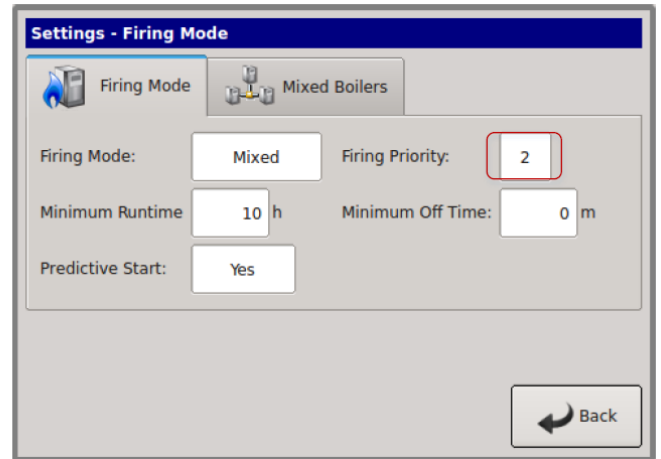
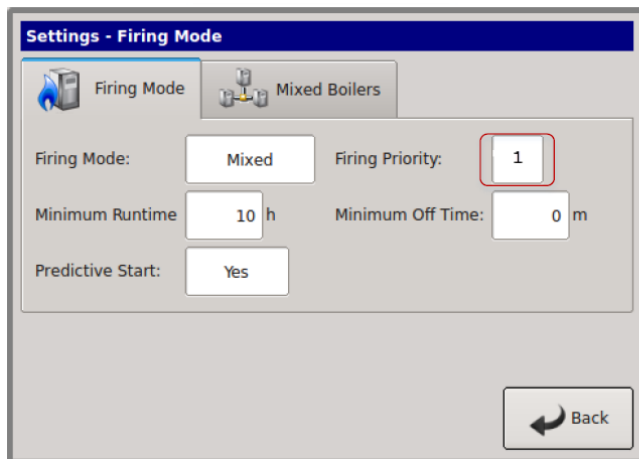
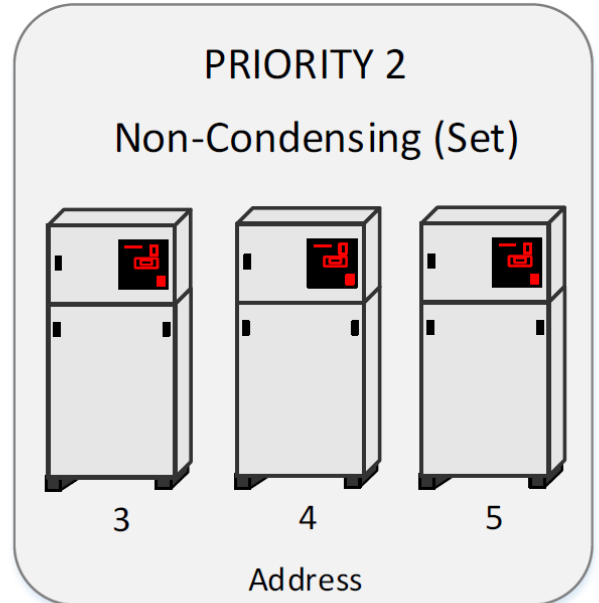
A boiler's firing Priority can be designated as such in: SETTINGS: FIRING MODE: FIRING PRIORITY: PRIORITY menu on each boiler. A Priority of '1' is the highest priority, a '2' the lowest (default is always 2).

**Figure 3** Mixed Boilers: Example: Condensing/Non-Condensing

FIRING MODE (MASTER)  
&  
BOILER TYPE All Boilers in Set

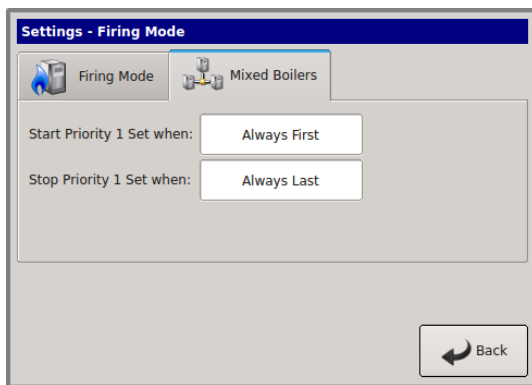


BOILER TYPE  
(All Boilers in Set)



In the example *Mixed Boilers: Condensing/Non-Condensing*, condensing boilers and non-condensing boilers are used, but other combinations may also be used. Another example could use (2) small boilers and set them to Priority 1 and then use (3) larger boilers and set them to Priority 2. Using these Priority settings (with the conditions menu), the small boilers can run first during the shoulder months (Spring and Fall) and the larger boilers can fire last during the colder Winter season (base loading set).

Before the MIXED method can be used, the firing mode on the Master boiler must be set to **MIXED. SETTINGS: FIRING MODE: MIXED**. Pressing the MIXED BOILERS tab will enter the conditions menu. The **START** and **STOP** conditions for starting and stopping the Priority boiler set may be configured here. Temperatures are adjustable.



Once the Mixed Boilers menu has been entered, the firing order and stop order of the Priority 1 boiler set can be selected based on up to (3) conditions in the conditional settings menu. All conditional settings apply to the Priority 1 boiler set. When the conditional settings do not apply to the Priority 1 set, the conditional settings will apply to the Priority 2 boiler set.

**Note:** *If the firmware version for a HeatNet V2 board is at least 3.47 (or a version 3 board), the non-condensing boiler may hold itself off from being added to the HeatNet Master's available to fire list. This would effectively keep the non-condensing boiler from firing in a condensing mode, but as a result, may not satisfy the system setpoint. See: SETTINGS: HEAT EXCHANGER TEMP DISAB:*

## Start/Stop Priority Conditions

The following is an example using mixed condensing and non-condensing boilers:

### FIRE FIRST

Condensing boilers may be configured to **fire first** (set to PRIORITY 1) when:

1. The Return water temperature is below 140F and condensing occurs. (The Master's system return water would need to be used.)
2. The Outside Air Temperature is above a setpoint determined by the system configuration. This setpoint ensures that the more efficient condensing boilers run first during shoulder months (Spring and Fall) when minimal heating is required. Below this setpoint, larger boilers should be brought on first to "base load" the system.
3. Greater efficiency is required.

### STOP FIRST

Condensing boilers may be configured to **stop first** (set to PRIORITY 1) when:

The Return water temperature is above 140F and condensing is minimized, thus leaving the larger lower cost boilers running to carry the load.

1. The Outside Air Temperature is below an adjustable setpoint determined by the system configuration. This setpoint ensures that the larger non-condensing boilers run during the coldest months when maximum heating is required. Above this setpoint smaller condensing boilers should be brought on first to run the system as efficiently as possible.
2. Maximum heating is required

### START PRIORITY 1 SET

**Selections** (always the lowest runtime first):

#### NOTICE

The *condensing boiler set* (Priority 1) has a higher Priority to *fire* when one of these conditions is met. Values are adjustable.

**FIRST:** The condensing boilers (Priority 1) are always started FIRST

**OA T > 15F:** The condensing boilers (Priority 1) are started when the OA temperature is greater than the Mixed Boiler Outdoor Air Temperature setting.

**RET < 140F:** The condensing boilers (Priority 1) are started when the Return water temperature is less than the Mixed Boiler Return temperature setting (This may not be applicable in most configurations since the local return temperature on the Master is used to provide a difference temperature across the heat exchanger. A System Return sensor will be required. However, the return temperature sensor may have been moved on the Master to provide system return temperature on existing installations and is still supported).

### STOP PRIORITY 1 SET

**Selections** (always the highest runtime first):

**NOTICE**

The *condensing boiler set* (Priority 1) has a higher Priority to *stop* when one of these conditions are met. Values are adjustable.

**LAST:** The condensing boilers (Priority 1) are always stopped LAST.

**OA T < 15F:** The condensing boilers (Priority 1) are stopped first when the OA temperature is less than Mixed Boiler Outdoor Air Temperature.

**RET > 140F:** The condensing boilers (Priority 1) are stopped first when the Return water temperature is greater than the Mixed Boiler Return temperature. (This may not be applicable in most configurations since the local return temperature on the Master is used to provide a delta temperature across the heat exchanger). A System Return sensor will be required. However, the return temperature sensor may have been moved on the Master to provide system return temperature on existing installations and is still supported).

### Start/stop settings

Any combination of Start Conditions and Stop Conditions can be used to optimize the mixing of condensing (Priority 1) and non-condensing boilers (Priority 2) for best performance/economy.

The default start setting always starts the condensing boilers (Priority 1 example) first, except for the lead boiler setting. The **lead boiler** will always start first if enabled, unless there is a boiler already running (this includes a Member boiler in LOCAL). The default stop condition setting always stops the condensing boilers (Priority 1) last.

If prolonging the life of the heat exchanger(s) on non-condensing boilers is very important, consider starting the condensing boilers (Fusion-Series) when the return water temperature is below 140F.

**NOTICE**

The return water temperature sensor would need to be moved from the Master's return inlet to the system return. The **EXCHGR DELTA** may need to be adjusted in **SETUP: AUX FUNCTIONS: HEAT EXCHANGER** to prevent the Master from going to ½ input when a high **DELTA T** is reached.

This method would lead to the non-condensing boilers carrying the load when the system temperature stabilizes above 140F, since non-condensing boilers will start first with the Return water temperature is > 140F. The condensing boilers can then be stopped first when the RET water temperature is above the 140F. Remember, any combination of the Start and Stop conditions may be applied for best performance and economy in the system. Also, non-condensing boilers may be set to go offline when a return temperature is too low using the **SETUP: AUX FUNCTIONS: HET EXCHANGER: TEMP DISAB** menu.

Base load boilers can also be mixed in the same way as condensing and non-condensing boilers. The base load boiler(s) can be prioritized in one set (example, Priority 2) and non-base load boilers (Priority 1). The non-base load boilers can then be set to fire first and once they are all firing, the base load boiler would fire.

To minimize the cycling of a large base load boiler, consider using the stop condition. Change it to the OA T < 15F (Outside Air Temperature) condition. This setting may be used to stop the Priority 1 boiler set when the OAT drops below the OA T setpoint, thus leaving the large base loaded boiler on and shutting off the condensing boilers first. This is also true when using the OA T setting to start the Priority 1 boiler set when the OA T is above the start setpoint. To use temperatures as start and stop conditions, the system design temperatures must be known.

## Selecting Mixed Boilers

There are a few factors to consider when choosing which type of boilers to use in a mixed system. These factors need to be considered when boilers are added or shed. When BTUs are introduced into the system by adding boilers, the amount of introduced BTUs should be smooth (linear). If these factors are not considered, discontinuity in BTUs may occur when boilers are added and as a result, short cycling will occur.

1. **Turndown:** This is the ratio of minimum fire rate to maximum fire rate: Example: a 20% minimum modulation = 5:1 turndown (100% mod / 20% mod). A (1) million BTU boiler = 200,000 BTUs minimum in.
2. **MOD MAX CLAMP:** This value determines the maximum modulation % at which the boilers will fire to, until all available boilers are firing.
3. **Total System BTUs.**
4. **Desired Effective Turndown.** This is the lowest firing rate of the system relative to the maximum firing rate of the system. The larger the value, the lower the BTUs that can be delivered to a light load.
5. **Piping.**

## Mixed System Type 1: High System Turndown

The following examples are of mixed boiler systems with high effective system turndown and fault tolerance built in. When boiler types are the same, the system turndown is limited to the boiler's min input and fault tolerance is always present. When the system has mixed boiler types, consideration needs to be taken on what types can be mixed properly to achieve a high system turndown and provide some fault tolerance.

Fault tolerance allows for one boiler in the Priority 1 system to fail and any boiler(s) in the Priority 2 system to fail and still provide near linear (continuity) BTU response when adding boilers. This is illustrated in the following examples using the Boiler System Response graphs.

The CK Series/Futera III/Fusion-Series Mixed Boiler System (examples) is advantageous in providing low BTU input for light loads and high BTUs for heavy loads. The effective system turndown minimizes short cycling when light loads are present by assigning smaller boilers to Priority 1, running them first, and then stopping them last.

**NOTICE** In order to achieve the high effective turndown, smaller boilers are required (plumbing considerations need to be considered here due to differing flow/volume characteristics through the large and small boilers).

**Example Systems:**

**Figure 4** Non-Mixed Boiler System Examples

System MMBTU	Effective Turndown	MOD MAX	CK 5:1
24.0	20:1	70%	6000, 6000, 6000, 6000
12.0	20:1	70%	3000, 3000, 3000, 3000
6	20:1	70%	1500, 1500, 1500, 1500

With the traditional Non-Mixed boiler system, the effective turndown increases by the turndown ratio for every boiler added. The min fire rate is equal to the minimum BTUs that can be delivered to the system.

Number of boilers \* Turndown Ratio = Effective System Turndown: 5 \* 5:1 = 25:1.

**Figure 5** Mixed Boiler System Examples

System MMBTU	Effective Turndown	MOD MAX	Priority 1 CK 5:1	Priority 2 CK 5:1
8.0	26:1	45%	1500, 1500	2500, 2500,
9.0	30:1	50%	1500, 1500	3000, 3000
9.5	30:1	50%	2500, 2500	5000, 5000

With the mixed boiler system, a lower minimum fire rate/BTU can be delivered to the system by using small boilers with larger boilers. This works in much the same way as base loading.

**Figure 6** CK Series 1500 – 4000 Modulation Parameters

CK Series	1500	2000	2500	3000	3500	4000
Max Input	1500	2000	2500	3000	3500	4000
Min Input 5:01	300	400	500	600	700	800
Mod Max 80%	1200	1600	2000	2400	2800	3200
Mod Max 70%	1050	1400	1750	2100	2450	2800
Mod Max 60%	900	1200	1500	1800	2100	2400
Mod Max 50%	750	1000	1250	1500	1750	2000

**Figure 7** CK Series 4500- 9000 Modulation Parameters

CK Series	4500	5000	6000	7000	8000	9000
Max Input	4500	5000	6000	7000	8000	9000
Min Input 5:1	900	1000	1200	1400	1600	1800
Mod Max 80%	3600	4000	4800	5600	6400	7200
Mod Max 70%	3150	3500	4200	4900	5600	6300
Mod Max 60%	2700	3000	3600	4200	4800	5400
Mod Max 50%	2250	2500	3000	3500	4000	4500

When selecting the **Priority 1** boiler(s) for a high effective system turndown, the BTU Min Input is selected first. (See: CK/Futera III/Fusion Boiler Btu Chart). Next, the MOD-MAX value of this Priority 1 boiler needs to be greater than:

$$\text{Mod MAX \%} = \frac{(\text{Priority 1's Min Input} + \text{Priority 2's Min Input})}{\text{Max Input of the Priority 1 boiler}}$$

The reason for this is to keep the continuity of BTUs linear without a BTU bump (discontinuity) when boilers are added or shed. The Mod Max % can be adjusted to the high side to allow for tolerance (about 10%) as is indicated in the tables. This is illustrated in the *Boiler System Response 2* graph.

If redundancy is not required, the min inputs of the Priority 1 boilers may be summed to lower the Mod Max % value so smaller Priority 1 boilers can be used. The sum of the min inputs would then need to be divided by the sum of the Max Input of the Priority 1 boilers. The effect of this would create a higher turndown. See: *EXCEPTION NOTES*:

**Mod MAX % =**

$$\frac{((\text{Priority 1 Min}) * (\#\text{Priority 1's})) + \text{Priority 2 Min}}{\text{Max Input of Priority 1 boiler} * (\#\text{Priority 1's})}$$

Example: (2) CK 1500, (2) CK 2500  
 Redundancy: (300 + 500)/1500 = 53%  
 No Redundancy: (300 \* 2) + 500 / (1500\*2) = 36%

In this example, if “Redundancy” is used, the variable “# of Priority 1’s” is not used.

**EXCEPTION NOTES:**

- Mixing more than two different size/type boilers becomes more complex than the scope of this manual and is not recommended.
- If using more than one Priority 1 boiler and the calculated value is <

$$\frac{\text{Priority 1Min} * 2}{\text{Priority 1 Max Input}}$$

**Use this result PLUS note 3 value as the ModMax %.**

- Always add a few % (3-5%) to the calculated MOD MAX % value to allow a guard band (tolerance).
- If boilers are of different sizes, try to use larger Priority 2 boilers.

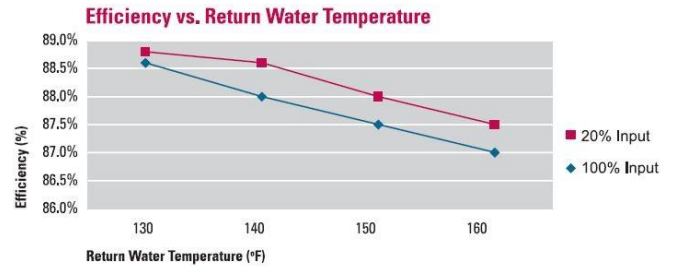
**If the calculated Mod MAX % value is greater than 99%, the combination cannot be used since short cycling will occur.**

Once the Priority 1 and Priority 2 boilers are selected, they can be multiplied in each Priority set to achieve the desired system design BTUs. If the # of boilers becomes a large number, a Priority 1 boiler with a higher Min Input may need to be selected.

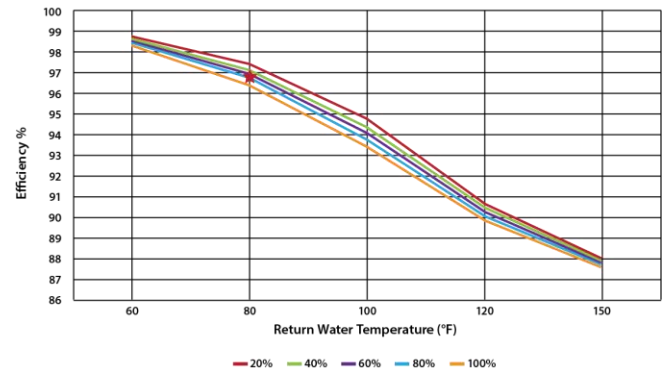
While considering the MOD-MAX value, the lower the MOD-MAX the greater the combustion efficiency since it effectively limits the input rate. The Typical Efficiency of

Non-Condensing Boilers chart can help illustrate how the MOD-MAX value can affect the efficiency by limiting the input until all boilers have fired. Non-condensing boiler efficiency is relatively flat compared with condensing as illustrated in the Typical Efficiency of Condensing Boiler graph.

**Figure 8** Typical Efficiency of Non-Condensing Boilers

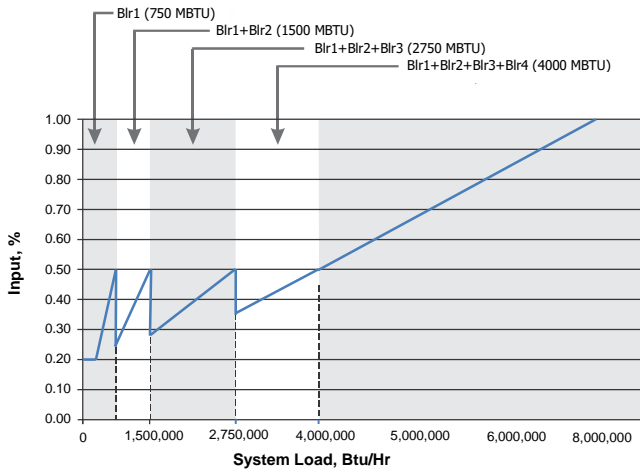


**Figure 9** Typical efficiency of Flexcore boilers

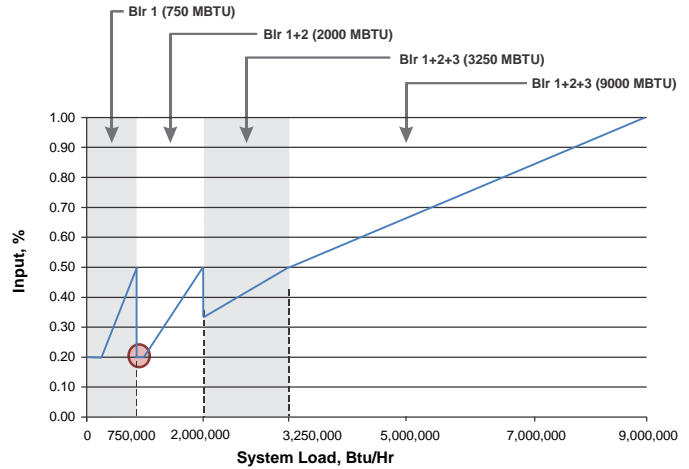


In the Mixed Boiler System table line 1 example, (2) CK 1500s are set as Priority 1 and (2) CK 2500 boilers are set as Priority 2. With a MOD MAX of 50% (Redundancy), each 1500 can run to 750M (1500M total) before a 2500 is called ON (Add Delay timer). Once both 1500s are running and the 2500 is called on, all (3) boilers will drop to a sum of 1500M BTUs: Taking this 1500M value and dividing by total M BTUS of the (3) boilers, 1500 + 1500 + 1750 = 5500, we get 27.27%. (.2727 \* 1500M) + (.2727 \* 1500M) + (.2727 \* 2500M) or: 409M + 409M + 681M = ~1500M and operate at higher combustion efficiencies

**Figure 10** Boiler System Response 1  
(2) CK 1500s, (2) CK 2500's



**Figure 11** Boiler System Response 2  
(1) CK 1500, (3) CK 2500, 50% Mod-Max



**NOTICE** When running non condensing boilers at low input rates, the risk of condensing should be considered.

The *Boiler System Response 1* chart illustrates how each boiler (in the example) is brought on and fires to 50%, drops to a lower fire rate and then adds the next boiler (vertical dashed lines). Once all boilers are firing, the modulation is released allowing all boilers to fire to 100%.

Now, if (1) CK 1500 (one of the CK 1500s was taken offline) were used with (2) CK 2500's and the Mod-Max is set to 50%, the CK 1500 would fire to 750 MBTUs and wait for the CK2500 (*Boiler System Response 2* graph). Now, the minimum input rate would be 500M (CK 2500) + the 300M (CK 1500) (already running, but dropped to low fire, but it needs to go to 18.75%, when the CK 2500 starts), the total being 800M. The turndown limits the boiler to running at a minimum of 20%. With a 50% MOD-MAX clamp, there would be 50 MBTUS more than needed that would be added to the system when the CK 2500 fired.

The PID algorithm would then compensate for the discontinuity (bump) in BTUs and the CK2500 would short cycle. To compensate for this, the Mod Max percent would need to be increased by 3%, but should be increased by at least 5% to 55% to allow tolerance. 10% is a better tolerance choice if room is available. This allows the load to fluctuate without causing short cycles.

$$1500 * .55 = 825 \text{ MBTUS.}$$

This new Mod-Max value will allow the sum of the low fire BTUs of both boilers to fire at;  $300 + 500 = 800$  MBTUs with room of 25 MBTUs, and prevent the short cycle condition.

While a CK 1500 running with a CK 2500 is an acceptable solution, it may not be an optimal choice unless (2) CK 1500s are used in the Priority 1 set and one is allowed to be taken offline (for Redundancy).

A system employing this redundancy where (1) is allowed to be taken offline is listed in the *MIXED BOILER SYSTEM* chart. This system uses (2) CK 1500s and (2) CK 2500s. Two of the CK 1500s are treated as one when adding the min inputs of the Priority 1 set.

In summary, the system should be tuned using the boiler selection charts and the MOD-MAX value. Since selecting the Priority 1 boiler is integral to the fault tolerance of the system, it is important to note any discontinuities in BTUs if a Priority 1 boiler fails when multiple Priority 1 boilers are used.

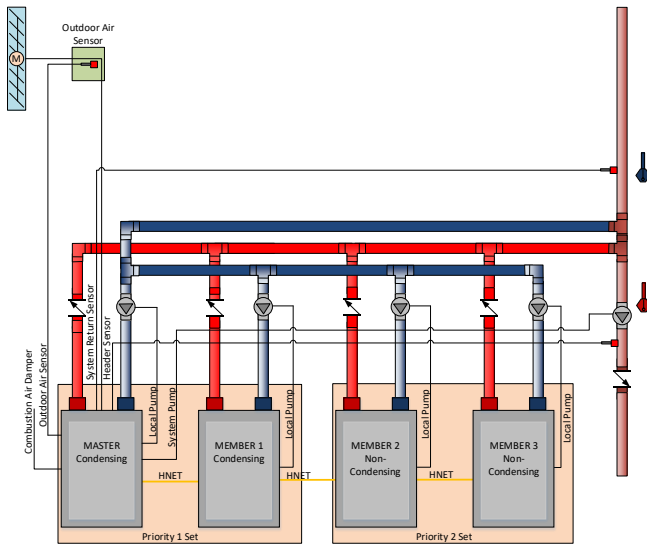
## Mixed System Type 2: Condensing/Non-Condensing

In the following examples, condensing boilers will be used with non-condensing mass boilers. The reason for creating a mixed system is primarily to control the system cost.

Note: In a mixed condensing/non-condensing system, boilers with differing sizes, as outlined in the Mixed System Type 1: High System Turndown section may also be used.



**Figure 12** Mixed Condensing/Non-Condensing Boiler System



*Note: The example drawings in this section are simplified. They are meant to illustrate connections to the HeatNet V3 control. Only major components are illustrated. The system engineer must ensure additional safeties, piping, maintenance valves, and components meet code requirements and safe operation.*

**Figure 13** Mixed Boiler System Examples

System MMBTU	Effective Turndown	MOD MAX	Priority 1 CK 5:1	Priority 2 MB/MW
7.5	25:1	55%	1500, 1500	4:1 1500, 1500, 1500
10.5	35:1	60%	1500, 1500	5:1 2500, 2500, 2500
18	30:1	55%	3000, 3000	5:1 4000, 4000, 4000
24	26:1	55%	4500, 4500	5:1 5000, 5000, 5000

**Figure 14** Futera III/Fusion/ Boiler Btu Chart (MBH)

MB/MW CB/CW	500	750	1000	1250	1500	1750	2000
Max Input	500	750	1000	1250	1500	1750	2000
Min Input 4:1	125	188	250	312	375	437	500
Mod Max 80%	400	600	800	1000	1200	1400	1600
Mod Max 70%	350	525	700	875	1.05	1220	1400
Mod Max 60%	300	450	600	750	900	1050	1200
Mod Max 50%	250	375	500	625	750	875	1000

**Figure 15** Futera XLF Boilers

MB/MW	2500	3000	3500	4000	5000
Max Input	2500	3000	3500	4000	5000
Min 5:1	500	600	700	800	1000
Mod Max 80%	2000	2400	2800	3200	4000
Mod Max 70%	1750	2100	2450	2800	3500
Mod Max 60%	300	450	600	750	900
Mod Max 50%	1250	1500	1750	2000	2500

For the examples, the RBI FIII/Fusion series water heaters will be used. These boilers are non-Condensing, fully modulating, low mass, and HeatNet compatible.

If CB/CW Fusion boilers are substituted for the MB/MW Futera III boilers, the efficiency is greatly increased due to the condensing mode of these boilers. When using CB/CW Fusion boilers, at lower firing rates, the combustion efficiency is maximized by running the CB/CW Fusion boilers from low to middle input rates. See: *Typical Efficiency of Condensing Boiler* graph.

The *Mixed Boiler System* table show some examples of mixed systems using different sizes along with Fusion condensing (Priority 1) and Futera III non condensing (Priority 2) boilers.

Using the boiler charts and the examples used in: *Mixed System Type 1: High System Turndown*, a mixed boiler system can be designed. The Priority 1 boilers should be setup so as to keep the non-condensing boilers from seeing return water temperatures of less than 140F to ensure a long heat exchanger life.

Normally, the Priority 1 boilers (Condensing) will be set to fire first. Once all the Priority 1 boilers are firing, the next boiler to fire (after the ADD BOILER timer expires) would be the Priority 2 (non-condensing). If the return water temperature has not come up to ~140F, the non-condensing boilers could fire in a condensing mode. The ADD BOILER delay timer would have to be set to a long enough period to ensure this does not happen. Even then, the load may be too great.

When running with a remote BMS setpoint, care must be taken that an Outside Air reset setpoint (or other setpoint) sent by the BMS is not set too low. If the BMS system is controlling the setpoint close to the condensing temperature, the return water temperature may never rise sufficiently to keep boilers out of a condensing mode. HeatNet online is a good way to monitor this scenario if suspected.

The following note will explain an alternative way (not depending on the ADD BOILER DELAY) to keep non-condensing boilers from firing in a condensing mode.

#### NOTE:

*If the firmware version for a HeatNet V2 board is at least 3.47(or a version 3 board), the non-condensing boiler may hold itself off from being added to the HeatNet Master's available to fire list. This would effectively keep the non-condensing boiler from firing in a condensing mode, but as a result, may not satisfy the system setpoint.*

*In order to use this feature, the version 2 board would need to monitor the system or local return temperature. This can be done locally by setting SETUP: AUX FUNCTIONS: HEAT EXCHANGER: TEMP DISAB: RETURN if there is no pump/valve limiting flow continuously through the boiler. If there is a pump/valve limiting the flow through the boiler, the SETUP: AUX FUNCTIONS: HEAT EXCHANGER: TEMP DISAB: SYS RET needs to be set. Then the Master boiler needs to set SETUP: AUX FUNCTIONS: HEAT EXCHANGER: SEND RETURN: to which of its return temperatures it would send to all boilers. These include the Local Return temperature or the System Return temperature.*

*The Member's menu "SETUP: AUX FUNCTIONS: HEAT EXCHANGER: TEMP DISAB:" if set to RETURN or SYS RET, will force the boiler to become unavailable to HeatNet when the SETUP: AUX FUNCTIONS: HEAT EXCHANGER: TEMP < 140F. This value is adjustable to 135F if a forced air fan is used. When the SYS RET or RETURN temperature is <140F the boiler responds to a*

*HeatNet Master's request as "unavailable". As soon as the return temperature reaches 140F, the boiler will respond to the Master's request that it is available to fire.*

*If the Master boiler is a version 2 board, the Master will always transmit its Local Return temperature to all boilers. If the Master is set to Priority 1 and all other non-condensing boilers are set to Priority 2, the Master should always remain on if there is a call for heat. This requires that the Priority 1 boiler be set up to start first and stop last. Using this method should always send a valid return temperature to the Member boilers. This method can also be used with a version 3 board, but a system return sensor is preferred.*

*When this condition is in effect, the STATUS \* screen will indicate "blr offline". While the boiler is in this "not available" state, it can still be fired locally and failsafe is still available.*

#### SETUP: AUX FUNCTIONS: HEAT EXCHANGER: SEND RETURN:

OFF	The Master sends its return temperature to all boilers
RETURN	The Master sends its return temperature to all boilers
SYS RET	The Master sends the system return temperature to all boilers

#### SETUP: AUX FUNCTIONS: HEAT EXCHANGER: LOW TEMP:

OFF	No check is made to the return temperature – boiler remains online
RETURN	Uses the boilers own return sensor (No pump /valve present)
SYS RETURN	Uses the System Return temp received from the Master Boiler (its Local or System Return).

#### SETUP: AUX FUNCTIONS: HEAT EXCHANGER: TEMP < 140F

This is the adjustable threshold temperature below which the boiler will take itself offline.

(1) Degree F of hysteresis is provided so as to not toggle offline<-to->online at the threshold temp.

Since the FIII boiler is non-condensing, the efficiency vs. input is relatively flat. The MOD MAX value will not have the same impact if the FIII non-condensing boilers were placed in the Priority 1 set.

In a mixed condensing/non-condensing boiler system example: (2) CK 1500s are set as Priority 1 and (3) MB/MW 2500s are set as Priority 2. With a MOD MAX of 60%, each CK 1500 can run to 900M (1800M total) before a MB/MW 2500 is called ON (Add Delay timer). Once both CK 1500s are running and the CK 2500 is called on, all (3) boilers will drop to a total of the 1800M BTUs. Taking this 1800M value and dividing by total M BTUS of the (3) boilers The sum of the CK 1500, CK 1500, and CK 2500 would equal about 32.7% modulation:  $(.327 * 1500M) + (.327 * 1500M) + (.327 * 2500M)$  or:  $490.5M + 490.5M + 817.5M = \sim 1800M$  and operate at higher combustion efficiencies: 32.7% is roughly between the top two lines on the Typical Efficiency of Condensing Boilers chart.

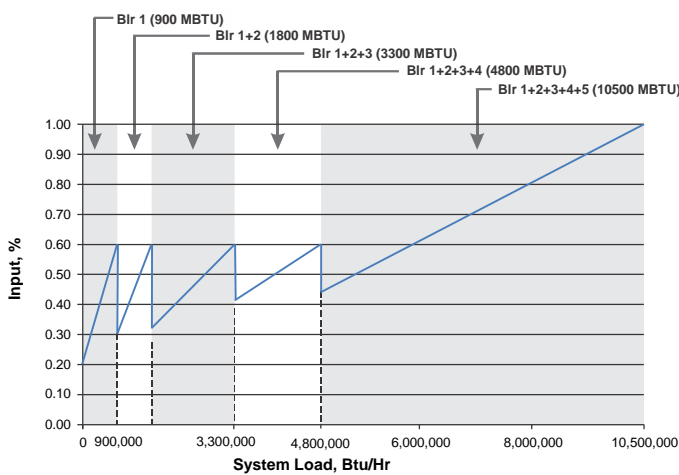
The 5:1 turndown of the boilers can allow the Mod Max clamp to go lower, but return water temperatures need to be taken into account to ensure the Priority 2 boilers don't enter a condensing state. Each system is different and adjustments to the Mod Max value can be adjusted to achieve the greatest efficiency.

The *Boiler System Response 5* chart illustrates how each boiler (in the example) is brought on and fires to 60%, drops to a lower fire rate and then adds the next boiler (vertical dashed lines). Once all boilers are firing, the modulation is released allowing all boilers to fire to 100%.

So, for the first 1800 MBTU of load, the combustion efficiency is maximized by running the (2) CK Series boilers from low to middle input rates. Running the (2) CK 1500 boilers first, also has the added effect of minimizing the return water temperatures of <140F from reaching the non-condensing boilers.

In summary, the system should be tuned using the boiler selection charts and the MOD-MAX value so that boilers are brought on and fired in their respective efficiency curve while maintaining continuity in BTUs. Since selecting the Priority 1 boiler is integral to the fault/offline tolerance of the system, it is important to note any discontinuities in BTUs if a Priority 1 boiler goes offline when multiple Priority 1 boilers are used.

**Figure 16** Boiler System Response 5  
(2) CK 1500s, (3) MB/MW 2500s



## Heating Control Methods

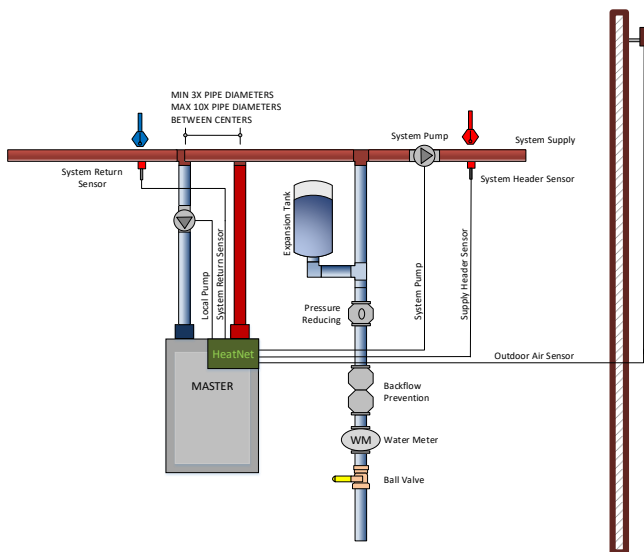
An overview of the (5) methods for controlling the FlexCore CK -Series boiler are presented here. They are outlined in more detail at the end of this section.

### Heating Method 1

The first method is to use the FlexCore CK -Series boiler in its stand-alone modulating method. This method uses a PID algorithm to maintain a setpoint and is enabled using the HEAT DEMAND input. Closing a relay contact or switch across the HEAT DEMAND input will cause the Master boiler to control all member boilers using H-Net.

A member boiler may also be controlled by the HEAT DEMAND input (LOCAL mode). The member boiler will then ignore commands from the Master and maintain its LOCAL SETPOINT at the supply sensor.

**Figure 17** Basic Single Boiler



**Note:** The example drawings in this section are simplified. They are meant to illustrate connections to the HeatNet V3 control. Only major components are illustrated. The system engineer must ensure additional safeties, piping, maintenance valves, and components meet code requirements and safe operation.

### Heating Method 2

The second method is to view the FlexCore CK -Series boiler as two separate boilers or as a HIGH/LOW boiler using T1 & T2.

### Heating Method 3

The third method is to allow a remote 4-20 mA or 0-10 VDC signal to control the firing rate (modulation) of the boiler using the 4-20 mA input, along with the 4-20 mA REMOTE ENABLE input.

### Heating Method 4

The fourth method turns the boiler ON and OFF @ 100% modulation using the AA terminal.

### Heating Method 5

The fifth method uses an RS485 digital communications cable with the MODBUS protocol. The boiler is controlled by writing and reading registers using MODBUS commands. A bridge module may also be used to convert BACnet or LonWorks protocols to MODBUS.

#### NOTICE

Short cycling may occur when a firing rate is sent to a member boiler that would cause the supply temperature to raise high enough to trip the operating limit (low flow rate). After the supply temperature falls, the boiler would restart and the process may continue. A member boiler would use its supply (outlet) sensor to protect itself from short cycling by limiting the firing rate coming from the Master. This occurs in the event that the member's supply temperature increases above the (OPERATE LIMIT - OPERATE LIMIT BAND).

### Operating Limit

When the Master boiler or an external control input is used to control a member boiler (i.e. AA, T1-T2, 4-20 mA, H-Net), a software operating limit on the member boiler will be used to limit the maximum output of the member boiler. This operating limit can be adjusted in the **SETTINGS: SETPOINTS: OPERATE LIMIT**.

There is also an associated operating limit band that must be set in conjunction with the operating limit to help prevent this LIMIT from being reached. Its purpose, is to limit the output of the boiler as it approaches the operating limit. If the band is set to 10 degrees, then for every degree that it approaches the operating limit, the maximum output will be lessened by 10%. With a band of 20 degrees, for every degree that it approaches the band, the maximum output will be lessened by 5%. You can think of this operating limit as a smart Aquastat which prevents the High Limit from tripping. This method minimizes boiler short cycling when using external inputs. The minimum setting is 1 degree and effectively turns the limit band OFF. The default setting is 20F.

## Input Priorities

The FlexCore CK-Series **control inputs are prioritized** so that multiple levels of external control can be employed at the same time. This means that if we are firing the boiler with a low Priority input and a higher Priority input is called for, the boiler will now fire at the higher Priority input. When the high Priority input is removed, the boiler will revert back to the lower Priority input that is still called.

### Priority 1

The AA terminal has absolute control, and if used, will always fire the boiler at 100% output, regardless of any other input. The 4-20 mA input may be raised to this Priority using **SETTINGS: 4-20 mA INPUT: PRIORITY**.

### Priority 2

The HEAT DEMAND input is the next, and provides the means to operate the boiler in LOCAL MODE when an external control is not present, has failed, or needs to be enabled or disabled. A member can override the H-Net commands using this input.

### Priority 3

If a HeatNet (H-Net) Network cable is connected between boilers, and one is configured as a MASTER (requires HEADER sensor), then the MEMBER boilers will be controlled over the network by the MASTER.

### Priority 4

The 4-20 mA/0-10VDC input in tandem with the 4-20 mA REMOTE ENABLE input is next. Any signal over 4.02 mA or 2.01VDC will start and operate the boiler if the REMOTE ENABLE is closed.

### Priority 5

The lowest Priority is using the boiler as (2) stages HIGH/LOW. These are the T1 and T2 inputs.

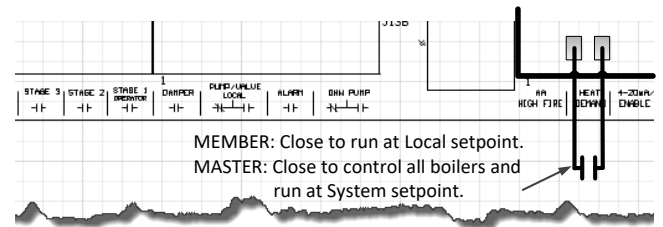
Each of these control methods will now be explained in more detail:

## Heating Method 1 HEAT DEMAND

Closing a relay contact, switch, or jumper across the HEAT DEMAND input will enable this method. This method allows operation as a setpoint control. As a setpoint control, the Master (defined by having a common system supply header sensor), on the H-Net network can command the boiler fire rate of all Member boilers. The Master can call as many boilers that it has available (boilers are auto-detected over the H-Net cable by the Master) to meet its **SYSTEM SETPOINT**. The H-Net cable must be connected and will cause the amber light on the communications board to flash. The amber light indicates an H-Net Master is broadcasting control information and a system heartbeat.

The AA terminal, the FAILSAFE mode active, 4-20 mA at PRIORITY: HIGHEST, and the HEAT DEMAND input (LOCAL) on a Member, are the only inputs that will override the H-Net control.

Figure 18 Heat demand input



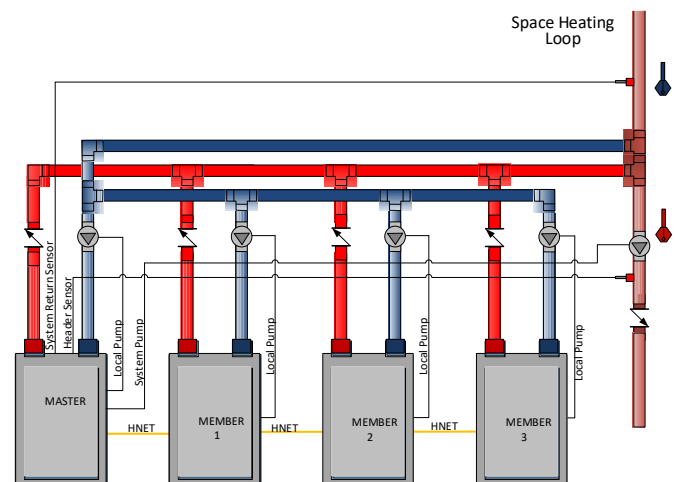
### Master boiler

The MASTER boiler controls the system using a PID algorithm. Once the boiler is started, a PID algorithm is used to produce a modulation percentage value from 0-100%. This percentage is converted to a PWM, (P)ulse (W)idth (M)odulation signal by each boiler. The temperature of the water is maintained by sending this PWM signal to the Variable Frequency Drive, which in turn controls the blower motor. Since the main fuel valve is air-fuel coupled to the blower, the speed of the blower provides the firing rate.

### Member boiler(s)

A Member (lacking a common system supply header sensor) boiler may also be controlled by the HEAT DEMAND input (LOCAL mode). The member boiler will then ignore commands from the Master and maintain its own LOCAL SETPOINT at its supply sensor. This can be viewed as a manual override on a member boiler. Be sure to observe the proper use of a Common System Damper (See: AUXILIARY FUNCTION OPTIONS section) and any system pumps or system common interlocks.

Figure 19 HeatNet Boilers Configured as Reverse Return



**Features of the HEAT DEMAND input include:**

1. The control is designed to **predict** when to start and stop the boiler and keep the setpoint in, or as close to the control band as possible. If PREDICTIVE START is enabled, the boiler may start when it is in the band and not below it. This will help to maintain a more accurate temperature relative to the setpoint. See also: SETTINGS: FIRING MODE: PREDICTIVE START: to disable this feature.
2. The control can also use the Outdoor Reset feature. This feature allows the setpoint to be changed automatically based on the outside air temperature. If this feature is used, the control input: OR OVR (OUTDOOR RESET OVERRIDE), can be used to override the Outdoor Reset feature and run from the local setpoint. A contact closure on the 'AA' input can also override this method.
3. The 4-20 mA setpoint control function works in conjunction with this mode. This function translates a 4-20 mA control signal to a setpoint mapped between 50F and 220F. These (2) temperatures are adjustable to provide a setpoint range. The minimum start current is also adjustable between 3.71 and 5 mA. The setpoint control feature is used in conjunction with the REMOTE ENABLE input on J12A. This feature is enabled in the SETPOINTS menu as:  
**SETPT SOURCE 4-20 mA**
4. There is also support for a common system damper, Heat Exchanger support, and starting the Master first for common venting. For an overview of each of the menu settings see: **DEFAULT SETTINGS** section.

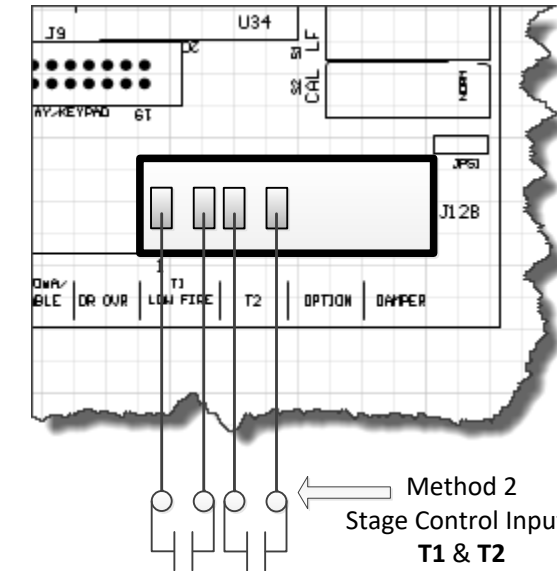
**Heating Method 2  
STAGE Control T1-T2**

The boiler can also be operated in 2 separate stages using the inputs T1 and T2 inputs. Its intended use is with an external stage controller with no analog or modulation outputs.

Closing only one of these contacts tells the boiler to operate at MINIMUM FIRE.

Closing the other contact will fire the boiler at MAXIMUM output (the same rate as closing the AA input).

**Figure 20** Stage control input



**NOTICE** The maximum output of the boiler is based on the MAX VFD setting in the calibration mode and not the nameplate rating.

The AA, HEAT DEMAND (LOCAL) input, the H-Net, the 4-20 mA input will all override the stage control inputs.

**Heating Method 3  
4-20 mA Control**

Placing a current source between the + and - 4-20 mA inputs will allow remote control of the boilers firing rate. An adjustable starting mA current signal here will start and then fire the boiler at the minimum fire rate. See: **SETTINGS: 4-20 mA INPUT: CHANNEL MODE.**

See section OPTIONAL FEATURES Using the 4-20 mA input for extensive detail.

A 20 mA signal will fire the boiler at the maximum firing rate. The input current signal is viewed as a percentage to the boiler from 0 to 100% (0-20 mA). This means that a 20% (4mA) input signal is required to start the boiler, but since the boiler is classified as having example: 4:1 turn down ratio, the boiler can only be fired as low as 25% of output. Any signal between 20% and 25 %, will fire the boiler at the minimum fire rate. If the MINIMUM setting of the boiler is set above the example: 4:1 turndown of 25% (such as 33%), a control signal change between 25% and 33% will not change the boilers firing rate. Once the control signal rises above the MINIMUM fire rate, the control signal will then affect control of the boilers fire rate.

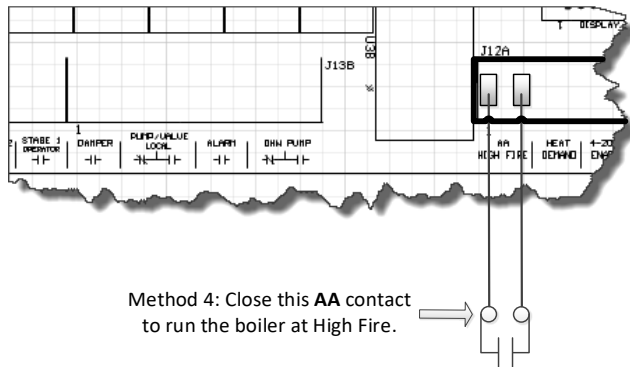
The AA terminal, the HEAT DEMAND, and the H-Net NETWORK are the only inputs that will override the 4-20 mA input.



## Heating Method 4 AA Input

HIGH FIRE input Control: The AA input will fire the boiler at HIGH fire (maximum output of the boiler). No other inputs can override this input.

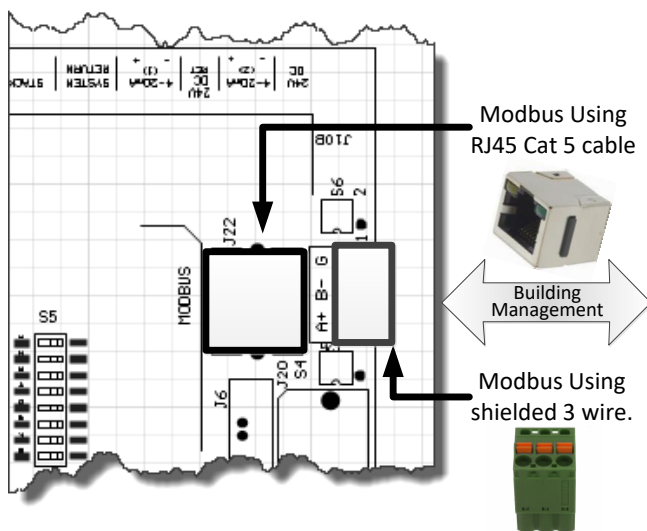
**Figure 21** AA — High fire input



## Heating Method 5 MODBUS communications

The fifth method uses an RS485 digital communications cable with the MODBUS protocol to control the boiler using the H-Net network. The Boiler or Boiler network will run as in Method 1, but instead of the HEAT DEMAND input, a software form of the HEAT DEMAND input is used (40001: Boiler/System Enable/Disable). See: MODBUS COMMUNICATIONS section.

**Figure 22** MODBUS connections



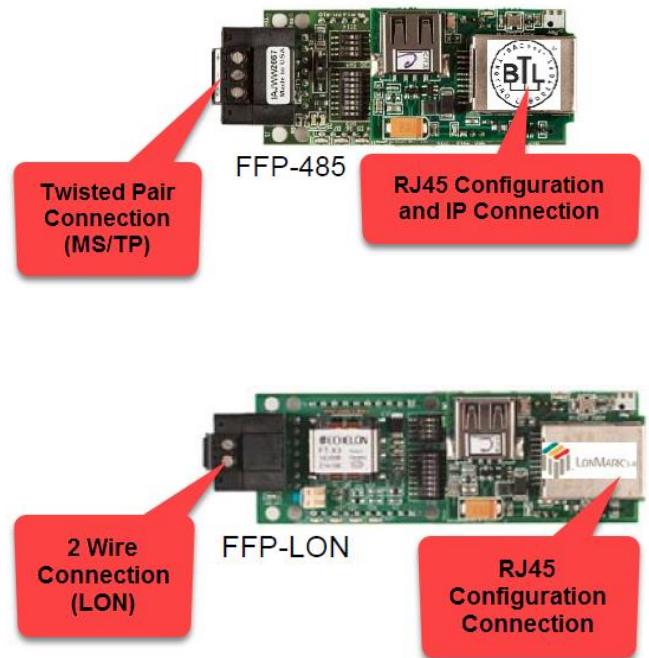
The System Setpoint Timer also needs to be loaded periodically to allow the H-Net system to fallback to Method 1 in the event communications is lost from the Building Management System (BMS).

This feature can be turned off in SETTINGS: COMMUNICATIONS: SETPOINT TIMER: OFF. If the setpoint timer feature is set to ON, the SETTINGS: COMMUNICATIONS: SETPOINT TIMER may be set to a time that allows any write to a MODBUS register to reset the setpoint timer as long as it occurs within that time. This will reset the setpoint timer without writing the setpoint timer register. So, periodically writing the setpoint register will automatically reset the setpoint timer as long as the write occurs within that time window.

### Processor option

An optional BACnet or LonWorks bridge module can be used to connect the MODBUS network to a BACnet or LonWorks network.

**Figure 23** Processor bridge module option

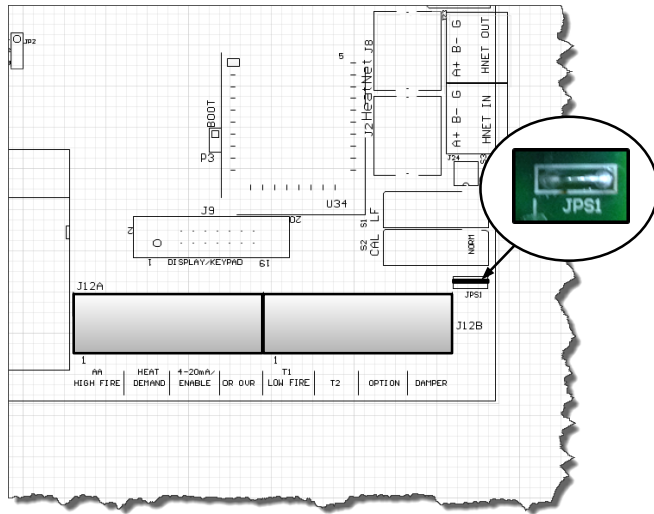


This method allows enabling and disabling the boiler or H-Net system, changing setpoints, reading boiler(s) status, or temperatures remotely using digital commands. See the section: MODBUS Communications.

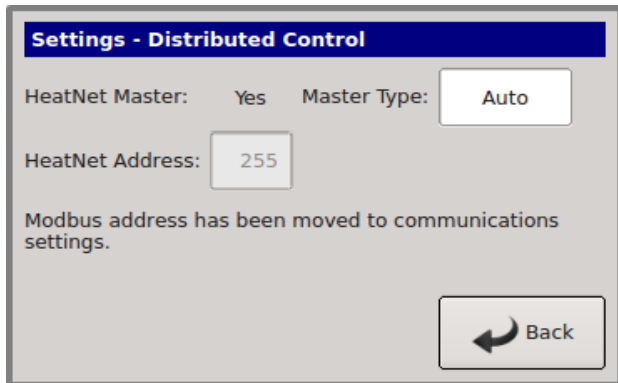
# Domestic Hot Water Methods

Domestic Hot Water control is supported using (6) methods. When using the Domestic Hot Water methods, the wire jumper, JPS1 on each control board providing Domestic Hot Water, must be cut to limit the boiler's maximum output temperature to 200F. Refer to **Figure 41** for control input and **Figure 49** for output locations.

**Figure 24** Jumper JPS1



**Note:** Most of these methods use a separate PID control for the DHW. This means that the Master boiler can be used to individually control its own DHW tank and provide space heating functionality at the same time.



A **MASTER TYPE** is required when using DHW. Its setting is located under the **DISTRIBUTED CONTROL** menu. Any time its setting is changed, a power cycle is required. The menu choices are:

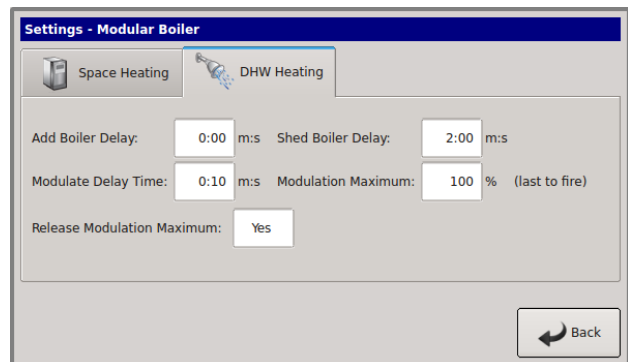
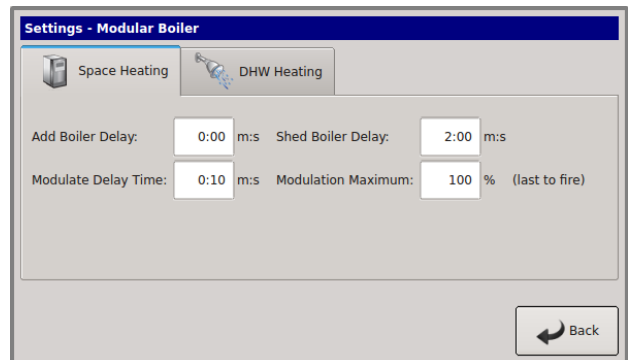
**AUTO:** will handle normal heating only applications. It may also be used when individual boilers have tanks connected and are controlled with the **DHW BOILER?** set to **LOCAL**.

**DHW:** is for **DHW** applications without space heating.

**Combination:** Will allow combination Space and DHW heating control of boilers by the Master.

The OR OVR input now functions in many of the methods as a DHW Heat Demand input (except **DHW Heating Only** method), but still retains the original OR OVR functionality in **AUTO**, if the DHW menus are not used (**BOILER MODE? OFF**). If the **DISABLE TO CHANGE** message appears, remember to remove the any call for heat including the OR OVR input.

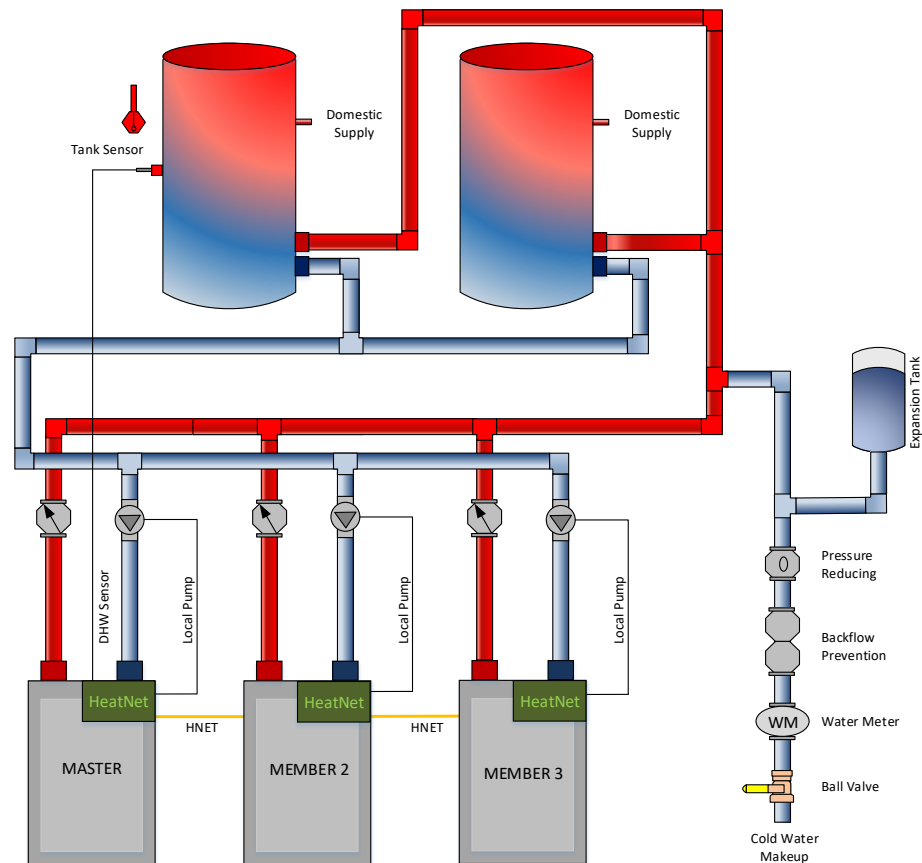
When the **MASTER TYPE** is set to **Combination** the **MODULAR BOILER** menu will contain (2) separate menu tabs for controlling the **ADD BOILER DELAY**, **SHED BOILER DELAY**, **MODULATE DELAY**, and the **MOD MAX** for the **SPACE HEATING** and **DHW HEATING**. This allows the independent control of boilers by the Master for each of the (2) PIDs.





## DHW Method 1: DHW Heating ONLY using a DHW MASTER and Member Boiler(s) Employing H-Net

Figure 25 Example DHW Only, Reverse Return Piping – Method 1.



### DHW METHOD 1: DHW Heating ONLY using a DHW MASTER, Multiple Non-Condensing Boilers

A DHW Setpoint is maintained in the DHW tank based on the Master's DHW Sensor. The system pump is enabled when the boiler's *Heat Demand* input is closed. Boilers are staged to meet the DHW Setpoint in the tank based on their runtime, and each boiler will enable its local pump when it is running. The Master modulates the boilers to maintain the setpoint in the tank.

The cold water make up is piped into the supply piping to reduce the possibility of condensing in the boilers.

**Figure 26** DHW Method 1 *Quick Start* Settings

**DHW METHOD 1: DHW Heating ONLY Using a DHW MASTER and Member Boiler(s)**

Master (DHW Only)			
<b>Settings</b>			
DHW Use Sensor	HeatNet Address	Master Type	Combustion Air Damper
Yes	Automatic	DHW Only	Off
<b>Inputs</b>			
Local/Remote	DHW Sensor	JPS1 Jumper must be cut to service DHW	
Local	Yes - Tank		
<b>Outputs</b>			
Local Pump On			
When Boiler Running			

Member 2		
<b>Settings</b>		
HeatNet Address	Combustion Air Damper	
2	Off	
<b>Inputs</b>		
Local/Remote	JPS1 Jumper must be cut to service DHW	
Remote		
<b>Outputs</b>		
Local Pump On		
When Boiler Running		

Member 3		
<b>Settings</b>		
HeatNet Address	Combustion Air Damper	
3	Off	
<b>Inputs</b>		
Local/Remote	JPS1 Jumper must be cut to service DHW	
Remote		
<b>Outputs</b>		
Local Pump On		
When Boiler Running		

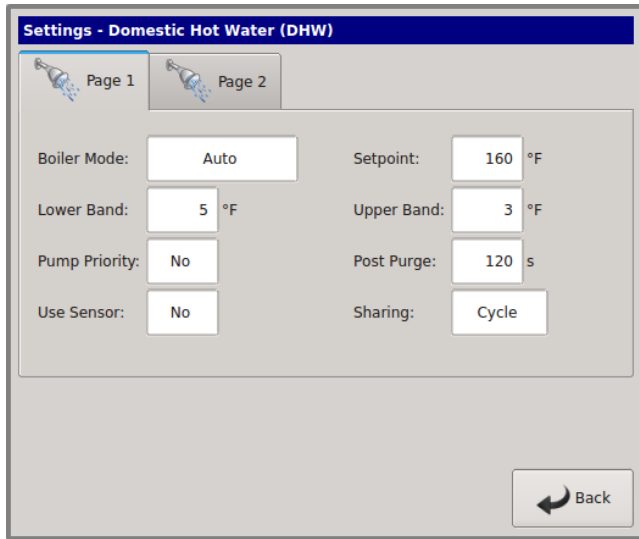
**Note:** The example drawings in this section are simplified. They are meant to illustrate connections to the HeatNet V3 control. Only major components are illustrated.

The system engineer must ensure additional safeties, piping, maintenance valves, and components meet code requirements and safe operation.

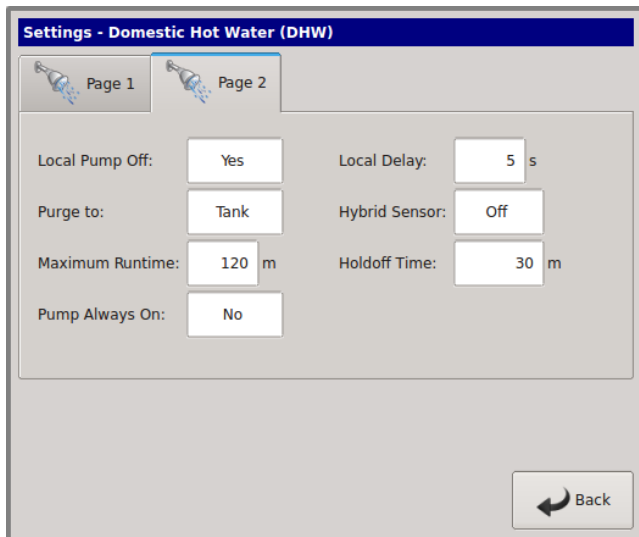
This method requires a 10k thermistor connected to the DHW Sensor input of a DHW MASTER, or a stand-alone boiler, and a DHW tank. This method does not use a HEADER sensor. The DHW temperature is maintained by the space heating PID for backwards compatibility. With this method the OR OVR input does not function as a DHW enable and is not used. The Heat Demand input is used to enable/disable DHW heating operations.

The system pump is enabled on the Master as long as the Heat Demand input is closed. The Master's DHW pump is engaged only when there is a call for DHW heating by the system. This allows for a DHW loop/buffer and A DHW tank that can be heated using the Master's DHW pump (Reverse/Return only) or each boiler's Local Pump/Valve off of this loop/buffer.

**DHW Page 1**



**DHW Page 2**



Boilers are started as long as the tank's water temperature is below the (DHW SETPOINT – LOWER BAND). The first boiler is started immediately. The next boiler(s) is started after the ADD BOILER DELAY time expires. Boilers are not added when the temperature is above the (DHW SETPOINT – LOWER BAND) and below the UPPER BAND. Once the UPPER BAND is exceeded, boilers will shut off based on the SHED BOILER DELAY TIME.

Setting up this method is done via the menus in: **SETTINGS: DOMESTIC HOT WATER.**

Connect a 10k thermistor from the DHW tank's sensor well to J10B terminals on the DHW MASTER, or stand-alone boiler. Wire a pump or valve from the DHW pump or the System pump (normally open) relay contact to control flow of the heating water into the tank's coil or system loop.

The System pump will always be enabled as long as the Heat Demand input is closed. The DHW pump will be enabled whenever there is a DHW call for heat.

A DHW call for heat is when the DHW temperature is below the (DHW SETPOINT – LOWER BAND) or when the DHW temperature is below the (DHW SETPOINT + UPPER BAND) and boilers are firing. After a DHW call for heat ends:

A. The pump will remain on during a post purge pump cycle until the post purge timer expires.

1. Next, enter the **DOMESTIC HOT WATER** menu on the Master boiler. In the **BOILER MODE selection**, enter **OFF**. The Master uses this method as a DHW system much like a space heating system.

Member boilers may set the **BOILER MODE** to **LOCAL** and go offline to perform secondary DHW heating, but the Master setting must be set to **OFF**.

Setting the **BOILER MODE** to **Combination** using this method may cause erratic operation and the DHW pump to not be enabled.

2. Change the **DHW SETPOINT** to the desired target temperature of the water in the tank. Once the control determines there is a call for DHW, the DHW SETPOINT is loaded and the Master boiler will target the setpoint.

3. Now, change the **LOWER BAND** to the desired temperature (DHW SETPOINT – LOWER BAND) below which boilers are to be added. This setting corresponds to the minimum water temperature required in the tank. DHW heating will be initiated when the DHW tank's water temperature is below the temperature (DHW SETPOINT – LOWER BAND).

How long the temperature of the tank stays below the temperature (DHW SETPOINT – LOWER BAND) is

used to determine when boilers are started along with the ADD BOILER DELAY TIME.

4. Next, change the **UPPER BAND** to the desired temperature (DHW SETPOINT + UPPER BAND) above which boilers are to be shed. This setting is the maximum tank temperature. Setting the SHED BOILER DELAY TIME correctly will limit the maximum tank temperature to the (DHW SETPOINT + UPPER BAND). Setting the SHED BOILER DELAY TIME = 0 will shut off all boilers immediately once the (DHW SETPOINT + UPPER BAND) is exceeded.
5. Now, determine if the DHW priority is required by the menu item **PUMP PRIORITY?**. Setting this value to YES will turn OFF the system pump when the DHW mode is active. Setting this value to NO leaves the system pump on.
6. Select the amount of time for the **POST PURGE** of the DHW pump. This is the time that the DHW pump relay remains energized after the DHW SETPOINT has been satisfied.
  - A. The pump will remain on during a post purge pump cycle until the post purge timer expires.
  - B. Pump on the Master boiler functions as a global pump.
7. Now, in order to be a Master boiler, it must have a Header sensor. In method 1 DHW Only, we will employ the DHW sensor (J10-A, 9 & 10) in this system instead of a Header sensor? **USE SENSOR** in this example will be set to **YES**. This will allow the boiler to control the DHW tank or system loop temperature as a Master boiler using the DHW sensor. The upper and lower differential temperatures will also be loaded.
8. The **SHARING** item is set to **OFF**, only boilers that are not firing will be checked for runtimes and fired.

9. Set the **LOCAL PUMP OFF** value to **NO**. This will leave the local pump on during a DHW heating cycle (backwards compatibility). Setting this value to YES will always keep the local pump off.

The Master's DHW relay will remain on as long as there are boiler's firing and the DHW temperature is below the (DHW SETPOINT + UPPER BAND). Once all boilers are off and the DHW temp is equal to or above the (DHW SETPOINT + UPPER BAND), the DHW pump will begin its post-purge time. If during this post-purge time the DHW temp falls below the (DHW SETPOINT + UPPER BAND), the DHW pump will remain on.

Setting this value to **YES**, will shut the local pump off during a DHW heating cycle, but will keep the local pump on for the LOCAL DELAY: 10s time before shutting off. This LOCAL DELAY: time can be adjusted in the next menu item by pressing the down arrow again.

10. Press the DOWN arrow again and the menu item: will be displayed.

Set the **PURGE TO** value to **TANK**. This will purge the heat from the boiler into the tank or system loop. This will be done using the DHW pump after the DHW heating cycle is complete.

If the **PURGE TO:** is set to **SPACE**, once the DHW cycle has completed, the Master will shut the DHW pump off within a few seconds. The **SPACE** setting should only be used only for combination space and DHW heating.

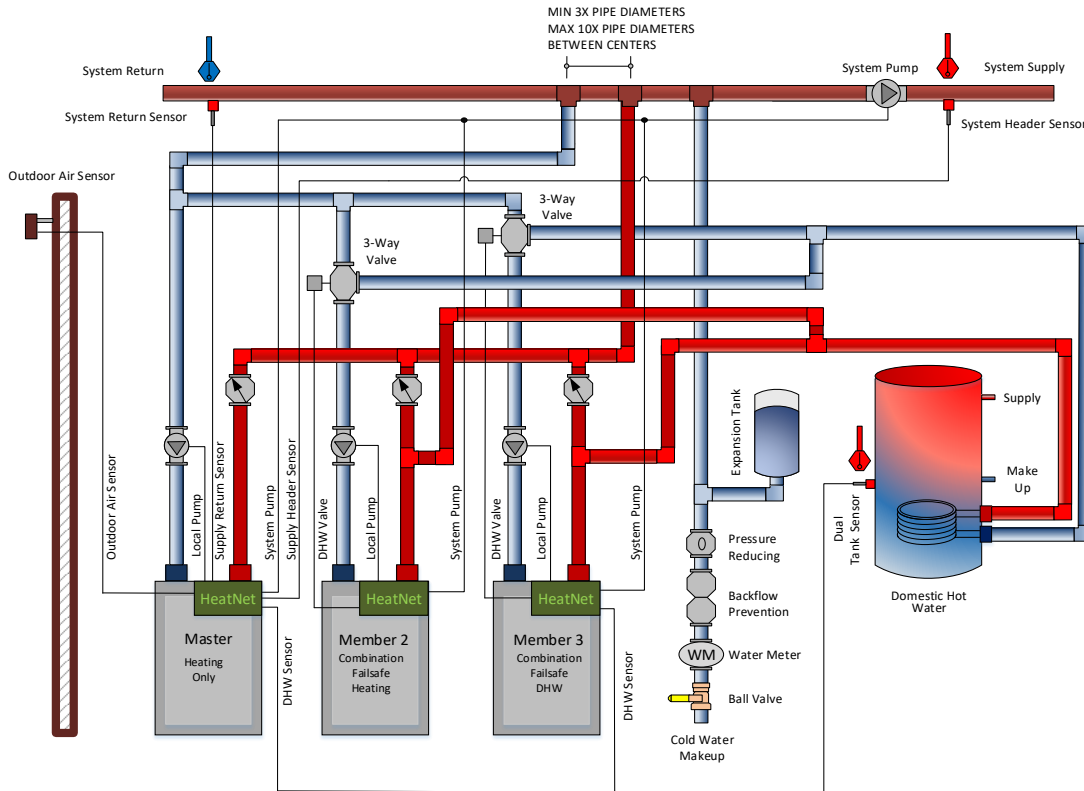
Now in the,

**SETTINGS: DISTRIBUTED CONTROL:**  
**MASTER TYPE** select **DHW**.

**NOTE:** JPS1 MUST be cut on all DHW boilers.

## DHW Method 2: Failsafe Combination DHW and Space Heating with a MASTER Boiler and Member Boilers Utilizing Valves (Master Type: Combination)

**Figure 27** In this example the Master is not a DHW boiler.



### DHW METHOD 2: Failsafe Combination DHW and Space Heating using a MASTER Boiler and Member boilers with valves

In this method the Master simultaneously controls both space heating and DHW heating. The Master is piped to only service space heating, and both members are piped to service space heating and DHW heating. The Master's *Heat Demand* input enables space heating by energizing the system pump and maintaining the Heating Setpoint at the System Header Sensor. The Master's **OR OVR** input enables the DHW heating, by maintaining the DHW Setpoint at the DHW Sensor located in the DHW tank.

Boilers are staged to meet both the Space Heating Setpoint, and the DHW Setpoint based on their runtime. When a boiler is fired to service a space heating demand it will enable its local pump, and when a boiler is fired to service a DHW demand it will enable its local pump and enable its DHW valve to divert water to the tank. The Master modulates the boilers in order to maintain the setpoints.

This method allows for a Member boiler to provide **Failsafe** mechanisms in the event the Master fails and stops communicating to the Members. Member 2 is configured to provide failsafe space heating, and Member 3 is configured to provide both failsafe space heating and failsafe DHW heating.

**Figure 28** DHW Method 2 W/Diverting Valves **Quick Start** Settings

**DHW METHOD 2: Combination DHW and Space Heating Using a MASTER Boiler and Member Boiler(s) Employing Diverting Valves**

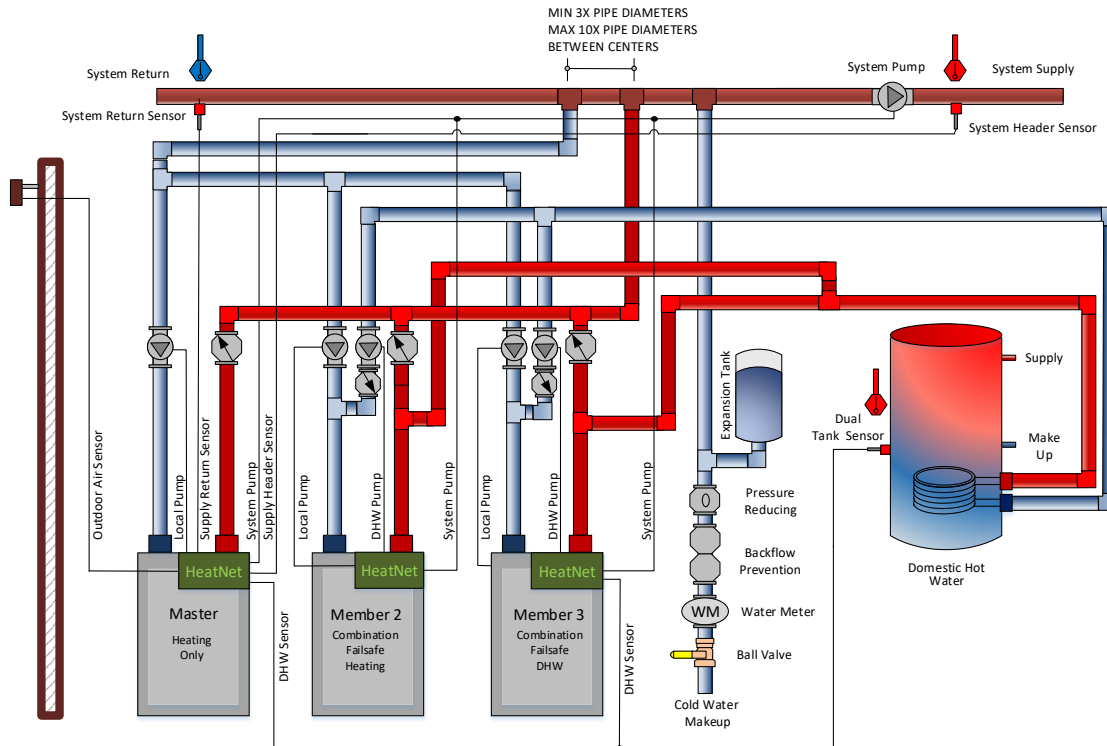
Master (Space Heating Only W/Valves)				
<b>Settings</b>				
Master Type	HeatNet Address	DHW Use Sensor	Combustion Air Damper	
Combination	Automatic	Yes	Off	
<b>Inputs</b>				
Local/Remote	OR/OVR	Header Sensor	System Return	DHW Sensor
Local	Jumper	Yes	Optional	Yes - Tank
<b>Outputs</b>				
System Pump On	Local Pump On			
When Boiler Enabled	When Boiler Running			

Member 2 (Space Heating Or DHW, Failsafe Space Heating W/Valves)				
<b>Settings</b>				
HeatNet Address	DHW Boiler Mode	DHW Local Pump Off	Combustion Air Damper	HeatNet Failsafe
2	Combination	No	Off	On
<b>Inputs</b>				
Local/Remote	JPS1 Jumper must be cut to service DHW			
Remote				
<b>Outputs</b>				
System Pump On	Local Pump On	DHW Pump On		
Failsafe Heating	When Boiler Running	DHW Call		

Member 3 (Space Heating Or DHW, Failsafe Space Heating and DHW W/Valves)				
<b>Settings</b>				
HeatNet Address	DHW Boiler Mode	DHW Local Pump Off	Combustion Air Damper	HeatNet Failsafe
3	Combination	No	Off	On
DHW Use Sensor	System Pump Priority			
Yes	No			
<b>Inputs</b>				
Local/Remote	OR/OVR	DHW Sensor	JPS1 Jumper must be cut to service DHW	
Remote	Jumper	Yes - Tank		
<b>Outputs</b>				
System Pump On	Local Pump On	DHW Valve On		
Failsafe Heating	When Boiler Running	DHW Call		

## DHW Method 2: Failsafe Combination DHW and Space Heating with a MASTER Boiler and Member Boilers Utilizing Pumps (Master Type: Combination)

**Figure 29** In this example the Master is not a DHW boiler.



### DHW METHOD 2: Failsafe Combination DHW and Space Heating using a MASTER Boiler and Member boilers with pumps

In this method the Master simultaneously controls both space heating and DHW heating. The Master is piped to only service space heating, and both members are piped to service space heating and DHW heating demands. The Master's *Heat Demand* input enables space heating by energizing the system pump and maintaining the Heating Setpoint at the System Header Sensor. The Master's **OR OVR** input enables the DHW heating, by maintaining the DHW Setpoint at the DHW Sensor located in the DHW tank.

Boilers are staged to meet both the Space Heating Setpoint, and the DHW Setpoint based on their runtime. When a boiler is fired to service a space heating demand it will enable its local pump, and when a boiler is fired to service a DHW demand it will enable its DHW pump. The Master modulates the boilers in order to maintain the setpoints.

This method allows for a Member boiler to provide **Failsafe** mechanisms in the event the Master fails and stops communicating to the Members. Member 2 is configured to provide failsafe space heating, and Member 3 is configured to provide both failsafe space heating and failsafe DHW heating.

**Figure 30** DHW Method 2 W/Pumps **Quick Start** Settings

## DHW METHOD 2: Combination DHW and Space Heating Using a MASTER Boiler and Member Boiler(s) Utilizing DHW Pumps

Master (Space Heating Only W/Pumps)				
<b>Settings</b>				
<b>Master Type</b>	<b>HeatNet Address</b>	<b>DHW Use Sensor</b>	<b>Combustion Air Damper</b>	
Combination	Automatic	Yes	Off	
<b>Inputs</b>				
<b>Local/Remote</b>	<b>OR/OVR</b>	<b>Header Sensor</b>	<b>System Return</b>	<b>DHW Sensor</b>
Local	Jumper	Yes	Optional	Yes - Tank
<b>Outputs</b>				
<b>System Pump On</b>	<b>Local Pump</b>			
When Boiler Enabled	When Boiler Running			

Member 2 (Space Heating Or DHW, Failsafe Space Heating W/Pumps)				
<b>Settings</b>				
<b>HeatNet Address</b>	<b>DHW Boiler Mode</b>	<b>DHW Local Pump Off</b>	<b>Combustion Air Damper</b>	<b>HeatNet Failsafe</b>
2	Combination	Yes	Off	On
<b>Inputs</b>				
<b>Local/Remote</b>	JPS1 Jumper must be cut to service DHW			
Remote				
<b>Outputs</b>				
<b>System Pump On</b>	<b>Local Pump On</b>	<b>DHW Pump On</b>		
Failsafe Heating	When Boiler Running	DHW Call		

Member 3 (Space Heating Or DHW, Failsafe Space Heating and DHW W/Pumps)				
<b>Settings</b>				
<b>HeatNet Address</b>	<b>DHW Boiler Mode</b>	<b>DHW Local Pump Off</b>	<b>Combustion Air Damper</b>	
3	Combination	Yes	Off	
<b>HeatNet Failsafe</b>	<b>DHW Use Sensor</b>	<b>System Pump Priority</b>		
On	Yes	Yes		
<b>Inputs</b>				
<b>Local/Remote</b>	<b>OR/OVR</b>	<b>DHW Sensor</b>	JPS1 Jumper must be cut to service DHW	
Remote	Jumper	Yes - Tank		
<b>Outputs</b>				
<b>System Pump On</b>	<b>Local Pump On</b>	<b>DHW Pump On</b>		
Failsafe Heating	When Boiler Running	DHW Call		



This Method highlights the flexibility of the HeatNet system. It works much the same as DHW METHOD 1, but also has the ability to provide space heating and failsafe functions. With a three boiler system, and with any one boiler down, the system can still provide space heating and a DHW call seamlessly.

With this method the Master boiler will use two PID controls to simultaneously maintain the DHW and space heating setpoints. This method is determined by **SETTINGS: DISTRIBUTED CONTROL: MASTER TYPE: Combination.**

This method utilizes a 10k thermistor connected to the DHW Sensor input and the HEADER sensor input of a MASTER boiler. Setting up the DHW portion of this method is done via the menus in: **SETTINGS: DOMESTIC HOT WATER.** For information on setting up the space heating portion of this method, Refer to **Heat Demand Control Method 1** located in the CONTROL METHODS section.

When this method is used (due to use of the DHW sensor), the OR OVR input functions as an enable/disable. This allows the DHW heating function to be enabled or disabled much in the same way as the Heat Demand input for space heating.

The DHW pump is individually controlled on each boiler that fires in DHW. The Master does not use its pump globally when any DHW boiler is called. The Master only engages its DHW pump if it was called to perform DHW heating.

When using this method, a DHW band is also available in the Home screen. The space heating band will be displayed on the left and the DHW Heating band on the right. The bands will operate in a split screen view.

When using MASTER TYPE: **COMBINATION**, the Master may control DHW and Space Heating needs. If the Master goes down or loses communication with the Member, a Failsafe mode is available to provide temporary heat.

The DHW Failsafe mode is active when a Member boiler's **SETTINGS: FAILSAFE MODES: H-NET COMMUNICATIONS LOST:** is set to **ON**. When this is set to on, normal DHW heating using the OR OVR or DHW sensor is disabled, even though there may be a DHW call on one of these inputs.

When the Master Boiler's communication is lost, and after 10 minutes of not being restored, the DHW inputs become active. The boiler now enters a stand-alone mode. The Heat Demand on that boiler becomes active and not only runs to provide failsafe space heating, but DHW heat as well. The STATUS screen will display H-NET LOST.

If a thermostat is used, the boiler will run to Method 5A until the thermostat input removes the DHW call. If a DHW temperature sensor is used, the boiler will modulate to maintain tank temperature. The DHW Call always has priority over space heating. A dual 10k sensor is available that can be wired from one tank to two boilers.

The DHW Method 2 examples uses (3) boilers. The Master controls the Space and Domestic needs, though it is not a DHW boiler. Failsafe control is provided by wiring the Member boiler to the tank sensor (dual sensor is optional) and any other system control needs the Member may require in its backup role. Then one of the local DHW control methods can be used to implement DHW heating.

One advantage to this configuration is that a BMS can control the system through the Master. It can also monitor system status through a central location (Master boiler) by a BMS, or HeatNet Online. This failsafe method can also be used in the **Combination DHW/Space Heating Simplified Drawing.**

Set up the Master boiler first:

1. Connect a 10k thermistor from the DHW tank's sensor well to J10B terminals on the MASTER, and connect a Header Sensor to the SYSTEM HEADER input. Wire any pump or valve from the DHW Pump relay's (normally open) contact to control flow of the heating water into the tank's coil or DHW loop.
2. Now, set the **SETTINGS: DISTRIBUTED CONTROL: MASTER TYPE:** to **Combination**. This setting informs the HeatNet control that (2) PIDs are to be used to control DHW and space heating.
3. There are two **MODULAR BOILER** menus, one for space heating and one for DHW heating. These (2) menus appear when the **SETTINGS: DISTRIBUTED CONTROL: MASTER TYPE** is set to **Combination**. The (2) Modular boiler settings are located in the **SETTINGS: MODULAR BOILER:** menu. Normally, there is only one, but with (2) independent PIDs, the (2) heating setpoints may behave differently due to their loads or for other various reasons. These allow for separate **ADD, SHED, MODULATE DELAY TIME,** and **MODULATION MAXIMUM** settings for DHW and space heating.
4. Next, enter the **SETTINGS: DOMESTIC HOT WATER** menu. When prompted for **BOILER MODE** enter **OFF**.
5. Change the **DHW SETPOINT** to the desired target temperature of the water in the tank/ or DHW loop. Once the control determines there is a call for DHW heat, the DHW PID will target this SETPOINT.

6. Now, change the **LOWER BAND** to the desired temperature (DHW SETPOINT – LOWER BAND) below which boilers are to be added. This setting corresponds to the minimum water temperature required in the tank. DHW heating will be initiated by starting boilers when the DHW tank's water temperature is below the temperature (DHW SETPOINT – LOWER BAND).
7. Next, change the **UPPER BAND** to the desired temperature (DHW SETPOINT + UPPER BAND) above which boilers are to be shed. This setting is the maximum tank temperature. Setting the SHED BOILER DELAY TIME correctly will limit the maximum tank temperature to the (DHW SETPOINT + UPPER BAND). Setting the SHED BOILER DELAY TIME = 0 will shut off all boilers immediately once the (DHW SETPOINT + UPPER BAND) is exceeded.
8. Change the DHW priority menu item **PUMP PRIORITY**. Setting this value to **YES** will turn OFF the system pump when the DHW mode is active. Setting this value to **NO** leaves the system pump on. This time includes the DHW post purge of the DHW pump/valve.
9. Go to the **POST PURGE** menu item. This is the time that the DHW pump relay remains energized after the DHW SETPOINT has been satisfied. Once the tank has exceeded the DHW SETPOINT + UPPER BAND temperature and this DHW boiler has shut off (DHW SHED BOILER DELAY TIME), the post purge time will begin.
10. Now, go to **USE SENSOR** Select **YES**. This will allow the boiler to control the tank or DHW loop temperature using the DHW sensor. The upper and lower band temperatures will also be loaded when set to YES.
11. The next menu is the **SHARING** menu. Sharing determines what happens when a DHW boiler is needed and none are available (all boilers are running is space heating and DHW heating). This means the Master needs to steal a space heating boiler that is running or no more boilers can fire in DHW.
 

**OFF** Is first come first serve. If a Boiler is not available because all boilers are firing, the DHW firing algorithm waits until one becomes available, even though at least one is running as a space heating boiler. If a space heating boiler is needed, a DHW running boiler cannot be stolen for space heating. **Space heating has priority when DHW is trying to steal.**

**CYCLE** The DHW algorithm can steal a space heating boiler and fire it as a DHW boiler. The space heating boiler **stops** and then restarts as a DHW boiler. **DHW has priority.**

**NO CYCLE** The DHW algorithm can steal a boiler that is already running as a space heating boiler. Instead of shutting down the space heating boiler, it does a hot swap, engaging the DHW pump and leaving the local pump running or shutting it off. Use this in conjunction with the **LOCAL PUMP OFF:** and the **LOCAL DELAY:** settings. **DHW has priority.**
12. Next is the **LOCAL PUMP OFF** menu. When a DHW heating cycle begins, what to do with the local pump/valve is determined:
 

**NO** The local pump/valve will remain running during DHW heating.

**YES** The local pump will shut off with a delay determined by **LOCAL DELAY: seconds**. This allows the DHW pump/valve to prove before shutting off the local pump.

**Piping of the system will determine which setting to use.**
13. Go to the **PURGE TO** menu. After a DHW cycle completes, the pump/valve can be selected to either purge to the **TANK**, or to the **SPACE** for the duration of the post purge time. This selection can use the space to dump the heat from the boiler and not overheat the DHW tank/load.
14. Set the **HYB SENSOR = OFF**. This sensor is selectable for Method 5A only.
15. Finally, go to the **BOILER MODE** menu. If JPS1 has not been cut, the selection will appear grayed out. Cut JPS1. Once this is done, set the **BOILER MODE** to **Combination**. The MASTER boiler will control the temperature in the tank using as many boilers as it has available on H-Net along with any the space heating needs. The boilers must be piped appropriately for this method to function correctly.
 

Now set up the Member boiler(s).

**BOILER MODE** Set to **Combination** on MEMBER boilers, only the MASTER boiler.

**DHW SETPOINT** This does not need to be set on MEMBER boilers, only the MASTER boiler.

**LOWER BAND** This does not need to be set on MEMBER boilers, only the MASTER boiler.

**UPPER BAND** This does not need to be set on MEMBER boilers, only the MASTER boiler.

**PUMP PRIORITY** This does not need to be set on MEMBER boilers, only the MASTER boiler.

**POST PURGE** This needs to be set on all boilers. All boilers control their respective DHW pump/valve when they are called to perform DHW heating.

**SHARING** This can be set on any boiler and will how boilers will cycle on/off when they are called to perform DHW Heating.

**LOCAL PUMP OFF** This can be set on any boiler to determine how the local pump/valve behaves when called to perform DHW heating.

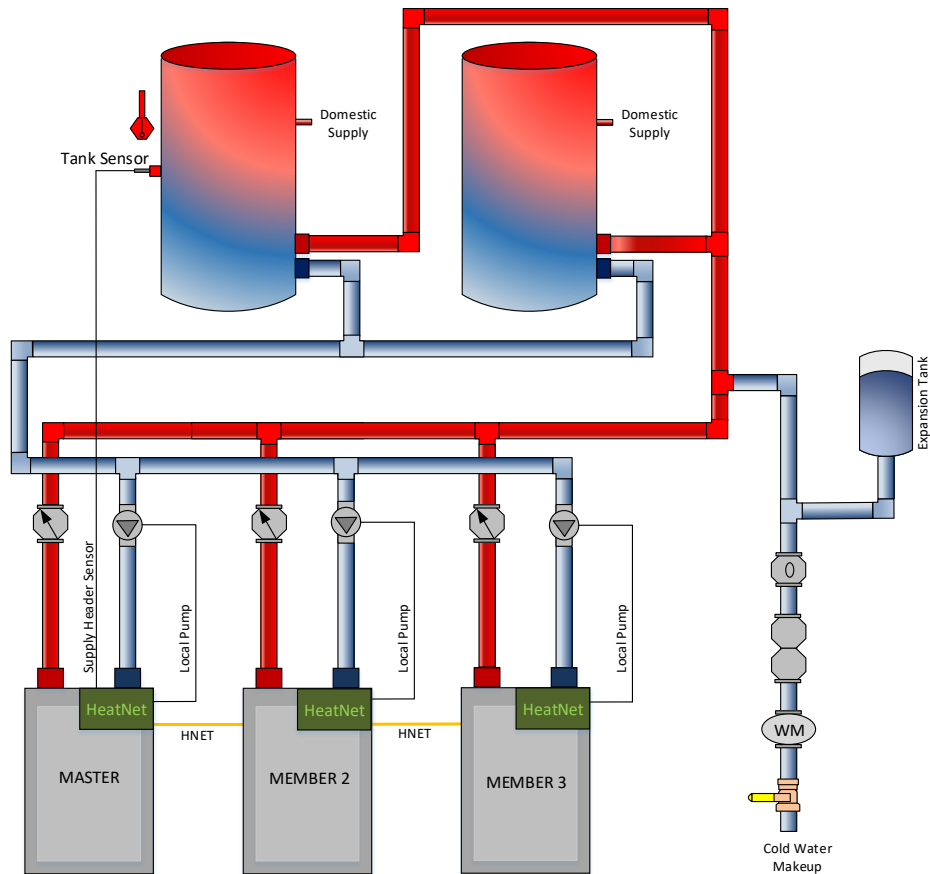
**PURGE TO** This does not need to be set on MEMBER boilers, only the MASTER boiler.

**HYB SENSOR: = OFF.** This sensor is selectable for Method 5A only.

**NOTE: JPS1 MUST be cut on all boilers providing DHW. Cutting JPS1 limits to maximum temperatures to 200F.**

## DHW Method 3: DHW Heating Only, Using a Header Sensor Input

Figure 31 Example: DHW Only Using Header Sensor, Primary/Secondary – Method 3



### DHW METHOD 3: DHW Heating ONLY using a Header sensor input, Multiple Boilers, Reverse Return.

In this method a Heating Setpoint is maintained at the Master's System Header Sensor located in the DHW tank. The Master's *Heat Demand* input enables space heating and maintains the Heating Setpoint at the System Header Sensor. Boilers are staged to meet the setpoint in the DHW tank based on their runtime, and each boiler will enable its local pump when it is running. The Master modulates the boilers to maintain the Heating Setpoint at the header sensor located in the DHW tank.

**Figure 32** DHW Method 3 *Quick Start* Settings

**DHW METHOD 3: DHW Heating ONLY Using a MASTER and Member boiler(s) Employing H-Net Space Heating PID.**

Master		
<b>Settings</b>		
<b>Master Type</b>	<b>HeatNet Address</b>	<b>Combustion Air Damper</b>
Automatic	Automatic	Off
<b>Inputs</b>		
<b>Local/Remote</b>	<b>Header Sensor</b>	JPS1 Jumper must be cut to service DHW
Local	Yes - Tank	
<b>Outputs</b>		
<b>Local Pump On</b>		
When Boiler Running		

Member 2	
<b>Settings</b>	
<b>HeatNet Address</b>	<b>Combustion Air Damper</b>
2	Off
<b>Inputs</b>	
<b>Local/Remote</b>	JPS1 Jumper must be cut to service DHW
Remote	
<b>Outputs</b>	
<b>Local Pump/Valve On</b>	
When Boiler Running	

Member 3	
<b>Settings</b>	
<b>HeatNet Address</b>	<b>Combustion Air Damper</b>
3	Off
<b>Inputs</b>	
<b>Local/Remote</b>	JPS1 Jumper must be cut to service DHW
Remote	
<b>Outputs</b>	
<b>Local Pump/Valve On</b>	
When Boiler Running	

This method will control a tank temperature when the tank temperature setpoint needs to be maintained for extended periods with minimal cycling. Multiple boilers can be used via the H-Net, as this method employs the same PID algorithm as for space heating. **SETTINGS:**

**DISTRIBUTED CONTROL: MASTER TYPE: AUTO.**

1. JPS1 must be cut on all boilers providing DHW to ensure the maximum output temperature of all boilers is limited to 200F for DHW operation.

This Method is very similar to the DHW only method, but:

- A. The display will not indicate that it is a DHW heating boiler.
  - B. The DHW Heating band will also not be displayed.
  - C. The heating band will use the space heating band and not the UPPER and LOWER DHW heating band limits.
  - D. DHW settings are not used.
  - E. Set the **SETTINGS: DISTRIBUTED CONTROL: MASTER TYPE:** to **AUTO.**
  - F. This method is for backwards compatibility.
2. Use the **Heat Demand Control Method 1** located in the CONTROL METHODS section on page 22. Instead of placing the Header sensor in the Header pipe, place it in a well, in the tank, or a DHW loop.

The temperature at which boilers are staged **ON**, and then **OFF** is controlled by the

**SETTINGS: SETPOINTS: HEAT BAND** differential. This can be understood by referring to the INTRODUCTION section on the MASTER in the beginning of this manual.

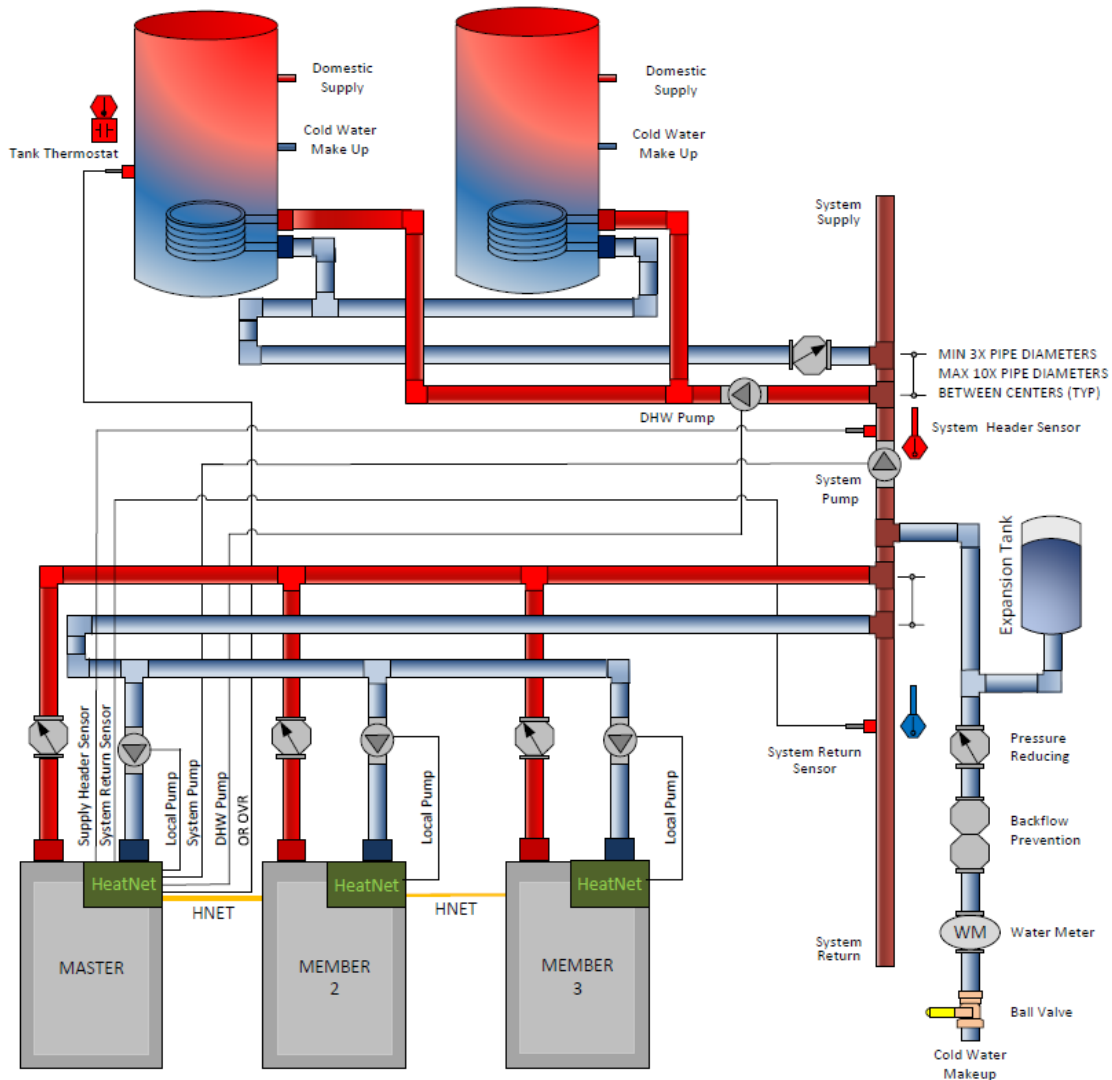
This differential has the added effect of heating the tank above the tank's setpoint temperature. If the tank setpoint is set to 140F and the heat band is set to 10F, then the tank temperature will rise to 145F before the first boiler turns off (setpoint = 140F +/- heat band/2). With (2) boilers running, the **SHED BOILER DELAY** time could add to the tank temperature. So, to ensure that all boilers are shut off at the upper point of the heat band, set the **SHED BOILER DELAY time to 0 or other small value.** This will effectively turn off all boilers at the upper heat band point of: (example) 145F.

Now, there is one more thing to consider, the pump's post purge time. Dumping the heat from all boilers (that were running) using a pump post purge cycle will have an effect on the tank's water temperature. Consider this when establishing the local pump's **POST PURGE TIME.**

3. Connect the Local Pump relay contact on J13 to enable the DHW pump. Set its post purge time to dump the boiler's heat into the tank when the boiler shuts off. **Be aware that this may heat the tank above the upper heat band of the setpoint temperature.**
4. Enable the system by placing the LOCAL/REMOTE switch on the Master to the LOCAL position.

## DHW Method 4a: Space Heating with DHW Override of Setpoint on Master, using an Aquastat

**Figure 33** Example: DHW METHOD 4a Space Heating with DHW Override of Setpoint on Master, using an Aquastat, Primary Secondary, Reverse Return



### DHW METHOD 4a: Space Heating with DHW Override of Setpoint on Master, using an Aquastat, Primary Secondary, Reverse Return

In DHW METHOD 4a, the Master's *Heat Demand* input enables space heating by energizing the system pump and maintaining the Heating Setpoint at the Master's System Header Sensor. When the Aquastat located in the DHW tank calls for heat, the system loop temperature is overridden with the DHW Setpoint. The system pump continues to run, and the DHW pump is enabled to supply heat to the tanks until the Aquastat is satisfied.

Boilers are staged to meet the active setpoint based on their runtime, and each boiler will enable its local pump when it is running. The Master modulates the boilers in order to maintain the active setpoint.

**Figure 34** DHW Method 2 W/Valves **Quick Start** Settings

**DHW METHOD 4a: Space Heating with DHW Override of Setpoint on Master Using an Aquastat**

Master				
<b>Settings</b>				
<b>Master Type</b>	<b>HeatNet Address</b>	<b>Combustion Air Damper</b>		
Combination	Automatic	Off		
<b>Inputs</b>				
<b>Local/Remote</b>	<b>OR OVR</b>	<b>Header Sensor</b>	<b>System Return</b>	JPS1 Jumper must be cut to service DHW
Local	Tank Aquastat	Yes	Optional	
<b>Outputs</b>				
<b>System Pump On</b>	<b>Local Pump On</b>	<b>DHW Pump On</b>		
When Boiler Enabled	When Boiler Running	DHW Call		

Member 2	
<b>Settings</b>	
<b>HeatNet Address</b>	<b>Combustion Air Damper</b>
2	Off
<b>Inputs</b>	
<b>Local/Remote</b>	JPS1 Jumper must be cut to service DHW
Remote	
<b>Outputs</b>	
<b>Local Pump On</b>	
When Boiler Running	

Member 3	
<b>Settings</b>	
<b>HeatNet Address</b>	<b>Combustion Air Damper</b>
3	Off
<b>Inputs</b>	
<b>Local/Remote</b>	JPS1 Jumper must be cut to service DHW
Remote	
<b>Outputs</b>	
<b>Local Pump On</b>	
When Boiler Running	



This method is for controlling DHW utilizing a tank thermostat connected to a Master boiler. This method requires a thermostat input to the OR OVR. When the thermostat contact closes across the input **OR OVR (J12A .7 & .8)**, the control will sense this closure and override the space heating setpoint with the DHW setpoint. **SETTINGS: DISTRIBUTED CONTROL: MASTER TYPE: AUTO.**

This method is for backwards compatibility.

In this mode, the boiler will fire to the **DHW** setpoint. The settings for space heating will be used except for the addition of controlling the DHW pump/valve by the Master boiler.

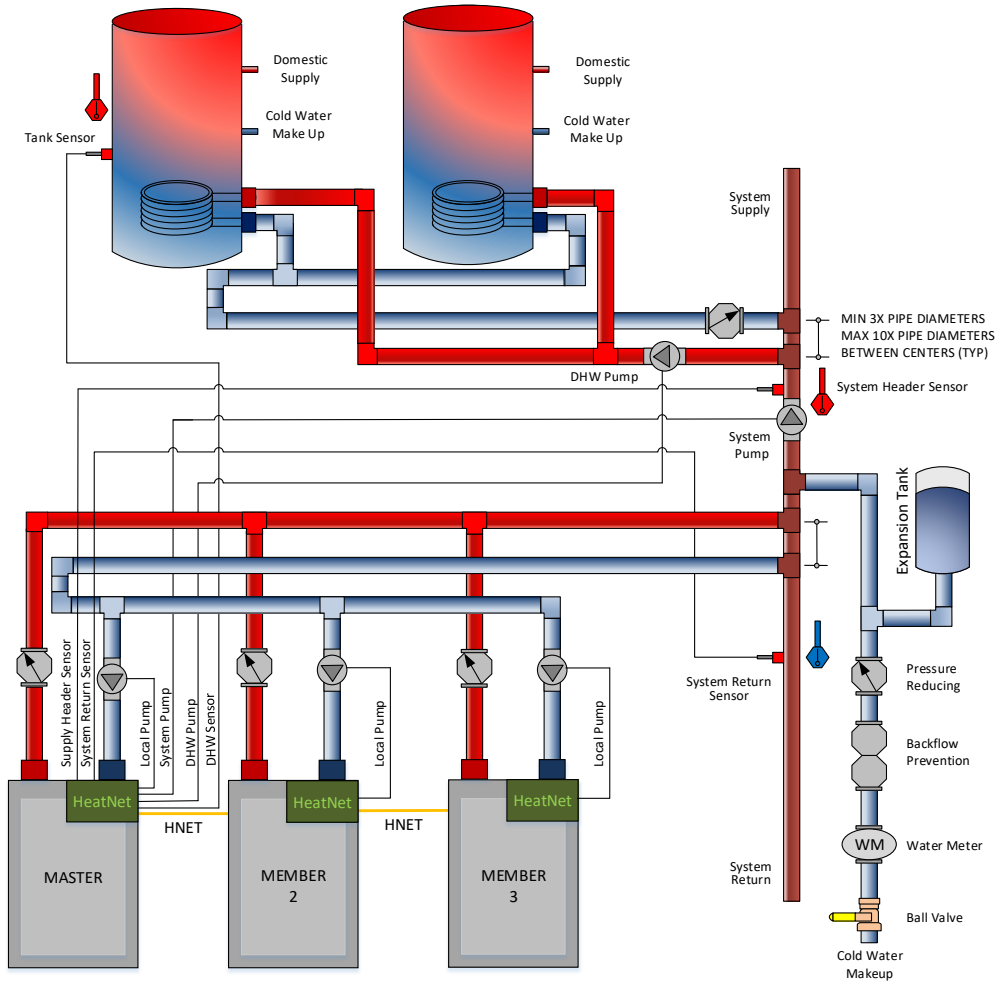
1. Wire the dry contact from the thermostat on the tank to the input on J12A terminal 7 & 8 (**OR OVR**). Also, at this time wire any pump or valve from the DHW Pump relay (normally open) contact (J13 terminals 16, 17, & 18) of the Master to control flow of the heating water into the tank's coil.
2. Enter the **DOMESTIC HOT WATER MENU**. Go to **BOILER MODE** and enter **OFF/AUTO**.
3. **DHW SETPOINT** The setpoint should reflect the temperature desired in the heating loop when a tank is calling for DHW heat.
4. **LOWER BAND** This is not used.
5. **UPPER BAND** This is not used.
6. **PUMP PRIORITY** Setting this value to **YES** will turn OFF the system pump when the DHW setpoint override mode is active. Setting this value to **NO** leaves the system pump on. This active period includes the post purge of the DHW pump/valve.
7. Select the menu item **POST PURGE**. This is the time that the DHW pump relay remains energized after the DHW thermostat has been satisfied. Once the tank has opened its thermostat, the system/local setpoint will be reloaded and the post purge time will begin.
8. Select the menu item: **LOCAL PUMP OFF**: When a DHW heating cycle begins, what to do with the local pump/valve is determined:
  - NO** The local pump/valve will remain running during DHW heating.
  - YES** The local pump will shut off with a delay determined by **LOCAL DELAY: seconds**. This allows the DHW pump/valve to prove before shutting off the local pump.

**Piping of the system will determine which setting to use.**
9. Select the menu item: **PURGE TO**. After a DHW cycle completes, the pump/valve can be selected to either purge to the **TANK**, or to the **SPACE** for the duration of the post purge time. This selection can use the space to dump the heat from the boiler and not overheat the DHW tank/load.
10. Set the **HYB SENSOR = OFF**. This sensor is selectable for Method 5A only.
 

Follow the same steps as used to program DHW Heating using a Header Sensor INPUT. **USE SENSOR**, select **NO**.

## DHW Method 4b: Space Heating with DHW Override of Setpoint on Master, using a DHW 10K Tank Sensor

**Figure 35** Example: DHW Method 4b: Space Heating with DHW Override of Setpoint on Master, using a DHW Sensor, Primary Secondary, Reverse Return.



### DHW METHOD 4b: Space Heating with DHW Override of Setpoint on Master, using a DHW Sensor, Primary Secondary, Reverse Return

In DHW METHOD 4b, the Master’s *Heat Demand* input enables space heating by energizing the system pump and maintaining the Heating Setpoint at the Master’s System Header Sensor. The Master’s *OR OVR* input is jumped to enable DHW heating using the DHW tank sensor. When the DHW tank temperature drops, a DHW heat demand is generated, and the system loop temperature is overridden with the DHW Setpoint. The system pump continues to run, and the DHW pump is enabled to supply heat to the tanks until the DHW tank is satisfied.

Boilers are staged to meet the active setpoint based on their runtime, and each boiler will enable its local pump when it is running. The Master modulates the boilers in order to maintain the active setpoint.

**Figure 36** DHW Method 4b *Quick Start* Settings

**DHW METHOD 4b: Space Heating with DHW Override of Setpoint on Master Using a 10K Tank Sensor**

Master					
<i>Settings</i>					
<b>Master Type</b>	<b>HeatNet Address</b>	<b>DHW Use Sensor</b>	<b>Combustion Air Damper</b>		
Combination	Automatic	Yes	Off		
<i>Inputs</i>					
<b>Local/Remote</b>	<b>OR OVR</b>	<b>Header Sensor</b>	<b>System Return</b>	<b>DHW Sensor</b>	<b>JPS1 Jumper must be cut to service DHW</b>
Local	Jumper	Yes	Optional	Yes - Tank	
<i>Outputs</i>					
<b>System Pump On</b>	<b>Local Pump/Valve On</b>	<b>DHW Pump On</b>			
When Boiler Enabled	When Boiler Running	DHW Call			

Member 2	
<i>Settings</i>	
<b>HeatNet Address</b>	<b>Combustion Air Damper</b>
2	Off
<i>Inputs</i>	
<b>Local/Remote</b>	<b>JPS1 Jumper must be cut to service DHW</b>
Remote	
<i>Outputs</i>	
<b>Local Pump On</b>	
When Boiler Running	

Member 3	
<i>Settings</i>	
<b>HeatNet Address</b>	<b>Combustion Air Damper</b>
3	Off
<i>Inputs</i>	
<b>Local/Remote</b>	<b>JPS1 Jumper must be cut to service DHW</b>
Remote	
<i>Outputs</i>	
<b>Local Pump On</b>	
When Boiler Running	

This method is for controlling DHW utilizing a 10k sensor in the tank connected to **DHW TANK (J10A, 9 & 10)** of a Master boiler. This method is only available on the Master boiler since its purpose is to override the setpoint. This method requires a jumper input to the **OR OVR (J12A 7 & 8)**, which acts like an enable. The control will sense this closure and override the space heating setpoint with the DHW setpoint when the DHW tank temperature drops below the lower band of the DHW setpoint. All boilers are started and stopped using the space heating “Modular Boiler” settings. **SETTINGS: DISTRIBUTED CONTROL: MASTER TYPE: AUTO.**

In this mode, the boiler will fire to the **DHW** setpoint. The settings for space heating will be used except for the addition of the **Master Boiler controlling the DHW pump/valve.**

1. Wire the 10K Tank sensor to the Master on **DHW TANK (J10A, 9 & 10)**. Jumper the input on **J12A terminal 7 & 8 (OR OVR)**. Also, at this time wire any pump or valve from the DHW Pump relay contact (**J13 terminals 16, 17, & 18**) **N/C, C, & N/O respectfully** to control flow of the heating water into the tank’s coil.
2. Enter the **DOMESTIC HOT WATER MENU**. Go to **BOILER MODE** and enter **OFF/AUTO**.
3. **DHW SETPOINT** The setpoint should reflect the temperature desired in the heating loop when a tank is calling for DHW heat.
4. **LOWER BAND** This is not used.

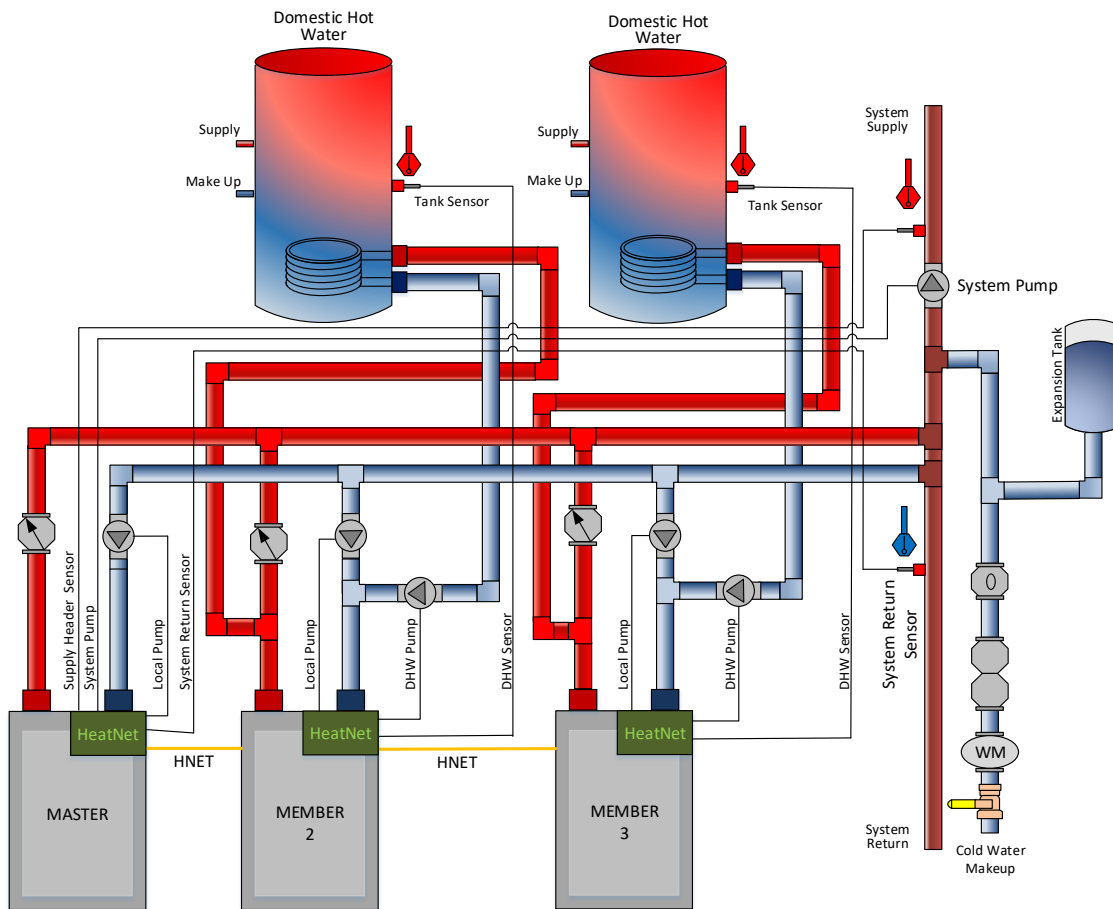
5. **UPPER BAND** This is not used.
6. **PUMP PRIORITY** Setting this value to **YES** will turn **OFF** the system pump when the DHW setpoint override mode is active. Setting this value to **NO** leaves the system pump on. This active period includes the post purge of the DHW pump/valve.
7. Select the menu item **POST PURGE**. This is the time that the DHW pump relay remains energized after the DHW demand has been satisfied. Once the tank has reached temperature, the system/local setpoint will be reloaded and the post purge time will begin.
8. Select the menu item: **LOCAL PUMP OFF**: When a DHW heating cycle begins, what to do with the local pump/valve is determined:
  - NO** The local pump/valve will remain running during DHW heating.
  - YES** The local pump will shut off with a delay determined by **LOCAL DELAY: seconds**. This allows the DHW pump/valve to prove before shutting off the local pump.

**Piping of the system will determine which setting to use.**
9. Select the menu item: **PURGE TO**. After a DHW cycle completes, the pump/valve can be selected to either purge to the **TANK**, or to the **SPACE** for the duration of the post purge time. This selection can use the space to dump the heat from the boiler and not overheat the DHW tank/load.
10. Set the **HYB SENSOR = OFF**. This sensor is selectable for Method 5A only.

Follow the same steps as used to program DHW Heating using a Header Sensor INPUT. **USE SENSOR**, select **Yes**.

## DHW Method 5a: Local DHW Tank Heating using a 10k Tank Sensor.

Figure 37 Example: DHW Heating to a Local Boiler's Tank, – Method 5a



### DHW METHOD 5a: Local DHW Tank Heating Override using a 10K Type II Tank Sensor.

In DHW METHOD 5a: Local DHW Tank Heating Override, the Master's *Heat Demand* input enables space heating by energizing the system pump and maintaining the Heating Setpoint at the Master's System Header Sensor using the available members. A Member boiler will enable its local pump when called to service a heating call by the Master. Each member has its *OR OVR* input jumped to enable local DHW heating using its DHW Sensor. When a DHW tank sensor calls for heat, the local boiler goes offline from the Master. The boiler then disables its local pump, and enables its DHW pump to service the local tank until the tank sensor has been satisfied. Once the call for DHW heat has been satisfied, the boiler is placed back online for the Master to service the main heating loop.

**Figure 38** DHW Method 5a *Quick Start* Settings

**DHW METHOD 5a: Local Tank Heating Using a DHW Tank Sensor**

Master		
<b>Settings</b>		
<b>Master Type</b>	<b>HeatNet Address</b>	<b>Combustion Air Damper</b>
Automatic	Automatic	Off
<b>Inputs</b>		
<b>Local/Remote</b>	<b>Header Sensor</b>	<b>System Return</b>
Local	Yes	Optional
<b>Outputs</b>		
<b>System Pump On</b>	<b>Local Pump On</b>	
When Boiler Enabled	When Boiler Running	

Member 2				
<b>Settings</b>				
<b>HeatNet Address</b>	<b>DHW Boiler Mode</b>	<b>DHW Use Sensor</b>	<b>DHW Local Pump Off</b>	<b>Combustion Air Damper</b>
2	Local	Yes	Yes	Off
<b>Inputs</b>				
<b>Local/Remote</b>	<b>OR OVR</b>	<b>DHW Sensor</b>	<b>JPS1 Jumper must be cut to service DHW</b>	
Remote	Jumper	Yes - Tank		
<b>Outputs</b>				
<b>Local Pump On</b>	<b>DHW Pump On</b>			
Space Heating Call	DHW Call			

Member 3				
<b>Settings</b>				
<b>HeatNet Address</b>	<b>DHW Boiler Mode</b>	<b>DHW Use Sensor</b>	<b>DHW Local Pump Off</b>	<b>Combustion Air Damper</b>
3	Local	Yes	Yes	Off
<b>Inputs</b>				
<b>Local/Remote</b>	<b>OR OVR</b>	<b>DHW Sensor</b>	<b>JPS1 Jumper must be cut to service DHW</b>	
Remote	Jumper	Yes - Tank		
<b>Outputs</b>				
<b>Local Pump On</b>	<b>DHW Pump On</b>			
Space Heating Call	DHW Call			

This method is used to provide combination space heating and DHW heating. The boiler may be stand alone or in a HeatNet configuration. It is meant to fire an individual boiler in a DHW heating priority mode when that boiler's local tank temperature has a call for DHW heat (tank sensor's temperature drops below the DHW Setpoint + LOWER BAND). The boiler will stop space heating (if running) and switch to DHW heating. The DHW pump/valve will be engaged and the water temperature in the tank will be maintained by the boiler at the DHW setpoint. Once the tank temperature exceeds the Setpoint + UPPER BAND temperature, DHW heating will stop and the pump/valve's post purge will start.

When a tank's temperature sensor is connected directly to a boiler and the **BOILER MODE** is set to **LOCAL**. The boiler will go offline from HeatNet and service the DHW needs of its local tank. If the boiler is running in space heating mode, then the "SHARING" setting may be used to determine how, or if, to shut down before starting a DHW cycle. When the DHW cycle is complete (includes the post purge time of the DHW pump), the boiler will go back online with HeatNet and become available to fire.

During a DHW cycle the DHW setpoint will be loaded along with the UPPER and LOWER BAND limits. Also, the **SETTINGS: DISTRIBUTED CONTROL: MASTER TYPE:** is set to **AUTO**.

When a 10k Type II sensor is used with this method, the OR OVR input functions as an enable/disable. This allows the DHW heating function to be enabled or disabled much in the same way as the Heat Demand input for space heating.

When using this method, a DHW band is also available in the Home Screen. The space heating band will be displayed on the left and the DHW Heating band on the right. The bands will operate in a split screen view.

1. Connect a 10k thermistor from the DHW tank's sensor well to J10B terminals on any boiler. Wire a pump or valve from the DHW pump or the System pump (normally open) relay contact to control flow of the heating water into the tank's coil or system loop.

The System pump will always be enabled as long as the Heat Demand input is closed and the **SETTINGS: PUMP PRIORITY** is set to **NO**. The DHW pump will be enabled whenever there is a DHW call for heat.

A DHW call for heat is when the DHW temperature is below the (DHW SETPOINT – LOWER BAND) or when the DHW temperature is below the (DHW SETPOINT + UPPER BAND) and boilers are firing. After a DHW call for heat ends:

- A. The pump will remain on during a post purge pump cycle until the post purge timer expires.

2. Next, enter the **DOMESTIC HOT WATER** menu on the Master boiler. Go to **BOILER MODE** and enter **LOCAL**.
3. Change the **DHW SETPOINT** to the desired target temperature of the water in the tank. Once the control determines there is a call for DHW, the DHW SETPOINT is loaded and the boiler will target the setpoint.
4. Now, change the **LOWER BAND** to the desired temperature (DHW SETPOINT – LOWER DHW DIFF) below which boilers are to be added. This setting corresponds to the minimum water temperature required in the tank. DHW heating will be initiated when the DHW tank's water temperature is below the temperature (DHW SETPOINT – LOWER BAND).

How long the temperature of the tank stays below the temperature (DHW SETPOINT – LOWER BAND) is used to determine when boilers are started along with the ADD BOILER DELAY TIME.

5. Next, change the **UPPER BAND** to the desired temperature (DHW SETPOINT + UPPER BAND) above which boilers are to be shed. This setting is the maximum tank temperature. Setting the SHED BOILER DELAY TIME correctly will limit the maximum tank temperature to the (DHW SETPOINT + UPPER BAND). Setting the SHED BOILER DELAY TIME = 0 will shut off all boilers immediately once the (DHW SETPOINT + UPPER BAND) is exceeded.
6. Change the **DHW PRIORITY**. Setting this value to YES will turn OFF the system pump when the DHW mode is active (when the DHW pump is on). Setting this value to NO leaves the system pump on.
7. Now got to the **POST PURGE** menu. This is the time that the DHW pump relay remains energized after the DHW SETPOINT has been satisfied.
  - A. The pump will remain on during a post purge pump cycle until the post purge timer expires.
8. Now, go to the **USE SENSOR** menu and select **YES**. This will allow the boiler to control the local tank or DHW loop temperature using the DHW sensor. The upper and lower differential temperatures will also be loaded.
9. Got to **SHARING** and set it to **OFF** or **CYLE** if the boiler is currently running in space heating and needs to be shut down before starting up in DHW.

If **SHARING** is set to **NO CYCLE**, a hot swap will occur. A hot swap is when the boiler is running in space heating mode and does not

need to be shut down. The DHW pump will be energized without the boiler stopping. Once the DHW cycle has completed, the boiler will stop and wait to be called again for either space heating or DHW heating. A shutdown always occurs after a DHW cycle completes.

10. Set the **LOCAL PUMP OFF** value to **NO**.

This will leave the local pump on during a DHW heating cycle (backwards compatibility). Setting this value to YES will turn off or keep the local pump off.

Setting this value to **YES**, will shut the local pump off during a DHW heating cycle, but will keep the local pump on for the **LOCAL DELAY**: 10s time before shutting off. This **LOCAL DELAY**: time can be adjusted in the next menu item by pressing the down arrow again.

11. Set the **PURGE TO** value to **TANK**. This will purge the heat from the boiler into the tank or system loop. This will be done using the DHW pump after the DHW heating cycle is complete.

If the **PURGE TO**: is set to **SPACE**, once the DHW cycle has completed, the boiler will shut the DHW pump off within a few seconds. The **SPACE** setting is to be used only for mixed space and DHW heating.

**HYB SENSOR = OFF**

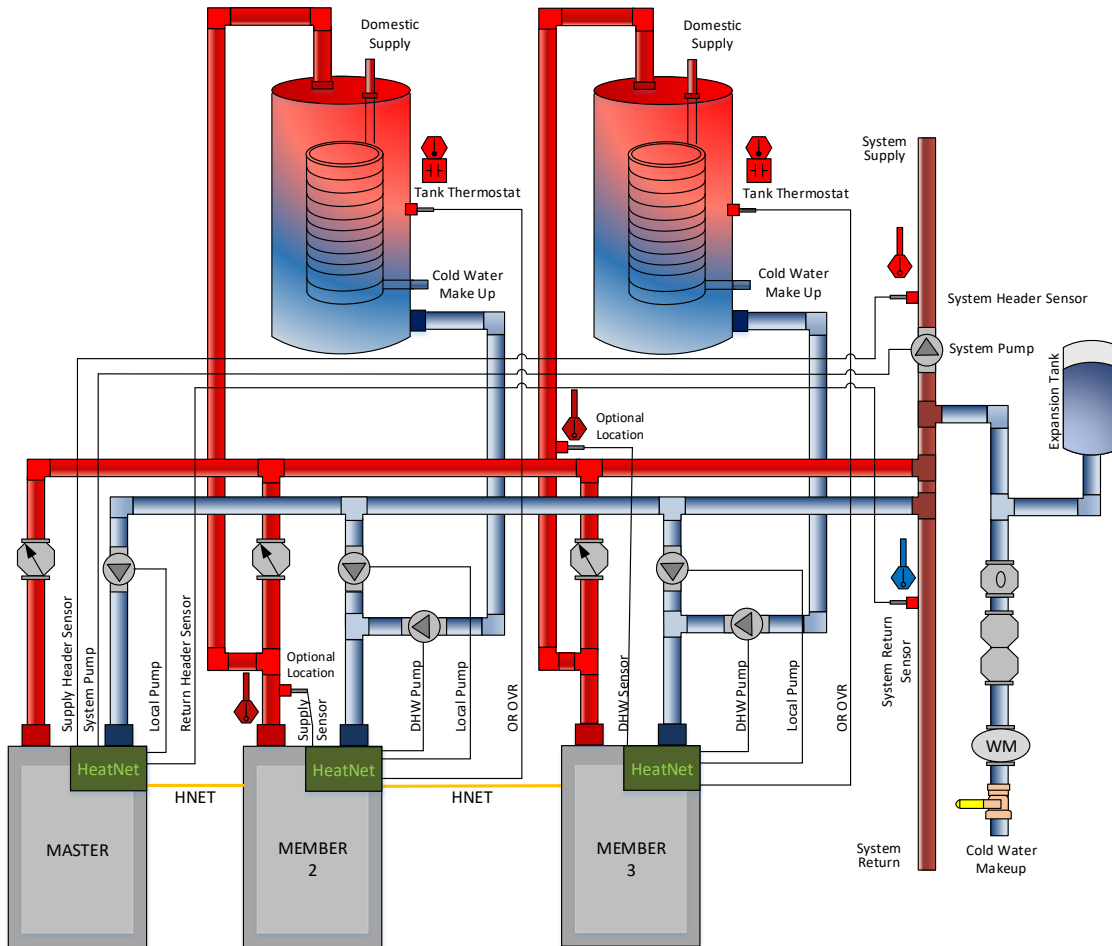
**SETTINGS: DISTRIBUTED CONTROL:**  
**MASTER TYPE** select **AUTO**,  
**DHW or COMBINATION**.

**NOTE:** JPS1 MUST be cut on all boilers providing DHW.



## DHW Method 5b: Local DHW Tank Heating using a Thermostat & Hybrid Sensor.

Figure 39 Example: DHW Heating to a Local Boiler's Tank, Movable Sensor Location – Method 5b



### DHW METHOD 5b: Local DHW Tank Heating using an aquastat and a Hybrid Sensor.

In DHW METHOD 5b: Local DHW Tank Heating using an aquastat and a Hybrid Sensor, the Master's *Heat Demand* input enables space heating by energizing the system pump and maintaining the Heating Setpoint at the Master's System Header Sensor using the available members. A Member boiler will enable its local pump when called to service a heating call by the Master.

Each member has its *OR OVR* input connected to a local tank aquastat. This method allows the DHW Temperature Sensor to be placed in many locations. This sensor is called the Hybrid Sensor. When the aquastat located in the DHW tank calls for heat, the local boiler goes offline from the Master and services the DHW call. The Member then disables its local pump, and enables its DHW pump to maintain the DHW Setpoint at the Hybrid Sensor location. Once the DHW aquastat has been satisfied, the boiler is placed back online for the Master to service the main heating loop.

Member 2 is configured to use its Local Supply sensor when servicing DHW demands, and Member 3 is configured to use its DHW sensor.

**Figure 40** DHW Method 5b *Quick Start* Settings

**DHW METHOD 5b: Local Tank Heating using a Hybrid Sensor**

Master		
<b>Settings</b>		
<b>Master Type</b>	<b>HeatNet Address</b>	<b>Combustion Air Damper</b>
Automatic	Automatic	Off
<b>Inputs</b>		
<b>Local/Remote</b>	<b>Header Sensor</b>	<b>System Return</b>
Local	Yes	Optional
<b>Outputs</b>		
<b>System Pump On</b>	<b>Local Pump On</b>	
When Boiler Enabled	When Boiler Running	

Member 2			
<b>Settings</b>			
<b>HeatNet Address</b>	<b>DHW Boiler Mode</b>	<b>Combustion Air Damper</b>	
2	Local	Off	
<b>DHW Use Sensor</b>	<b>Hybrid Sensor</b>	<b>DHW Local Pump Off</b>	
No	Supply	Yes	
<b>Inputs</b>			
<b>Local/Remote</b>	<b>OR OVR</b>	<b>JPS1 Jumper must be cut to service DHW</b>	
Remote	Tank Aquastat		
<b>Outputs</b>			
<b>Local Pump On</b>	<b>DHW Pump On</b>		
Space Heating Call	DHW Call		

Member 3			
<b>Settings</b>			
<b>HeatNet Address</b>	<b>DHW Boiler Mode</b>	<b>Combustion Air Damper</b>	
3	Local	Off	
<b>DHW Use Sensor</b>	<b>Hybrid Sensor</b>	<b>DHW Local Pump Off</b>	
No	DHW	Yes	
<b>Inputs</b>			
<b>Local/Remote</b>	<b>OR OVR</b>	<b>JPS1 Jumper must be cut to service DHW</b>	
Remote	Tank Aquastat		
<b>Outputs</b>			
<b>Local Pump On</b>	<b>DHW Pump On</b>		
Space Heating Call	DHW Call		

Method 5b can also be used in a hybrid mode on **Member** boilers with a thermostat connected to the OR OVR input. This will enable DHW heating, and be used instead of having the 10k sensor's temperature detect when DHW heating is needed, but will use a selectable sensor instead to maintain setpoint.

When the OR OVR input sees the thermostat close, the DHW pump/valve will be engaged and remain energized as long as the OR OVR input sees that the thermostat is closed. The DHW setpoint along with the DHW heating band will then be loaded. A steady temperature will now be maintained using the **HYB SENSOR** setting in the DHW menu. This sensor will control the water temperature at the sensor's location, enabling or disabling the boiler as needed until the OR OVR input sees the thermostat open. Once the thermostat opens, the DHW pump post purge will begin.

The difference between the settings of method **5a** vs. method **5b** is the "USE SENSOR" setting. **5a** requires that the "USE SENSOR" setting be set to **YES**, and the **5b** "USE SENSOR" setting be set to **NO**. The **HYBRID SENSOR** setting must also be set in the **5b** mode to the sensor where temperature needs to be maintained. It must be set to **OFF** in the **5a** method.

**Method 5a**    **USE SENSOR = YES**  
                   **HYB SENSOR = OFF**

**Method 5b**    **USE SENSOR = NO**  
                   **HYB SENSOR = SUPPLY, DHW,**  
   **RETURN**

Each sensor selection/location has its advantages. Select the:

**Supply** sensor will limit the temperature/firing rate of the boiler, but may not be sufficient for continuous demand or speed in heating the tank. It is already available, so no additional sensor is needed.

**Return** sensor will allow the boiler to run its supply temperature up quickly, but may bounce off of the operating limit band. This would heat the tank in the shortest time, but may overheat the tank. It is already available, so no additional sensor is needed.

**DHW** sensor will allow the placement anywhere needed to maintain that locations temperature. This is an additional sensor that needs to be acquired.

A thermostat can be placed in a tank and connected to the OR OVR input. (**On Member boilers only**, The Master uses OR OVR already with DHW METHOD 4), When the thermostat contact closes across the input **OR OVR (J12A .7 & .8)** on a Member boiler, the control will sense this closure and disconnect itself from HeatNet.

## DHW METHOD 6: DHW using Direct Control

If the control's **SETTINGS: 4-20 mA** input is set to **PRIORITY = HIGH** the 4-20 mA signal, once brought above the 4-20 mA starting current can be used to override any other Heat Demand and direct modulate the boiler.

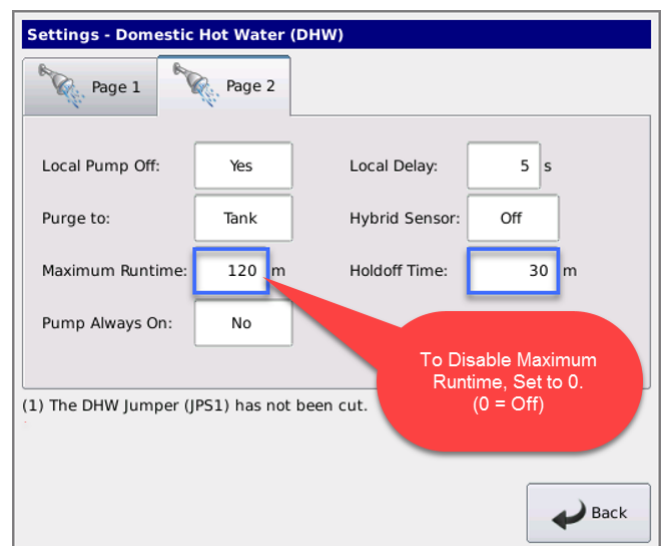
This can be set in menu: **ADVANCED SETUP: 4-20 mA INPUT**. It allows a member boiler to be taken offline and directly modulated by an external control.

If the Master is using it for heating and the **ADVANCED SETUP: 4-20 mA** is set to **PRIORITY= HIGH**, an external control can now output a 4-20 mA signal which will take over the boiler's fire rate and override all other heating demand inputs. The external control would also need to open any valves or turn on pumps. This is typically used for DHW Control.

## DHW Maximum Runtime

When a Combination system has a call for DHW heat and services it for a time that is longer then designed, the DHW may need to be locked out or held off for a predetermined amount of time (retry).

Two settings are provided to control this situation: the Maximum Runtime, and the Holdoff Time. The Maximum Runtime is set to allow the DHW call to occur for the design time of the system. If for some reason this time is exceeded, the Holdoff Time setting goes into effect. The Holdoff time can be set to a Lockout (the OR OVR input needs to toggle or a power cycle to clear the Lockout), or a fixed amount of boiler off time. If the fixed amount of Holdoff time is selected, the DHW functionality will be cycled between the boilers running for the Maximum Runtime, and stopped for the duration of the Holdoff Time.



## Base Loading, Relay Control

The control has the ability to control (1) base load boiler using the K8 Relay contacts on J4 pins 2 & 6. In order to connect to this plug, (2) wires with pins are required and inserted in J4. Base Loading via relay requires these (2) flying leads (loose wires available from the factory) to be inserted into J4, pins 2 & 6. These (2) wires then make up the Normally Open contacts. This feature also can be used on Master or Member boilers. The solid state relay K8, with contact connections on J4.2 & J4.6 has a rating of: **0.1 to 1 Amp.**

If the base load boiler is of the modulating type, a 4-20 mA signal is also provided on J4 pins 1 and 5. Jumper shunt JS1 will then need to be set to 4-20 mA position. Two additional wires (available from the factory) will need to be added to the J4 pins at 1 & 5. Pin 1 is the + output of the 4-20 mA transmitter, and pin 5 is the - output. This modulating control signal is used to modulate the base load boiler along with the HeatNet boilers in parallel. The ADAPTIVE MOD does not function in lowering the modulation rate when the base load boiler is added. The PID will adapt to the newly fired base load boiler and lower its modulation rate when the increase in water temperature is observed.

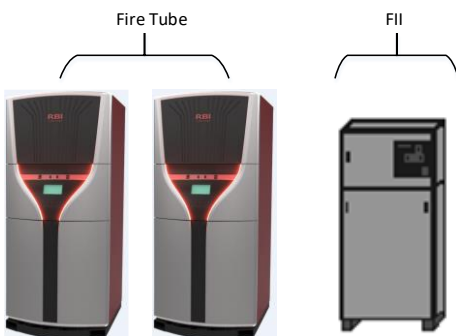
The Master boiler requires a heat demand input in order to control a Base Load boiler connected to it. Though, the Master boiler does not need to be running. This is to ensure that the system pump and damper will be enabled for the system. The System pump and Damper control are the main reasons to connect the Base Load boiler to the Master.

A Member boiler does not need to be firing in order to enable its Base Load boiler. Provisions for the Base Load boiler should be checked to allow a system pump to run and any dampers to open.

Failsafe on the Master boiler will occur if there is a Heat Demand input present, there are no available boilers to fire, and the Master has failed.

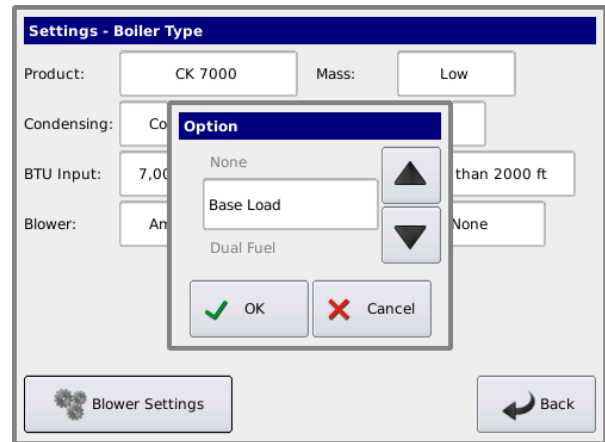
Failsafe using the Base Load boiler from the Member is automatic. Whenever the Member fails, the Base Load boiler will be enabled as long as the Member can do so.

**Figure 41** Base loading a Futera II boiler

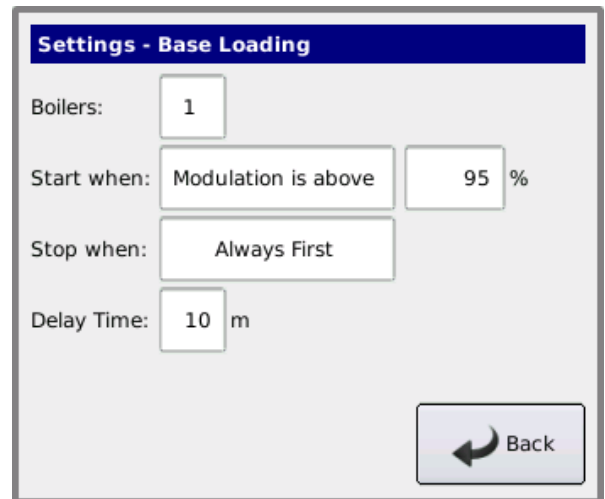


Enable the base load feature by setting:

1. **SETTINGS: BOILER TYPE: OPTION to BASE LOAD.** This setting uses the OPTION Relay K8 (J4 pins 2 & 6) as control for a Base Load Boiler.



2. The **SETTINGS: BASE LOADING: BOILERS:** to 1. Currently allows (1) base load boiler.
3. The **START WHEN: & STOP WHEN:** qualifier condition to the method discussed below.
4. The **DELAY TIME** to the amount of time required after the start qualifier condition has been met to start the boiler.



If a MINIMUM OFF time of the Base Load boiler is needed, the Base Load boiler will share the MIN OFF TIME of the boiler controlling it. If the base load boiler was running and shuts off, the MIN OFF TIME will need to expire before the boiler can start again. Once this time expires, the DELAY TIME also needs to expire to start the boiler. This will help in minimizing short cycle conditions and can be set at **SETTINGS: FIRING MODE: MIN OFF TIME.**

**Preferred:**

A modulating base load boiler that can accept a 4-20 mA control signal such as the Futera series is preferred, or a non-modulating base load boiler that is sized correctly to the If the base load boiler is not of the modulating type, stopping the Base Load boiler will require that the size of the Base Load boiler in BTUs to be known relative to the H-Net boilers.

HeatNet boilers. Boiler selection is ideally; having more total BTUs in the HeatNet boilers than total BTUs of the Base Load boiler. This will prevent short cycling. Example: (4) 2 million BTU HeatNet boilers = 8 million BTUs and (1) 6 million BTU Base Load boiler.

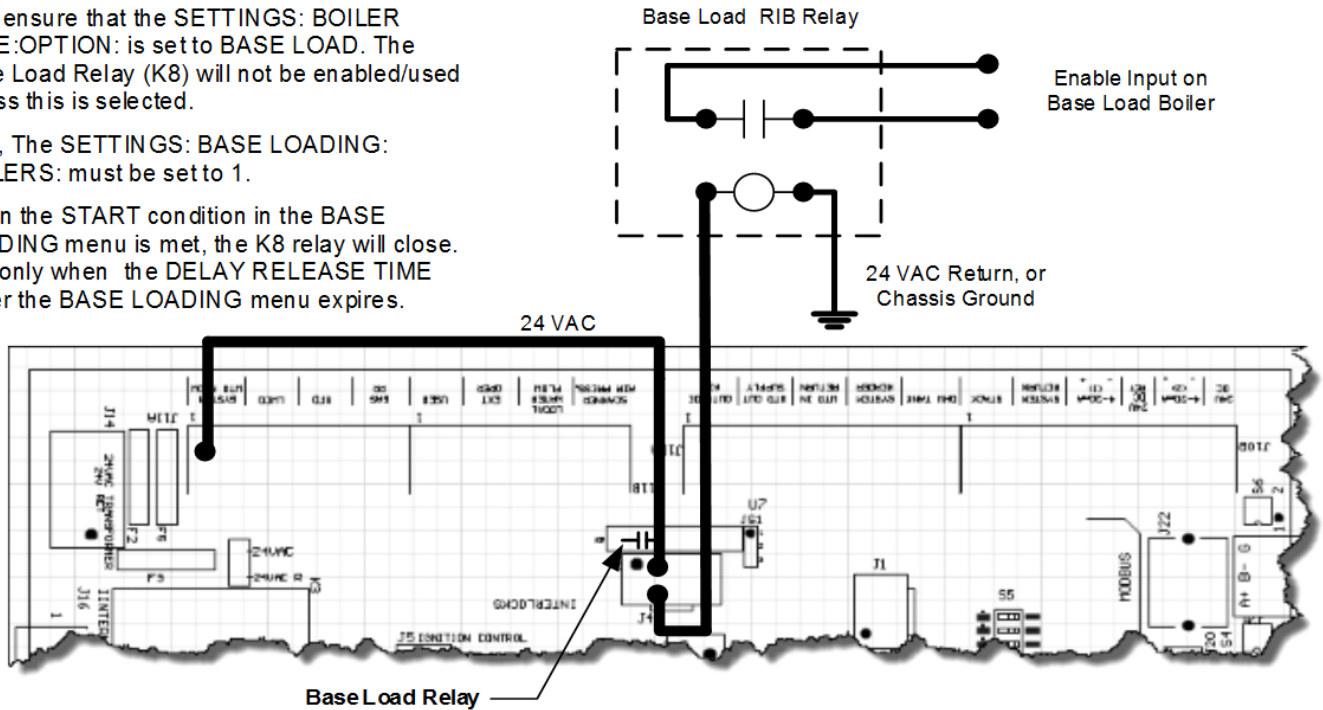
When all (4) HeatNet boilers are running @ 95%, the Base Load boiler is called on (demand is approx. 8 million BTUs). As the Base load boiler comes on it introduces 6 million BTUs and the HeatNet boilers modulate down to 25% for a total output of 2 million BTUs and running at high efficiency. The HeatNet boilers can now modulate to the load from 1.6 million BTUs (20% mod) to another 8 million BTUs.

**Not Preferred:**

Example of having a larger Base Load boiler that is not of the modulating type: If there is a 6 Million BTU Base Load boiler running with (3) 2 million BTU HeatNet boilers, a short cycling situation will arise when the (3) 2 million BTU boilers are running @ 95% and the Base Load boiler is called on. At this point there is a need for approximately 6 million BTUs. The (3) smaller boilers will then modulate down to low fire. At this point, the (3) smaller boilers need to shut off or the Base load boiler would need to shut off. There is no overlap. A selection for stopping the boiler now needs to be determined. Setting the Stop qualifier; Modulation to 40% or a low fire rate will shut the Base Load boiler off and allow the (3) smaller boilers to modulate up again (short cycle of the Base Load boiler; Use the Delay Timer and Min OFF timer). The Stop qualifier; Outside Air is above xxF may also be used if the system design temperature is known. Then let the Base Load boiler cycle off of its limits, whether a 2 stage, Hi/Lo, or modulating boiler. The default setting is for the Base Load boiler to stop first once the water temperature *exceeds the top of the heating band*.

**Figure 42** Example: Base loading relay

1. First ensure that the SETTINGS: BOILER TYPE:OPTION: is set to BASE LOAD. The Base Load Relay (K8) will not be enabled/used unless this is selected.
2. Now, The SETTINGS: BASE LOADING: BOILERS: must be set to 1.
3. When the START condition in the BASE LOADING menu is met, the K8 relay will close. But, only when the DELAY RELEASE TIME under the BASE LOADING menu expires.



## Setting up base loading

The base load boiler is controlled using a set of contacts to enable it (location J4). Enabling/Disabling this relay contact can be done using any combination of (3) qualifiers to start the boiler and (4) to stop the boiler. These qualifiers are:

### 1. Modulation %:

- a. **START menu item:** The relay contact will close when the MOD % from the Master boiler exceeds this value. **SETTINGS:BASE LOADING: START WHEN: MODULATION IS ABOVE**
- b. **STOP menu item:** The relay contact will open when the MOD % from the Master boiler falls below this value. **SETTINGS:BASE LOADING: STOP WHEN: MODULATION IS BELOW**

#### NOTICE

If the **START WHEN MODULATION IS ABOVE** value is set to a value higher than the **SETTINGS: MODULAR BOILER: MODULATION MAXIMUM**, all boilers will be firing before this modulation rate is reached. This will ensure that all available boilers are firing before the base load boiler relay is enabled.

- c. Setting the **STOP WHEN MODULATION IS BELOW** to a % value slightly above the min fire rate % of the system will ensure that the base load boiler will stop before the first condensing boiler stops. This is due to the Modulation rate being close to the min modulation rate before the water temperature exceeds the top of the heating band.

### 2. Outside Air Temperature:

- a. **START menu item:** The relay contact will close to enable the boiler when the OUTSIDE AIR read from the Outside Air Temperature sensor (if equipped) falls below this temperature. **SETTINGS: BASE LOADING: START WHEN OUTSIDE AIR IS BELOW.**
- b. **STOP menu item:** The relay contact will open to disable the boiler when the OUTSIDE AIR read from the Outside Air Temperature sensor (if equipped) rises above this value. **SETTINGS: BASE LOADING: STOP WHEN OUTSIDE AIR IS ABOVE.**

#### NOTICE

If the OUTSIDE AIR qualifier is used as the Start and Stop qualifier, ensure that there is at least a few degrees difference for hysteresis.

### 3. Return Water Temperature

- a. **START menu item:** The relay contact will close to enable the boiler when the RETURN IS ABOVE read from the Return Water Temperature sensor (if equipped) falls below this temperature. **SETTINGS: BASE LOADING: START WHEN RETURN IS ABOVE.**
- b. **STOP menu item:** The relay contact will open to disable the boiler when the RETURN IS BELOW temperature read from the Return Water Temperature sensor (if equipped) rises above this temperature. **SETTINGS: BASE LOADING: STOP WHEN RETURN IS BELOW.**

### 4. ALWAYS FIRST:

- a. **STOP menu item:** The relay contact will open to disable the boiler when the temperature exceeds the heating band. This gives the result of stopping the Base Load boiler First. Default setting.

## Delay time

The DELAY TIME is also included to hold off starting the boiler until the delay time is met. Once the start condition qualifier term is met, the DELAY TIME will start counting down. When the time expires, the base load relay contacts will close. **SETTINGS: BASE LOADING: DELAY TIME.** It is adjustable in a range of: 0 to 60 minutes.

## Base Load Failsafe

If:

- 1) There are no boilers available to fire (offline or faulted).
- 2) There are no boilers in local override.
- 3) There is a call for heat.

The J4 Base Load relay will close.

If a boiler becomes available and needs to fire, the Base Load boiler will remain firing until the temperature exceeds the band. This is provided to keep the system from entering a no heat situation.

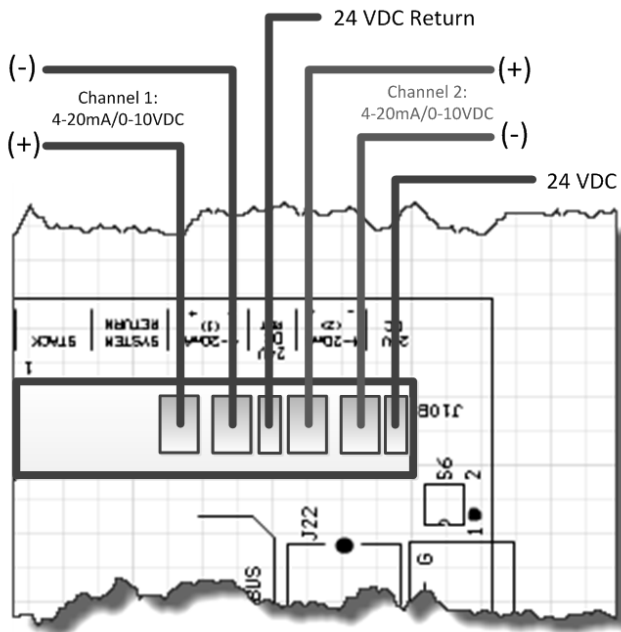
## Using the 4-20 mA input (OPTIONAL)

The 4-20 mA input is designed to operate per the ISA-50.1 standard. It will support Type 2, Type 3, and Type 4 Transmitter/Receiver circuits.

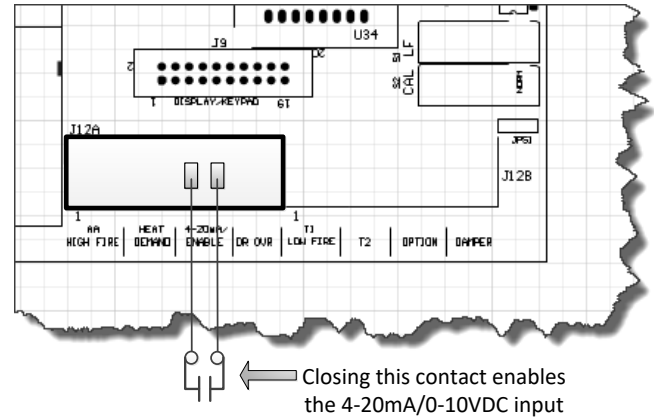
The Type 2 and Type 3 circuit may use the supplied +24VDC and 24VDC RET connections (J10B) to power a remote transmitter. The -ma terminal will need to have a jumper connected to the adjacent 24VDC RET terminal to reference the signal ground.

With the type 4 configuration, multiple boilers (up to 5), may be connected in series using the -ma +ma -ma +ma scheme (no jumper to 24VDC RET). This allows one 4-20 mA transmitter to control multiple boilers. A free-floating 250 ohm resistor is viewed by the BMS (or external control's) 4-20 mA transmitter across the + and -4-20 mA terminals with this method.

**Figure 43** Example: 4-20 mA connections



**Figure 44** 4-20 mA enable connection



The 4-20 mA input uses a 250 ohm sense resistor to convert the current to a voltage from 1 to 5 volts DC for the control to use. For this reason, a 1-5 VDC control voltage may also be used across the 4-20 mA +/- input, but it still needs to supply the necessary current, i.e. 20 mA. This resistor is located on the bottom side of the control board. When a 4.02 ma signal is sensed, the boiler will initiate a start sequence and fire the boiler at its minimum setting if the REMOTE ENABLE input is closed. This is typically 25% of the boilers output (4:1 turndown).

If the dip switch S6 is set to the 0-10 position (UP) See: Figure 51, the 4-20 mA input will accept a 0-10 VDC signal. The channel will also need to be setup in the menu: **SETTINGS: 4-20 mA INPUT: CHANNEL MODE**. The operating range will be from 2-10 VDC or twice what was previously stated for the 1-5 VDC functionality. **To convert a 0-10VDC signal to mA, divide by 2510 (ohms).**

**NOTE:** Due to the inability of control voltage methods (1-5, 2-10 VDC) to reject noise and compensate for line loss, the use of the 4-20 mA control current is recommended. The control voltage methods may be less expensive, but are the least stable. If using a 0-10VDC control signal, a source current of 5mA is required.

If using a remote panel with a relay and a 4-20 mA transmitter for operation, connect the 4-20 mA transmitter output from the remote panel to the member boilers using the floating 250 ohm method (type 4). The relay contacts on the remote panel will then be connected to the associated 4-20 mA REMOTE ENABLE inputs on the associated boiler(s).

**NOTICE**

For **Ametek** Blowers, the minimum signal to control the blower will be less than 20%, but the display % will be equal to the turndown % of the boiler. The signal sent to the Ametek blower is 0-20VDC, so the VDC reading will need to be divided by (2) to get the modulation % sent to the Blower. The Ametek blower also has a menu located at: **SETTINGS: BOILER: BLOWER**. This menu allows the Acceleration, Deceleration, and Soft Start Values to be set for proper operation of the Blower.

For direct fire applications (sending 0-10 VDC from a BMS), the 0-10 volt control signal is proportional to the output. Such that: 1 volt will track linearly by 10%. So, 1v=10%, 2v=20%, 3v=30%, 4v=40%... The control signal will still be limited by the turndown and the 4-20 mA INPUT menu. This means that the 1v signal will have no effect on a 5:1, 20% boiler. A ~2v signal will start the 5:1 boiler.

**Setpoint Control** functionality can be implemented remotely using the 4-20 mA input. This function translates a 4 to 20 mA control signal to a setpoint mapped from 50F to 220F. The feature is enabled in the SETPOINTS menu as: **SETTINGS: SETPOINTS: SETPT SOURCE 4-20 mA**.

**SETTINGS: 4-20 mA INPUT: CHANNEL MODE**. Also, when selecting; **SETUP: SETPOINTS: SETPT SOURCE** and selecting 4-20 mA, the 4-20 mA INPUT menu will be automatically entered.

You may select the current at which the boiler will start. It is adjustable from 3.7mA to 5mA. Hysteresis of .1mA is always in effect. So, if the starting mA = 4.10 mA the boiler will start when the control current applied achieves this value of 4.10mA. The boiler must drop .1mA below this to turn OFF, in this example 4.00mA. This hysteresis value is not adjustable.

When using the 4-20 mA setpoint control, a band may now be set at which the 4-20 mA signal will operate over. The lower setpoint is defined as 4mA SETPOINT and the upper setpoint is defined as 20 mA SETPOINT. The 4 mA SETPOINT is linked to the BOILER START x.xx mA where this starting current is the lower setpoint. So, if we set the 4 mA SETPOINT to 130F and the 20 mA SETPOINT at 180F we will have established the band. Once a starting control current of BOILER START 4.1mA is applied, and the 4-20 REMOTE ENABLE INPUT is closed, the boiler will start and the setpoint will be set to 130F. If a control current of 10 mA is applied the boiler will track on a linear slope towards the 20 mA SETPOINT settling at a SETPOINT of ~149F. As the current increases to 20 mA, the SETPOINT will indicate 180F. The Default setting is 4 mA SETPOINT: 50F, and 20 mA SETPOINT 220F for backwards compatibility with the older version.

**NOTICE**

Anytime a new firmware version is uploaded to the control, these values return to these defaults.

If using the direct modulation mode by applying a 4-20 mA current, only the BOILER START x.xx setting applies.

The 4-20 mA input can be set to HIGH PRIORITY. This is done in menu: **SETTINGS: 4-20 mA INPUT: CHANNEL MODE**. This allows a member boiler to be taken offline and directly modulated by an external control. If the Master is using it for heating and the 4-20 mA is set to HIGH PRIORITY, an external control can now output a 4-20 mA signal which will take over the boiler's fire rate. This is typically used for DHW control.

## Setpoint Priorities

Changing the setpoint can be done in many ways. If a higher level setpoint control is lost, the next level setpoint control is used until the System Setpoint is loaded. The setpoints are prioritized in the following order:

1. 0-10V, 4-20 mA Setpoint Control
2. BMS, Modbus Setpoint
3. Outdoor Reset Setpoint
4. Menu's System Setpoint

Any Setbacks that are active are then applied.

---

## Circulator Pump Options

There are provisions for a system pump(s) and a local pump. This is to allow for primary/secondary loop configurations. The system circulator pump is implemented using the K4, K13 RELAY and normally open contacts at J16 SYSTEM PUMP 1 and SYSTEM PUMP 2.

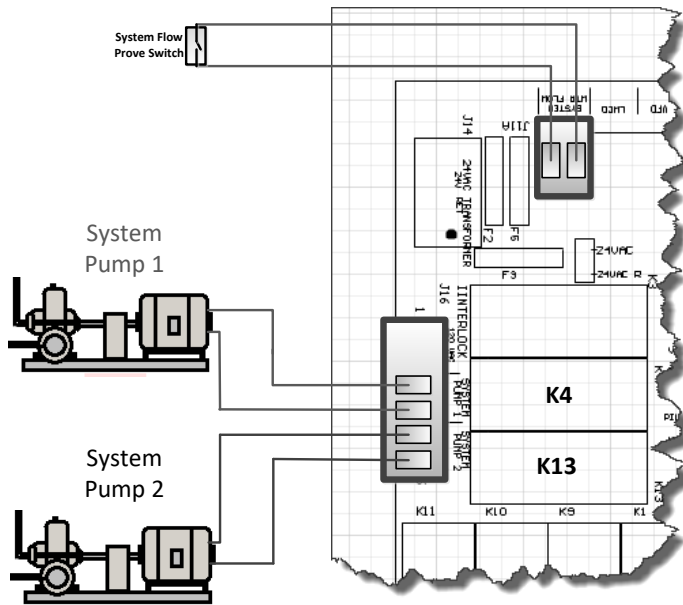
**NOTICE**

The pumps require motor contactors to isolate the on-board relay contacts. The on-board relays should never be used to energize large pumps directly. **Figure 45** illustrates the connections without contactors. The **system circulator pump** is supported by (2) modes and special features.

1. The first mode will allow the circulator pump to remain on, unless the control's outside high air temperature setting has been met when using OUTDOOR AIR RESET.
2. The second mode will allow the circulator pump to be turned on whenever there is a call for heat (any control input). This mode will stop the circulator pump when the call for heat is lost and the pump post purge time has been satisfied.



**Figure 45** System Pump connections



The summer pump jog is a special feature that can be selected when the system is in summer shutdown (OUTDOOR RESET). The jog allows the system circulator pump(s) and the local pump to run for the system pump purge time once a week. It can be set to any day of the week and will occur at 12:01 AM. If (2) system pumps are present, and after the first pump finishes its post purge, the second one will start and the first one will stop.

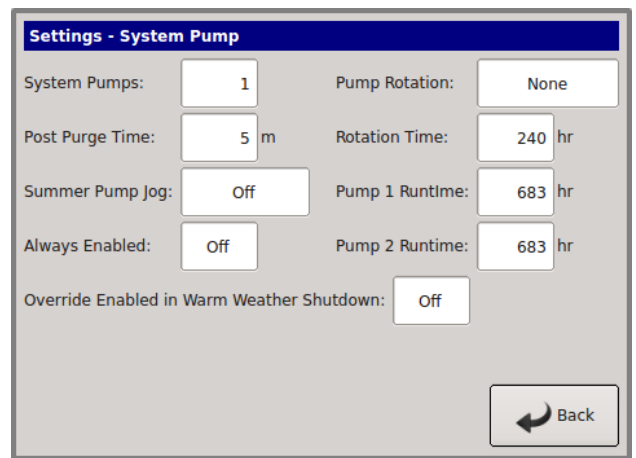
The system flow proving switch is implemented using SPARE 3/System Water Flow on J11A. If a flow switch is connected to the WTR FLW interlock, the HeatNet control will wait up to 10 seconds to prove flow. If flow is interrupted after it has been established, an error will be displayed and the boiler will cycle OFF. As long as there is a call for heat, every 10 minutes the circulator pump will try to re-establish flow and start the boiler again.

When (2) system pumps are present and flow is not established or is lost (2) things will occur to try and keep heat in the system.

1. **When first starting a system:** If after a 10 second wait to establish flow has failed, the first pump will change to the second pump. The second pump will now try to establish flow for 10 more seconds. If the second pump fails to establish flow, the HeatNet control waits 10 minutes. After the 10 minutes has expired, the control now starts with the second pump and attempts to prove flow for 10 more seconds. If flow does not prove, the control changes to the first pump and attempts to prove flow. This cycle will continue indefinitely until flow is established. **If flow is lost**

**while running:** this process is also used in an attempt to re-establish flow.

2. If PUMP ROTATION is set to PUMP HOURS the PUMP ROTATION will be temporarily set to SYSTEM HOURS. This is to prevent re-starting the failed pump due to its runtime hours. Setting the PUMP ROTATION to SYSTEM HOURS will allow a retry of the failed pump after the rotation hours has expired. Power cycling of the boiler or using the PUMP ROTATION menu will revert back to PUMP ROTATION = PMP HRS if this was the original setting.



For **system pump modulation** a 0-10Vdc control signal output is provided at J4.3 (signal) and J4.7 (ground). This signal is output by the Master boiler as a percent function of the number of boilers running and can be used to set the speed of a System Pump using a Variable Frequency Drive. Two wires are required and need to be inserted into the J4.3 and J4.7 positions to access this signal.

**Note:** This signal has a step response and is not linear to the system or boiler's input firing rate.

The output signal is proportionally mapped to % using the equation:

$$\% \text{ VFD} = (\text{boilers running} / \text{total boilers})$$

The % VFD represents the stepped percentage of boilers running where:

$$0\text{Vdc} = 0\% \text{ (to) } 10\text{Vdc} = 100\%$$

If there are (6) boilers in a system and (2) are running, the control signal = 33% or 3.3Vdc. This signal could then be applied to a system pump's VFD to control the speed of the pump relative to how many boilers are firing. The VFD would need to be set appropriately to allow the correct flow through each boiler.

In low volume systems sudden temperature changes may occur when the flow is stepped up or down by a large percentage. In these situations the **SETTINGS: ADAPTIVE MODULATION: MODULATION MODE** may need to be changed from **ADAPTIVE** and the **ORIGINAL KN** method used. Other adjustments may also be required.

Currently, no failsafe mode is available in the event the Master boiler's control fails. If this method is employed, a failsafe boiler could be used to override the control signal and enable the system pump's VFD using some external wiring and an external relay, or have the VFD default to a safe speed on loss of the control signal.

If (2) pumps are available, pump rotation is available. The rotation of the (2) pumps can be controlled using two methods.

3. Pumps are switched based on the system run time
4. Pumps are switched by the difference between each pump's runtime. The HeatNet control keeps a running record of each pump's runtime in hours. If a pump is taken offline or replaced. The runtimes can then be adjusted until they become equal.

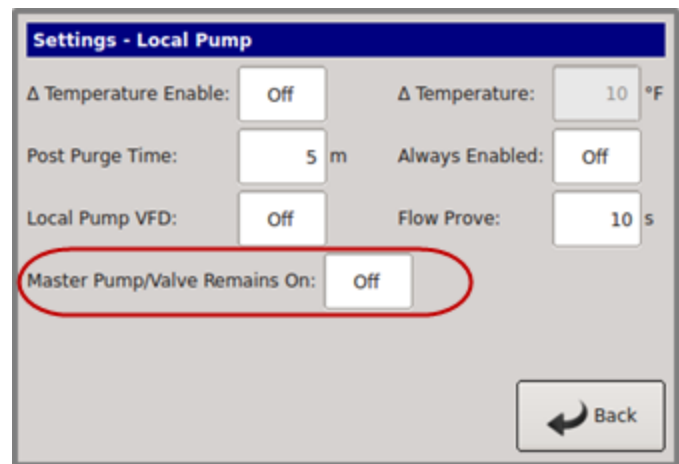
These features may be selected in the menu, **SETTINGS: SYSTEM PUMP: PUMP ROTATION**

The **local circulator pump** is supported by (3) modes and (2) features.

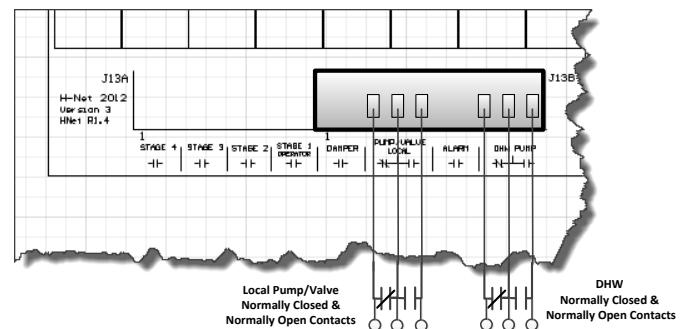
1. The first mode allows the circulator pump to remain on, unless the control's outside high air temperature setting has been met when using Warm Weather Shutdown.
2. The second mode will allow the circulator pump to be turned on whenever there is a call for heat (any control input). This mode will stop the circulator pump when the call for heat is lost and the pump post purge time has been satisfied.
3. The third mode works much the same as mode 2, but it allows the inlet sensor (RETURN) to be used with the outlet sensor (SUPPLY) to keep the pump on until a delta (difference) temperature is met. A return temperature sensor is required for this mode, because the delta temperature (SUPPLY – RETURN) measured is across the boiler. In this mode, the post purge time is also used. After the delta temp has been met, the post purge time needs to expire before the pump is turned off. This mode works much the same as mode 2.

## Local Pump Options

**MASTER PUMP/VALVE REMAINS ON:** This is a special feature of the local circulator pump to prevent deadheading water flow when all boilers are off. When this feature is enabled, the Master boiler will enable its local circulator pump/valve when **NO** boilers are running. If boilers are running in **LOCAL** override and not controlled by H-NET, but are visible to H-NET, the pump(s) on these boilers are presumed ON. In this situation, the Master **will not** enable its circulator pump/valve unless it is running.



**Figure 46** Local & DHW Pump connections



Another feature of the **PUMP/VALVE OPTION** is to control a local (primary) pump using a Variable Frequency Drive. This feature may be required when a secondary system pump is also variable speed. To enable this feature **SETTINGS: LOCAL PUMP: LOCAL PUMP VFD: ON**. Setting this Option to ON will map the control signal on J4 pins 1+ and 5- to the modulation rate. (2) Wires need to be run from J4.1+ and J4.5- to the VFD's input connection. Ensure that the JS1 shunt jumper on the control board is in position 0-10 or 4-20 mA as required.

## Combustion Air Damper

Relay K5 and the terminal J13 DAMPER is used to control a combustion air damper. J12B.7 & .8 are used to detect the dry contact proof switch from the damper. A proof time of up to 4 minutes can be set before the boiler can start or an alarm condition will occur. The Combustion Damper can be setup in the **SETTINGS: COMBUSTION AIR DAMPER** menu.

Using the LINKED/COMMON setting, the Master boiler controls a system damper, so in the event this damper fails to open, the system will not start. If the Master boiler's system damper fails, then no call for heat will be made to the member boiler(s).

Using the INDEPENDENT setting, each member boiler can control its own damper and is independent of the Master boiler when a call for heat is made to the member. This allows for separate dampers for each boiler. They can be wired to J12B terminals 7 and 8.

If a common system damper is used (controlled by the Master boiler), each individual boiler must prove that the combustion air damper is open when it is placed in LOCAL. This may be done using J12B terminal 7 on all boilers wired to the damper's prove switch. Terminal 7 is the sense input and terminal 8 is 24 VAC. Connecting a wire to terminal 8 is not recommended.

See Figure 58, *Common system damper wiring*, Page 84.

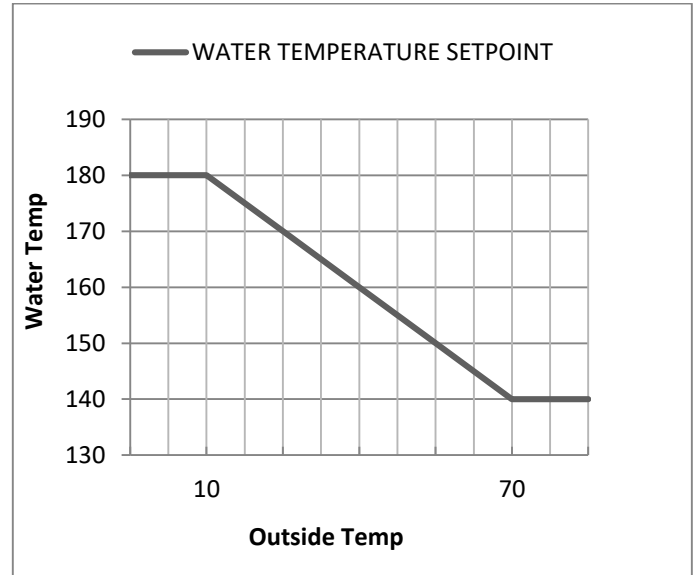
**NOTICE** A separate/independent 24 VAC source is recommended to be used for the damper prove switch when a common system damper is used. If you use terminal 8 to supply power from the Master and the Master is powered OFF, no boiler will be allowed to fire due to the loss of power through the prove switch. A backup boiler will also need to have the damper relay contacts wired in parallel with the Master for when the Master is powered OFF.

A second wire on the Master J12B terminal 7 is then connected. The other end of this wire is then run to the first Member boiler J12B terminal 7. If another member boiler is present, a second wire can be connected to the first member boiler J12B terminal 7 and the other end connected to the other boiler J12 terminal 7. This method can be continued if additional boilers are present. This input must be selected in the **SETTINGS: COMBUSTION AIR DAMPER** menu.

## Outdoor Reset

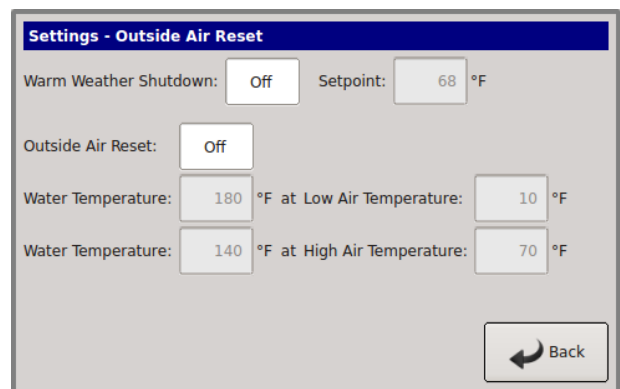
The Outdoor reset feature allows the water setpoint temperature to change dynamically with the outside air temperature. It also provides an adjustable temperature that shuts the boiler (or boiler system) down when the outside temperature rises above it.

**Figure 47** Outdoor reset curve, typical



The above chart shows how the water temperature setpoint changes with the Outside air temperature. The four values of 180, 10 and 140, 70 are the default values:

WATER TEMP LOW OA TEMP	180 °F 10 °F	Water temp @ outside air temp
WATER TEMP HIGH OA TEMP	140 °F 70 °F	Water temp @ outside air temp
WWS Setpoint	72 °F	Outside air temperature where Warm Weather Shutdown occurs
WARM WEATHER SD=ON		If set to ON here



The chart depicts what the water temperature setpoint will equal with a corresponding outside air temperature. At an outside temperature of 10F and below, the water temperature setpoint will be limited to 180F. With an outdoor temperature of 70F and above, the water temperature will be limited to 140F. The water temperature setpoint will track along the charts plotted line with corresponding outside temperatures.

The OR OVR (Outdoor Reset Override) input on J12A can be used to override this Outside Air Setpoint and maintain the water setpoint at the LOCAL or SYSTEM SETPOINT value when a contact is closed across this input. This can be used as a Domestic Hot Water demand input.

Another function of the OUTDOOR RESET is the Winter/Summer mode ((W)arm (W)eather (S)hutdown). With the WWS SETPOINT set to 72F and WARM WEATHER SHUTDOWN set to ON, the boiler/system will enter summer shutdown when the Outside Air temperature rises above 72F. While in this state, the OR OVR input on J12A can be used to bring the boiler/system on to maintain the water setpoint at the LOCAL or SYSTEM SETPOINT value.

During WWS operation, the System pump will not be enabled just the Local pump unless the SETTINGS: SYSTEM PUMP: OVERRIDE ENABLED IN WARM WEATHER SHUTDOWN is set to ON. This is the System Pump Priority mode. When SETTINGS:SYSTEM PUMP: OVERRIDE ENABLED IN WARM WEATHER SHUTDOWN is set to OFF, the system pump will not come on while in WWS with the OR OVR override input closed.

## Sensors

The H-Net control supports a standard 10K thermistor (Type ACI/10K-CP). These sensors can be calibrated to the control by entering the sensor menu and placing a precision 10k resistor on an input.

**NOTICE** Immersion sensors must have wells.

There is also a provision to use a 1K platinum sensor for the stack temperature. The 10k thermistor is limited to a usable range of 270F, and the 1k platinum sensor to upwards of 1000F. The S5 DIP switch is used to configure one or the other.

## Stack Temperature

The version 3 control also supports an optional 1k platinum stack sensor. If the Stack Sensor is present, a warning will occur at 325F and greater. During the Warning condition, for every degree F over the warning temperature of 325F, the boiler's input will be limited by 4% until the boiler is running at low fire. If the SETTINGS: HEAT EXCHANGER: ALARM TYPE: is set to "FAULT" the boiler will halt and the Alarm relay will close when the Stack temperature exceeds 350F. The boiler will then be allowed to restart when the Stack temperature drops below 325F.

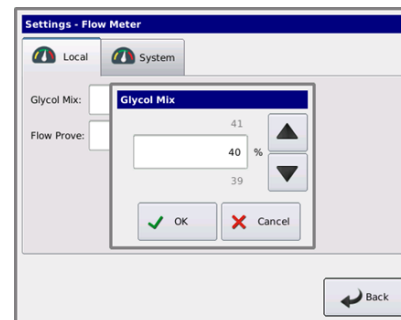
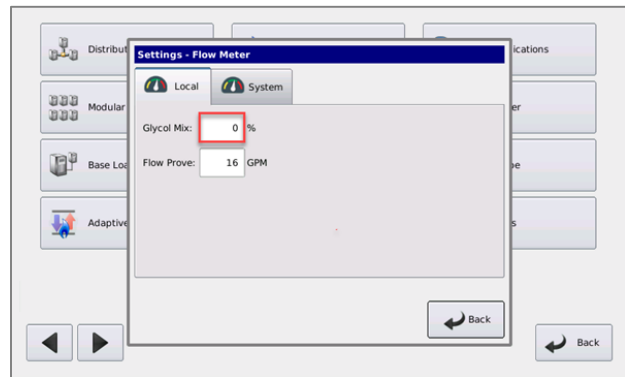
The Stack sensor should be a 1k ohm platinum type sensor. Part # 0040-1300. To configure the 1k PT Stack sensor, Switch S5.3 should be set to the NONE position and S5.4 set to PLATINUM STACK. The sensor will then be auto-detected after a power cycle.

## Local Flow Sensor

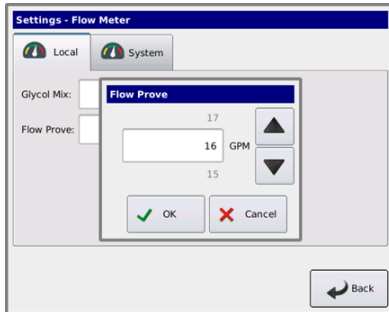
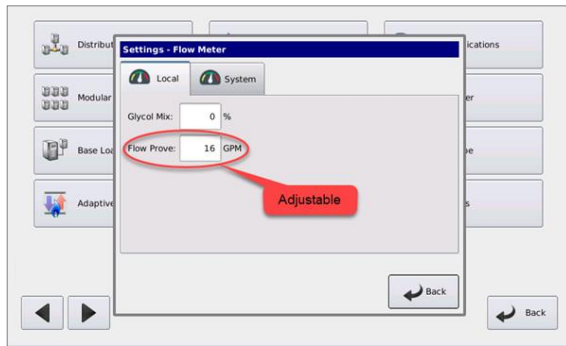
The Flexcore boilers come equipped with a flow sensor that sends flow information to the HeatNet control and display's the water flow information in GPM's at the "Local Flow" icon on the touchscreen display.

The Local Flow Sensor settings are located in the Flow Meter menu. Prior to making any adjustments to the "Glycol Mix: %" or the "Flow Prove: GPM", make sure the correct boiler size is chosen in the "Boiler Type" menu, and the defaults are loaded.

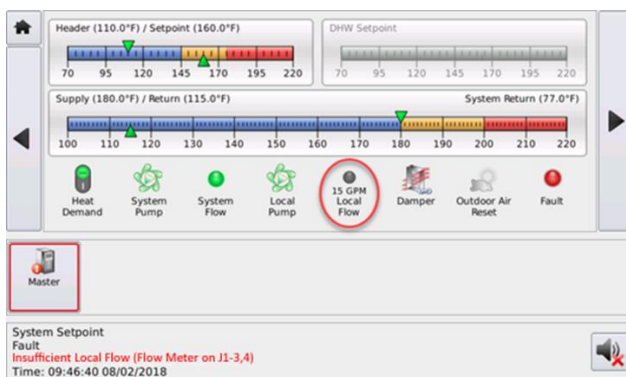
When Glycol is added to a system the flow characteristics of the water are affected, so it is important to enter the correct Glycol Mix % value. If the system is using Glycol enter the % of the glycol mix, then select "OK".



To maintain a minimum flow through the boiler, the "Flow Prove: GPM" is adjustable. Enter the minimum flow that the boiler is to prove and operate above, then select "OK".



When the boiler has a heat demand it will not start until the programmed GPM requirement is met. If the boiler is running, it will also stop firing when the GPM falls below the Flow Prove value. In this case the minimum flow is below the required 16 GPM so the boiler will not start. The flow proof time has expired and then enters into a fault condition.



The touchscreen displays a visual flow fault and the control will announce an audible fault. After ten minutes, if the demand is still present, the boiler will retry to start the pumps to achieve flow and start the boiler. If there are other boilers on the network the Master will attempt to start one of them.

## Security

A password can be used to lock out control and setup features. It can be enabled, but is shipped in the disabled state.

## Save/Restore Configuration Settings

In a complex system, there can be a multitude of settings necessary for proper boiler operation. These settings can be saved to the onboard memory, and/or a USB drive. **SAVE SETTINGS: ONBOARD MEMORY/USB FILE**

Saving to the on-board memory is useful when changes have been made to the settings menu, prior to upgrading firmware, or doing a factory reset. Upon completion the settings can then be loaded using, **RESTORE SETTINGS: ONBOARD MEMORY**.

Saving to a USB drive is useful if a control board has to be replaced. The file on the USB can be loaded on the new board using the **RESTORE SETTINGS: USB FILE**.

## USB Features

The HeatNet V3 control supports a USB updating system and desktop connectivity using the HeatNet Control Pro software.

In order to ensure that a valid firmware file is always available on the HeatNet board, (2) file storage locations are available. A firmware file is loaded at the factory in both locations. This is to ensure that if a bad file is loaded by the user, the factory loaded file can be re-loaded to get the board functional again. All updating of firmware for Touchscreen Display applications use the front panel USB input.

The firmware loading menu is located at; **SETTINGS: LOAD DISPLAY FIRMWARE & SETTINGS: LOAD CONTROL FIRMWARE**. The following explains the menus.

### Loading the Display Firmware

Selecting the **LOAD DISPLAY FIRMWARE** menu allows updating the displays application program which resides on the display. This does not update the controls firmware. New firmware is posted periodically on Sales Assistant or the RBI website.

### Loading the Control Firmware

Selecting **USB DRIVE** will read the **FIRMWARE** directory on a flash drive and display any .hex files located there. The USB flash drive needs to have a directory called "firmware" located in the root directory. The downloaded firmware .hex file needs to be placed there. Then the flash drive needs to be inserted into J6 on the HeatNet control board. Follow the on screen prompts and then select the file using the arrow keys.



Once a file has been selected, a **STORAGE LOCATION** needs to be selected. There are (2) storage locations for the new file. Location 1 is used for normal updates and Location 0 is for the factory stored backup file. When the Storage location (default is Location 1) is selected the file will be loaded into a permanent storage memory location. Next, the control will reboot and copy this new program into running memory, reboot, load factory defaults, and then reboot again.

Selecting **USB CABLE** requires connecting a USB cable and running the Firmware Update program from a PC directly to the USB port on the control board (not the front Panel). This process takes much longer and requires a Personal Computer (laptop) to be taken to the boiler site. Again, follow the on screen prompts to download the program into a storage location as done when using the above **USB DRIVE** loading menu. You will need the HeatNet Pro software which can be downloaded from the website.

Selecting **SAVE FILE** will display the currently stored files in the storage memory locations. Use the arrow keys to select a stored file for copying to running memory. When **SELECT** is pressed the file will be marked so it will be loaded on the next power cycle. Power cycle the boiler to begin copying the file from stored memory to running memory.

**NOTE:** to access the factory backup program, the P3 BOOT shunt on the HeatNet control board needs to be connected and the CAL/NORMAL switch placed in the CAL position. The BOOT jumper is located close to where the ribbon cable for the display plugs in. If the control is power cycled in this condition, the factory program will overwrite the existing running program. If in the **LOAD FIRMWARE** menus, **STORAGE LOCATION 0** will be an allowed storage location.

---

## Diagnostics

The H-Net control can display and identify faults in a meaningful way. If an interlock trips, it will be indicated in the main screen display, along with an audible alarm (mounted on control board) and a set of relay contacts will close. A record of this, with a time stamp, will also be entered into the log as an aide in the diagnosis of the event. The log can be downloaded and a histogram used to display the data. If using Modbus, BACnet, or LonWorks, there are software flag bits in registers available.

Open and shorted sensors are checked continuously, so that in the event of a sensor failure, the system shuts down and the alarm relay is closed. If the sensor returns to operation the alarms are automatically cleared and operation is restored.

If a pump fails (flow switch required), or the flow switch fails, the boiler will cycle the start condition every 10 minutes in an attempt get the boiler restarted.

If the damper fails to open and never closes its proof switch, a retry algorithm will attempt a retry. Every 10 minutes the

damper relay will cycle and try to open the damper again.

If the H-Net control closes the last interlock string connected to the ignition control and the ignition control never closes its Blower Relay, the H-Net control will wait 2 minutes. The H-Net control will then retry for the duration of the local pump post purge time and then retry the ignition sequence. During this time “retry strt” will be displayed in the status screen. After (5) attempts the H-Net control will lock out and display call service.

---

## Blower Protection

With the use of the Ametek blower the HeatNet control has assumed many of the responsibilities that the Variable Frequency Drive provided. Some of these include Acceleration, Deceleration, Braking, and Soft Start.

The most sensitive of these (4) functions is the Soft Start. The Soft Start overcomes the motor’s attempt to run at a high rate of speed before overcoming inertia. In the larger Ametek blowers, a higher starting torque is required to break the inertia of the Ametek’s flywheel effect. If the Ametek motor cannot transform its electrical energy into mechanical energy fast enough, (due to this inertia) a high input current to the motor will result. The Ametek motor would then shut down and lock out due to this current. The only way to reset the Ametek blower due to the over current condition, is to power cycle the boiler.

Also, due to the nature of the inverter circuit that is used to change the AC line input to a DC voltage to power the motor, a sizable bank of capacitors is used. When the blower is first powered up, these capacitors are empty and develop a large inrush of current.

In order to provide a means of controlling these situations and preventing downtime, the HeatNet control allows a relay to control the power fed to the blower. This is done by wiring the 120 VAC power to the J13A.1 Stage 4 relay contact using black 600 V, 18 gauge, MTR/TEW wire. Then wiring (same wire type) from J13A.2 to the Ametek blower contactor’s enable input. This allows the HeatNet control firmware to control power to the blower by switching the contactor ON or OFF. The reasons for this are as follows:

1. The Stage 4 relay has been allocated to help bring the power up in steps. These steps are used to minimize inrush currents by engaging the blower’s contactor (7) seconds after the main power has been applied.
2. In the event a blower lockout has been determined, a (10) minute retry cycle, (3) times will occur. At the time the blower has been detected as locked out, the retry cycle will start. The Stage 4 relay will be de-energized for (8) minutes. Then the Stage 4 relay will be energized for (2) minutes. This will effectively power cycle just the blower. The call for heat will then be allowed in an attempt to start the boiler. After (3) failed retry attempts, the boiler will lock out.

## Communications

The H-Net control has the ability to communicate using the MODBUS protocol with a building management system. Most registers and functions are available for MODBUS access. Access is allowed using the RS485 MODBUS PORT connector on the communication board. Version 2.x Control has these connections integrated on the main board.

An optional BACnet or LonWorks bridge module can be used to connect the MODBUS network to a BACnet or LonWorks network. See Method 5 control.

The system setpoint timer and system setpoint work in tandem to externally control (i.e. a BMS - building management system) the operating setpoint. The setpoint (countdown) timer should be loaded with a timeout value (in seconds) prior to writing the system setpoint. When the timer reaches zero, the control assumes that the BMS is no longer operating and the local setpoint (saved on the control) is reloaded. If the setpoint timer is not written, a default timeout value of 60 seconds is assumed. The timer is automatically reloaded with the default value when a setpoint is written.

**NOTICE** The BMS mode is always on by default. To disable or change the time watching the BMS communications, go to the Setpoint Timer item in the Communications menu.

## Failsafe Modes

FAILSAFE MODES have been added to help protect systems from loss of heat conditions. When using one of these modes **ensure that you connect any DAMPER control, or system pump control to safely allow operation** with the assumption that the MASTER boiler or BMS system is DOWN.

### Failsafe Requirements

1. Since the Member boiler that will be assigned the Failsafe duty will always turn the system pump ON, this boiler should not be used for DHW heating. If the Master controls the system pump, then the Failsafe Member boiler would need to control the system pump in parallel with the Master boiler. Wire the System Pump contacts in parallel with the Master.
2. If the combustion air damper is used as a common system damper, the Failsafe boiler should be wired to control the damper in parallel with the Master boiler.
3. The Failsafe boiler must have the LOCAL SETPOINT set to the same setpoint temperature as the Master boiler's SYSTEM SETPOINT.

Be aware that the boiler may start without a call-for-heat in the FAILSAFE MODES. FAILSAFE MODES can be accessed through the:

The following are types of Failsafe conditions.

1. Building Management System Failure

If a BMS system is controlling the setpoint and enabling the boiler system, a timer is provided to allow operation of the system in the event that communications are lost with the BMS system. The HeatNet boiler system will run locally if communications is lost and this timer expires due to the lack of being updated.

### SETUP: AUX FUNCTIONS: FAILSAFE MODES.

2. HeatNet Communications Lost

#### SETUP: AUX FUNCTIONS: FAILSAFE MODES: H-NET COMM LOST

This mode allows a member boiler to run in LOCAL if the communications link via the H-NET cable is lost. This includes the MASTER boiler losing its Control board, Communications board, or the power on the MASTER is switched OFF. When this MODE is set to ON, and if the member boiler loses its link (heartbeat packet over the H-NET cable) to the MASTER Boiler, this MEMBER will fire to the LOCAL setpoint.

**NOTICE** The heartbeat packet over the H-NET cable needs to be lost for 10 minutes.

This MEMBER boiler will continue to run at the LOCAL setpoint until H-NET communications from the MASTER boiler is re-established.

Ensure that this Member boiler's Damper and System pump control are configured correctly with the assumption that the Master is not powered. Also ensure that any other System settings related to outside air temperature sensing and system interlocks are set to provide safe operation. Domestic Hot Water can also be provided using this mode. See the DHW section of this manual.

3. Low Temperature Protection

#### LOW TEMP: OFF, SUPPLY, HEADER, DHW, or RETURN

This mode may be used by the MASTER or MEMBER boiler and can be used as a type of freeze protection. In this mode you may select which Sensor you wish to monitor, or you may opt to turn this mode OFF. If you select a sensor, you may then associate it with a

temperature at which the boiler will turn ON. Once the temperature at this sensor falls below the LOW TEMP temperature the boiler will start and fire to its LOCAL setpoint. Once the Boiler reaches its setpoint it will turn OFF.

4. Using the Base Load Relay

If there are no boilers available to fire (offline or faulted) and there are no boilers in local override, and there is a call for heat, The J4 Base Load relay will close. If a boiler becomes available and needs to fire, the Base Load boiler will remain firing until the temperature exceeds the band. This is provided to keep the system from entering a no heat situation.

## Limited Flow Boiler Control Options

Three methods to limit the boilers operation based on flow are provided.

1. Flow Limited Control (BMS)
2. Boilers Limited Control (BMS)
3. System Flow Meter

The flow settings are used to limit HeatNet’s ability to add boilers when the system flow changes. In variable flow systems, and when the system flow is reduced, any boiler(s) that is/are running may develop a high delta temperature across the boiler. When this occurs, the boiler(s) will enter a high delta T protection mode and drop to half of the rate called for. At this time, the Master may not be able to achieve setpoint due to the reduced output with the running boiler(s). The Master will then call on more boilers to achieve setpoint, but at the same time splitting the flow through the boiler(s) it has running. The flow can be so reduced that the boiler(s) trip their operating limits or even their high limits.

A flow meter input is supplied on the analog input 4-20 mA (2). This input can be configured to capture flow in the system that will be used to limit the # of boilers to fire. If a flow meter and a System Return sensor are present, a BTU load measurement will be displayed in the running screen. The BTU value is relative to the accuracy of the sensors, the gas BTUs, the flow sensor accuracy, and is only available as an estimate of the BTU load. A calibrated BTU meter would be required to get a more accurate measurement.

The BTU load value may also be accessed through Modbus read registers 30242 (upper 16 bit word) & 30243 (lower 16 bit word). These two words will need to be combined in order to get the BTU load value.

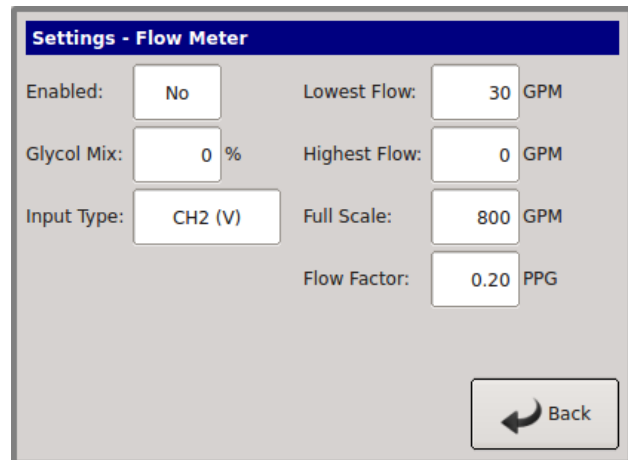
When using the BMS GPM register the BTU values are only calculated to a whole GPM since the BMS GPM register currently does not support floating point numbers.

The Building Management System (BMS) also has the ability to limit the # of HeatNet boilers allowed to fire. When a system has a fixed amount of boilers that HeatNet reports are available, the BMS can limit the # of boilers that can fire. The BMS can write the GPM value it has for flow, or directly write a register with how many boilers HeatNet can control. If the BMS GPM flow feature is active, the direct control becomes inactive.

**Note: Using these features can limit HeatNet’s ability to maintain setpoint.**

1. **Flow Limited Control:** This method helps HeatNet to limit the # of boilers firing based on the System Flow in GPM. In variable flow systems, this will limit HeatNet’s ability to add new boilers when insufficient flow is available. The # of boilers allowed to fire is determined by:

$$\# \text{ Of HeatNet boilers that can fire} = \frac{\text{BMS GPM Set Rate}}{\text{LOWEST FLOW}}$$



To activate this flow limited feature for use with a BMS:

- b. Set SETTINGS: FLOW METER: ENSBLED? YES
- c. Set ADVANCED SETTINGS: FLOW METER: GLYCOL MIX ? %. Currently, any mix over 10% de-rates the flow by 30% (rule of thumb method). Example: if the LOWEST FLOW = 50 GPM, HeatNet will calculate a New Lowest Flow required to be 65 GPM. The LOWEST FLOW does not need to be changed, but is calculated to 65 GPM and that value is used by HeatNet.
- d. Set SETTINGS: FLOW METER: INPUT TYPE to BMS.
- e. Set SETTINGS: FLOW METER: LOWEST FLOW (The automatic value loaded will equal the lowest



flow required for this boiler (it is adjustable). It should be = to the lowest flow of the largest boiler in the system). The HIGHEST FLOW & FLOW FACTOR are currently not used with this release. Once flow meter manufacturers have been determined, new firmware will become available.

- f. Write to address BMS GPM register 40019 with a valid flow (0 -1500 GPM).
- g. **If a new GPM value is not written within 10 minutes, this feature will be deactivated until a new flow value is written. Ensure periodic updates of the flow register are done within 10 minute intervals.**
- h. To check if HeatNet is in a flow limited state, read the boiler status 4 register starting at address 30160 for the Master Boiler; if Status 4 bit (12) is set, it indicates that the HeatNet control is running with limited boilers due to insufficient flow derived from the GPM value.

- **Boilers Limited Control:** This feature allows the BMS to directly change the amount of boilers that HeatNet can control.

To Activate the Boiler limited feature:

- Read Modbus address 30241 to see how many boilers HeatNet has available to fire. MODBUS AVAILABLE BOILERS register.
- Determine how many boilers the BMS system will require.
- Write to address BMS LIMIT BOILERS register 40020 with the # of boilers HeatNet is allowed to control (0 - 16).
- **If a new boiler # value is not written within 10 minutes, this feature will be deactivated until a new boiler # is written. Ensure periodic updates of the flow register are done within 10 minute intervals.**
- To check if HeatNet is in a BMS limited state, read the boiler status 4 register starting at address 30160 for the Master Boiler; if Status 4 bit (13) is set, it indicates that the HeatNet control is running with limited boilers due to the BMS system specifying BMS LIMIT BOILERS being less than the available boilers.

3. **System Flow Meter:** Used to control the # of HeatNet boilers allowed to fire. HeatNet will look at the # of boilers it has available, and the amount of system flow to determine how many of boilers it can fire.

**As an Example:** An Onicon F-1210 Flow Meter provides simultaneous 0-10V and 4-20 mA outputs, so if the BMS system is using (1) output, the other may be used by HeatNet.

To activate this flow limited feature for use with an Onicon Flow Meter F-1210:

- a. Set SETTINGS: FLOW METER: ENABLED: YES
- b. Set SETTINGS: FLOW METER: GLYCOL MIX %. Currently, any mix over 10% de-rates the flow by 30% (rule of thumb method). Example: if the LOWEST FLOW = 50 GPM, HeatNet will calculate a New Lowest Flow required to be 65 GPM. The LOWEST FLOW does not need to be changed, but is calculated to 65 GPM and that value is used by HeatNet.
- c. Set SETTINGS: FLOW METER: INPUT TYPE to mA 2 or VOLTS 2 depending on whether a 4-20 milliamp or 0-10 volt signal is used. The connection should be made from the Flow Meter to analog input 4-20 mA (2).
- d. Select SETTINGS FLOW METER: LOWEST FLOW: (The automatic value loaded will equal the lowest flow required for this boiler (it is adjustable). It should be equal to the lowest flow of the largest boiler in the system).
- e. Set the SETTINGS: FLOW METER: FULL SCALE value to the full scale reading on the calibration card that came with the flow meter.
- f. The HIGHEST FLOW & FLOW FACTOR currently are not used with this release.
- g. These settings will use the equations:

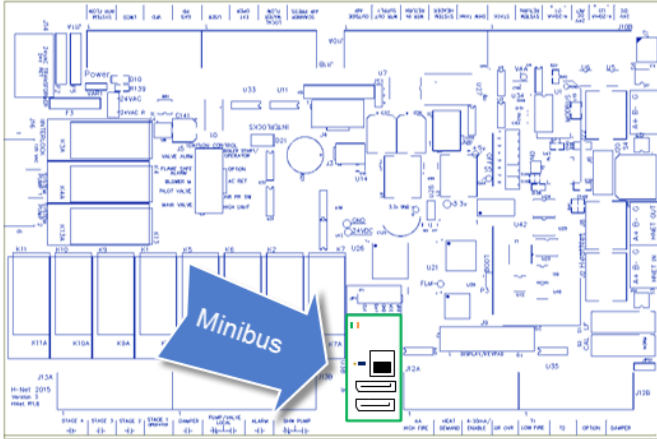
$$4-20 \text{ mA: } \text{Measured GPM} = (\text{signal}/16) * \text{FULL SCALE flow}$$

$$0-10 \text{ Volt: } \text{Measured GPM} = (\text{signal}/10) * \text{FULL SCALE flow}$$

These settings may work with other flow meters (consult their respective manuals).

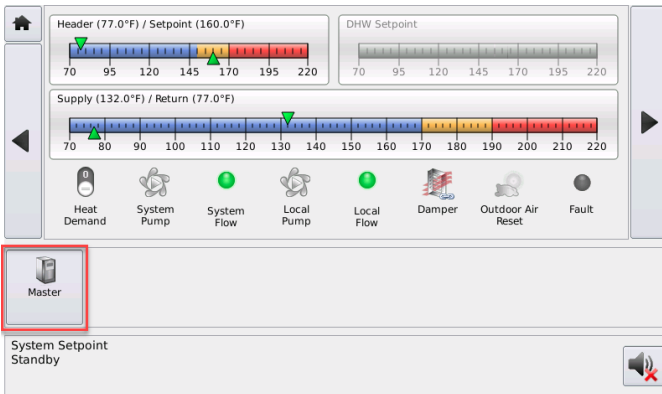
# FlexCore Multi Heat Exchangers

Some FlexCore Series boilers contain multiple heat exchangers. With this release, models after CK-3000 contain more than one heat exchanger. These units rely on multiple HeatNet controls that communicate between each other. In order to do this, the Minibus was created. The Minibus uses high speed serial SATA cables, a special interface, and is located where the HeatNet Online module was.



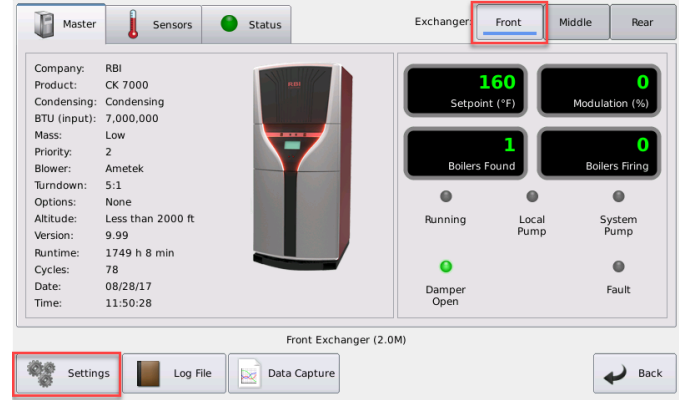
HeatNet controls attached to each heat exchanger are designated either as a Manager, or a Subordinate. When setting up a multi-heat exchanger FlexCore, the front exchanger's control is always designated as the Manager of the boiler and the minibus. The other controls in the boiler are set as subordinates and given a unique address. These roles and addresses can be changed in the Settings – Distributed Control menu.

To access the heat exchanger menus, select the boiler icon button outlined below on the main screen. That will take you to the Boiler Information screen.

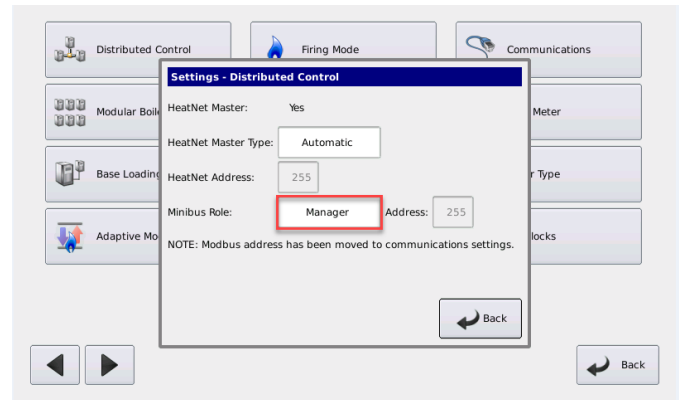


From the Boiler Information screen, select the heat exchanger button to be set up. It is in the top right corner of the screen. Then select the settings button.

## Manager Control



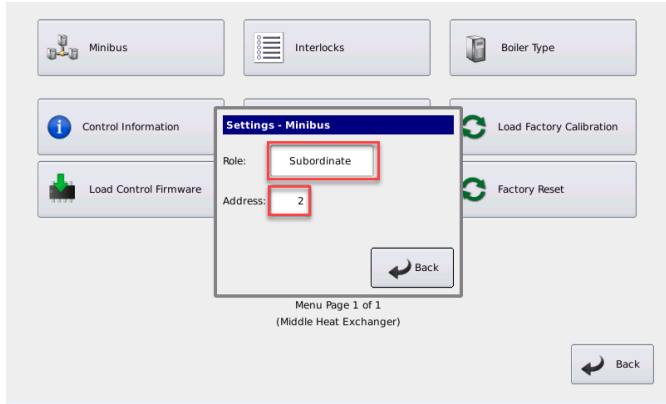
## Manager Minibus Settings



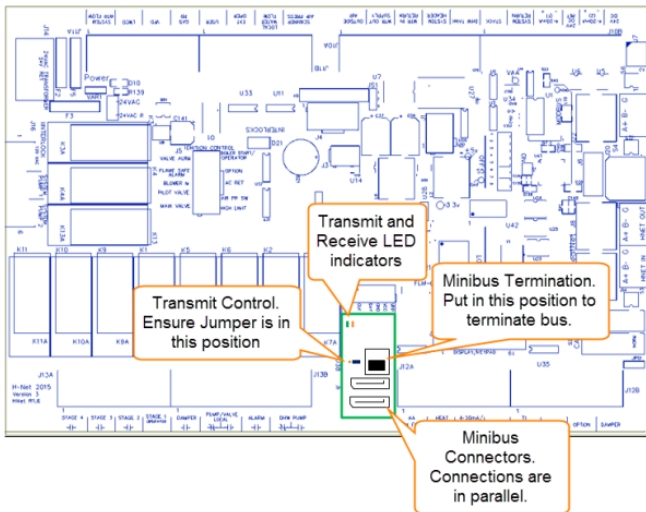
## Subordinate Control



Subordinate Minibus Settings



The first and last Heat Exchanger must have the minibus terminated for the bus to work properly. S1 would be placed in the ON position as indicated below for the front and rear heat exchangers. The jumper, JS1 must always be in the position indicated (closest to S1). It is used for testing

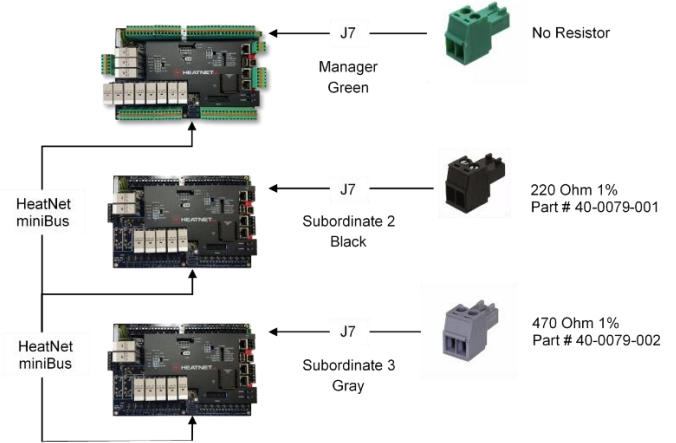


When these roles are set, the minibus connector board will blink its LEDs. There is a green LED for transmit data and an Amber for receive data. The Manager starts/stops all Subordinate boilers and monitors their activity, so its transmit LED will be very active.

FlexCore Configuration Plugs

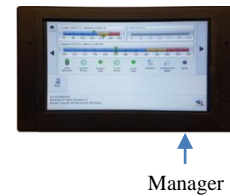
FlexCore models larger than CK-3000 use configuration plugs to make setup easier. The configuration plugs are color coded for identification. Each FlexCore boiler will ship with the correct configuration plugs installed in J7 on all controls. When a HeatNet V3 control board is replaced, the J7

configuration resistor from the original control should be transferred to the replacement control. The configuration plug will enable minibus communications and set the correct minibus address.



Color Display Wiring

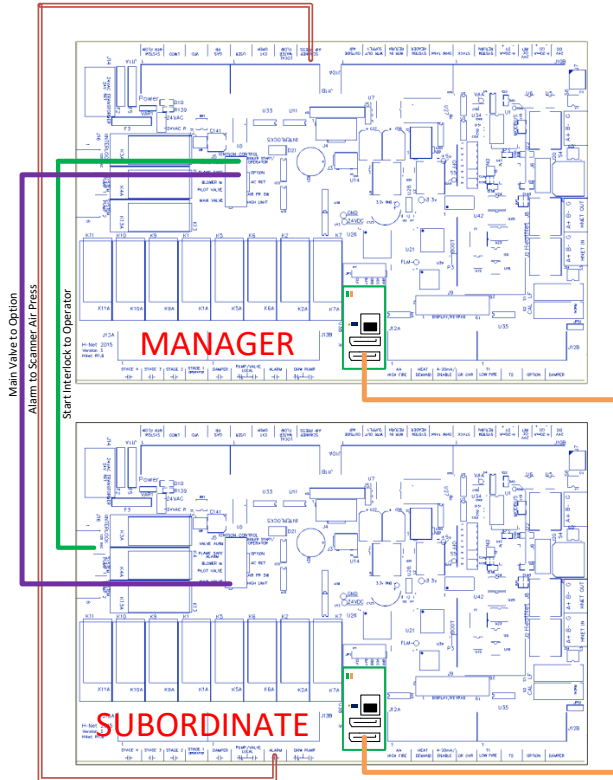
Only the manager control needs to be connected to the color display using a ribbon cable. All subordinate control and display information is communicated to the manager control via the minibus.



In addition to the control and status information that is transferred between HeatNet controls, there are some hardware links. These hardware links (wires) connect between the controls to ensure all controls (including ignition) work in unison.

They perform as a redundant check of the minibus reported state. This prevents errant behavior if the boiler is not set up properly.

## (2) Heat Exchanger Wiring

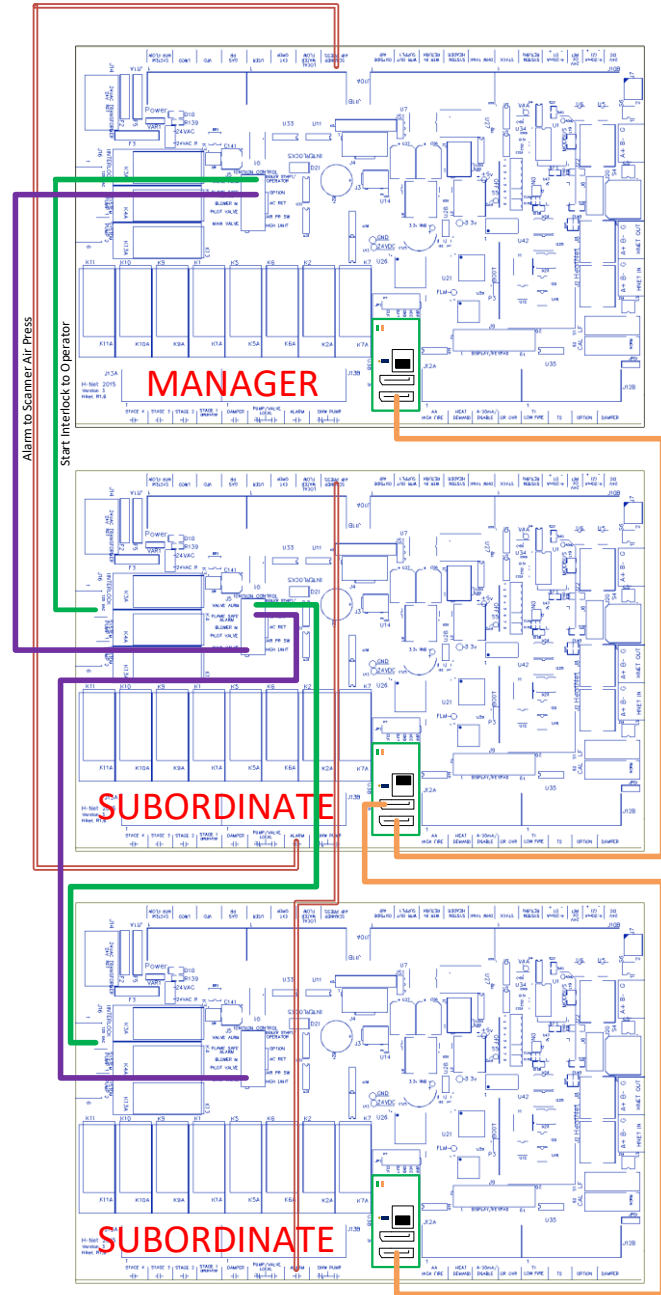


The starting interlock string (120VAC) connection from the front heat exchanger on the ignition control is wired from terminal 6 (J5 Boiler Start) to HeatNet control J16.2. This connection ensures that the middle and rear heat exchangers can't start unless the Manager starts.

The J5 Option connection on the Manager is wired to the Main Valve signal on the rear exchanger. If a third heat exchanger is present, the third (rear) heat exchanger's Main Valve is wired to the middle control's J5 Option input (daisy chain). This connection is to ensure that the Manager knows that the other Heat exchangers have their main valves open. This method performs as a redundant check of the minibus state.

The Scanner Air Press input on J11B of the Manager is wired to the Alarm contacts of J13B of the middle/rear (or first subordinate boiler). If 3 heat exchangers are present, the last subordinate or rear heat exchanger's Alarm contacts are wired to the Middle heat exchanger's Scanner Air Press input (daisy chain). This is to let the Manager know of a fault on the subordinates and also provides a redundant check of an alarm condition of the minibus state.

## (3) Heat Exchanger wiring



Also, ensure that the termination switch S1 on the Minibus board, is set as shown in the drawings. The end heat exchangers have the switch down (ON) and the middle exchanger has the S1 termination up (OFF).

# HeatNet Online

HeatNet Online is a web based system for fault notification, monitoring and tuning of a HeatNet based system. A HeatNet Online bridge module is required to connect a boiler (Usually the Master boiler) to the internet. The bridge is available for version 2.x and version 3.x HeatNet controls and is standard on V3.x. The bridge module provides an RJ45 connector for access to the internet. If an RJ45 hardline is not available, a wireless modem can also be used. Consult the factory or sales for available solutions. The HeatNet Online site may be accessed at: [www.heatnet.net/](http://www.heatnet.net/).

A login Account/Password is required.

Once a user has registered a site, the users email can be set up to provide daily status messages and fault/alarm emails within minutes of trouble. This provides a valuable tool for technicians on the road. If the technician has a smart phone, they can be notified through the emails on their phone. They can then log on to the HeatNet Online website (from their phone) to determine the trouble. Sample email message:

### HeatNet Online Alert

CK 1500	Fault	High Limit	May 17 2014 11:09AM	WVHID99999	View Alert Data
---------	-------	------------	---------------------	------------	-----------------

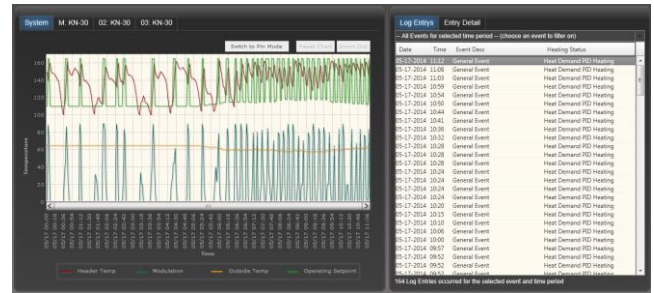
Once the user has logged in, a selection screen for the building sites the user has registered will be displayed. When a building site is selected, the Main Live screen will be entered. This is the HOME screen and provides a quick view on the status of the site.



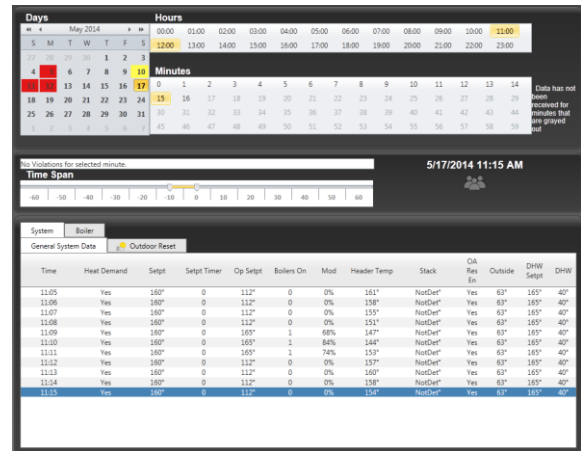
Selecting the History tab allows a runtime Histogram of the system. The histogram displays temperatures and states of

the system in a date/time format. Also displayed is the Master boiler log, faults, messages, modulation, and events. To the right of the histogram is the Master Boiler's log. Since the HeatNet bridge only transmits at 1 minute intervals, the log can be used to precisely view the state of the boiler at the time of the event (in-between minutes).

This screen is an excellent way to diagnose system problems and tune systems for optimal performance.



Data Points can also be viewed in a manner other than a histogram as pictured below. The date/time picker can be used to mine the raw data stored on the HeatNet Online server.



Runtime graphs of each boiler ensure even runtimes are being observed by a properly operating system.



This is just an overview of HeatNet Online and a few of the screens that are available.



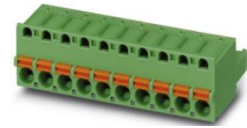
# Wiring Connections

Figure 48 Dip Switches and Wiring

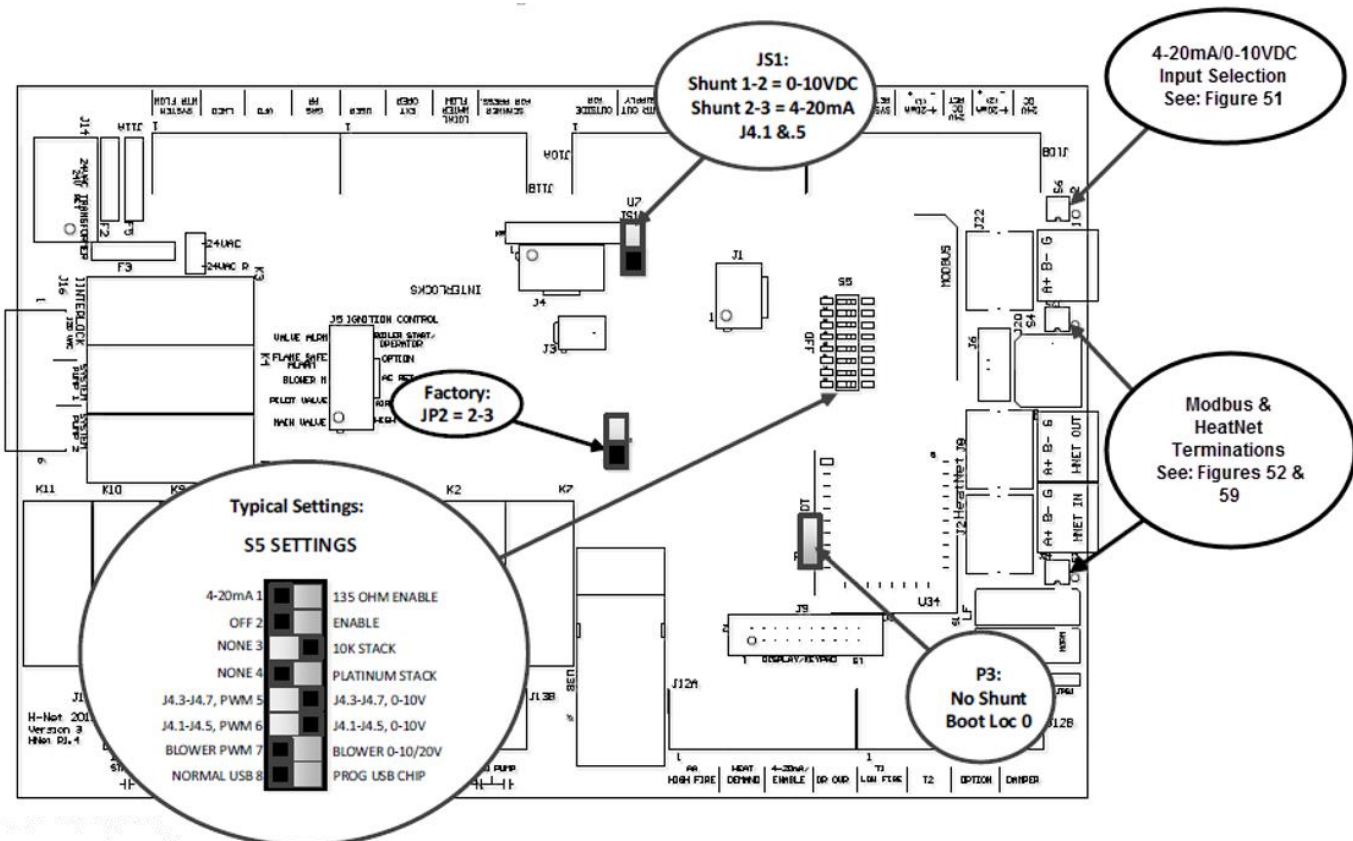
Wire Strip Length.



If the terminal blocks are of the **screwless** type, the wire should be stripped to **.42” or 10.67mm**.

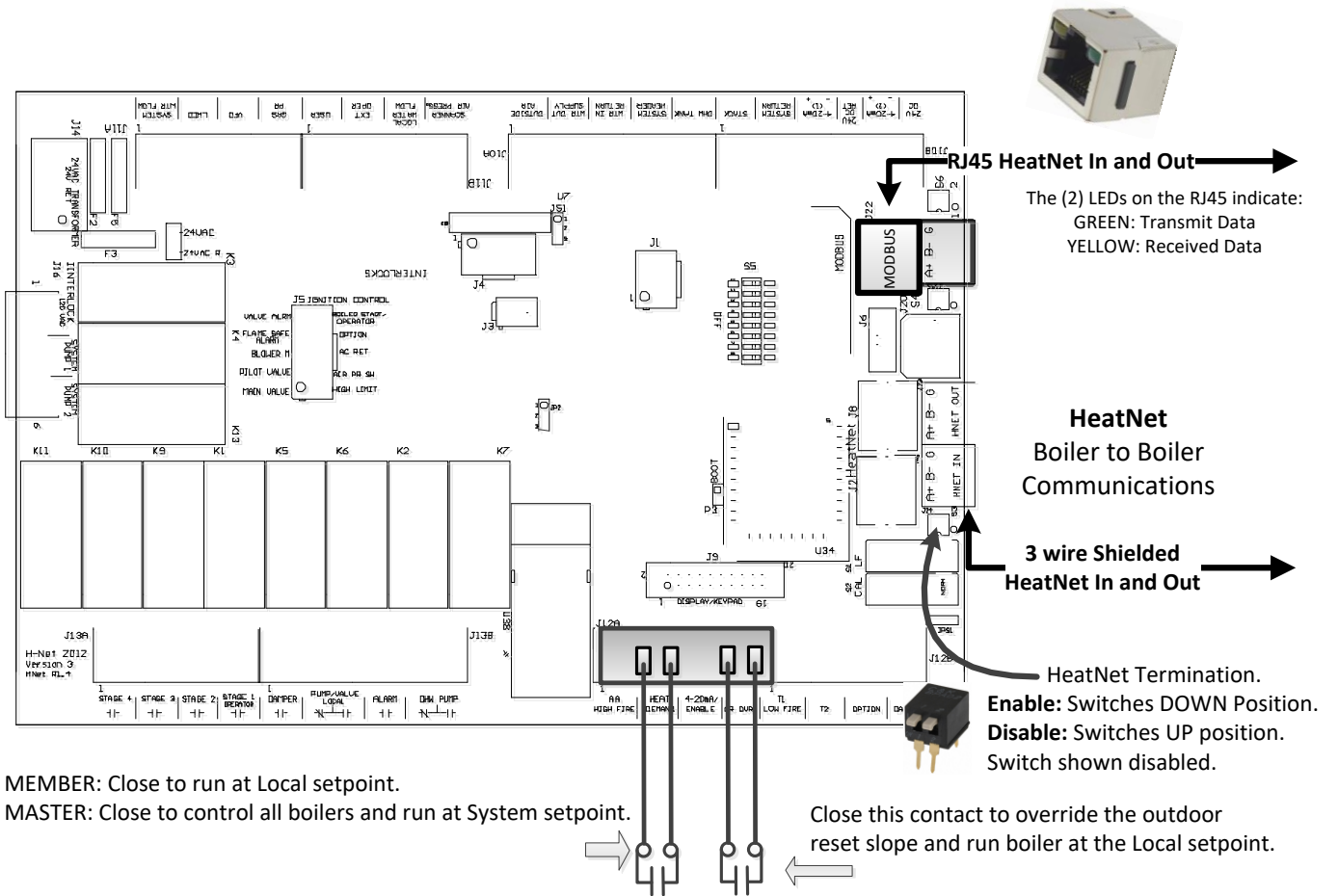


If the terminal blocks are of the **screw** type, the wire should be stripped to **.25” or 6.34mm**.

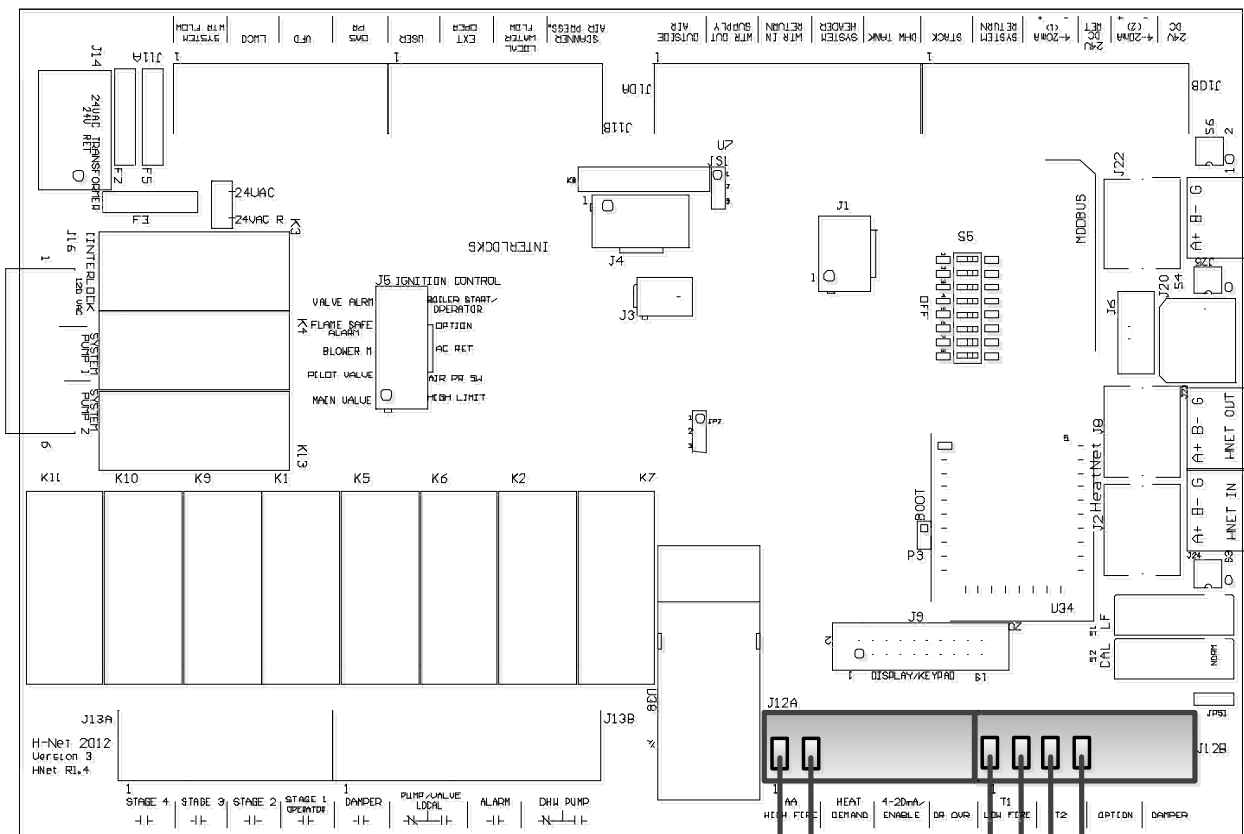


- S5 Dip switches 1,5,7,8 set the Outputs of the J4 Connector.
- S5.1) Set to position 4-20mA for J4.1+ and J4.5- 4-20mA current mode (JS1 = 4-20mA). Set to position 135 Ohm for J4.1(W), J4.7(B), and J4.5\* 135 Ohm mode (JS1 = 4-20mA). **NOTE: S5.6 must be set to J4.1-J4.5, 0-10V for the above to work in 4-20mA mode. If JS1 is set to 0-10VDC then this switch has no effect on J4.1 and J4.5.**
  - S5.2) NOT USED (Factory)
  - S5.3) Set to NONE if there is no Stack Sensor or if a 1k Platinum stack sensor is used. Set to 10k STACK, if a 10k Thermistor stack sensor is connected to J10B.
  - S5.4) Set to NONE if there is no Stack Sensor or if a 10k Thermistor stack sensor is used. Set to PLATINUM STACK, if a 1k Platinum stack sensor is connected to J10B.
  - S5.5) Set to J4.3-J4.7, PWM, Configures J4.3+ and J4.8- for PWM output Set to J4.3-J4.7, 0-10V, Configures J4.3+ and J4.8- for 0-10 VDC output
  - S5.6) Set to J4.1-J4.5, PWM, Configures J4.1+ and J4.5- for PWM output (JS1 = 0-10VDC). Set to J4.1-J4.5, 0-10V, Configures J4.1+ and J4.5- for 0-10 VDC or 4-20mA output (JS1 = 4-20mA or 0-10VDC). This switch in conjunction with S5.1
  - S5.7) Set to BLOWER PWM for Ametek Blowers. Set to BLOWER 0-10/20V for VFD controlled blowers.
  - S5.8) Set to NORMAL USB = Normal operation Set to PROG USB CHIP (FACTORY ONLY)

**Figure 49** Heating Method 1 H-Net, Master/member



**Figure 50** Heating Methods 2 and 4: AA-High Fire and High/Low, Master or member boiler



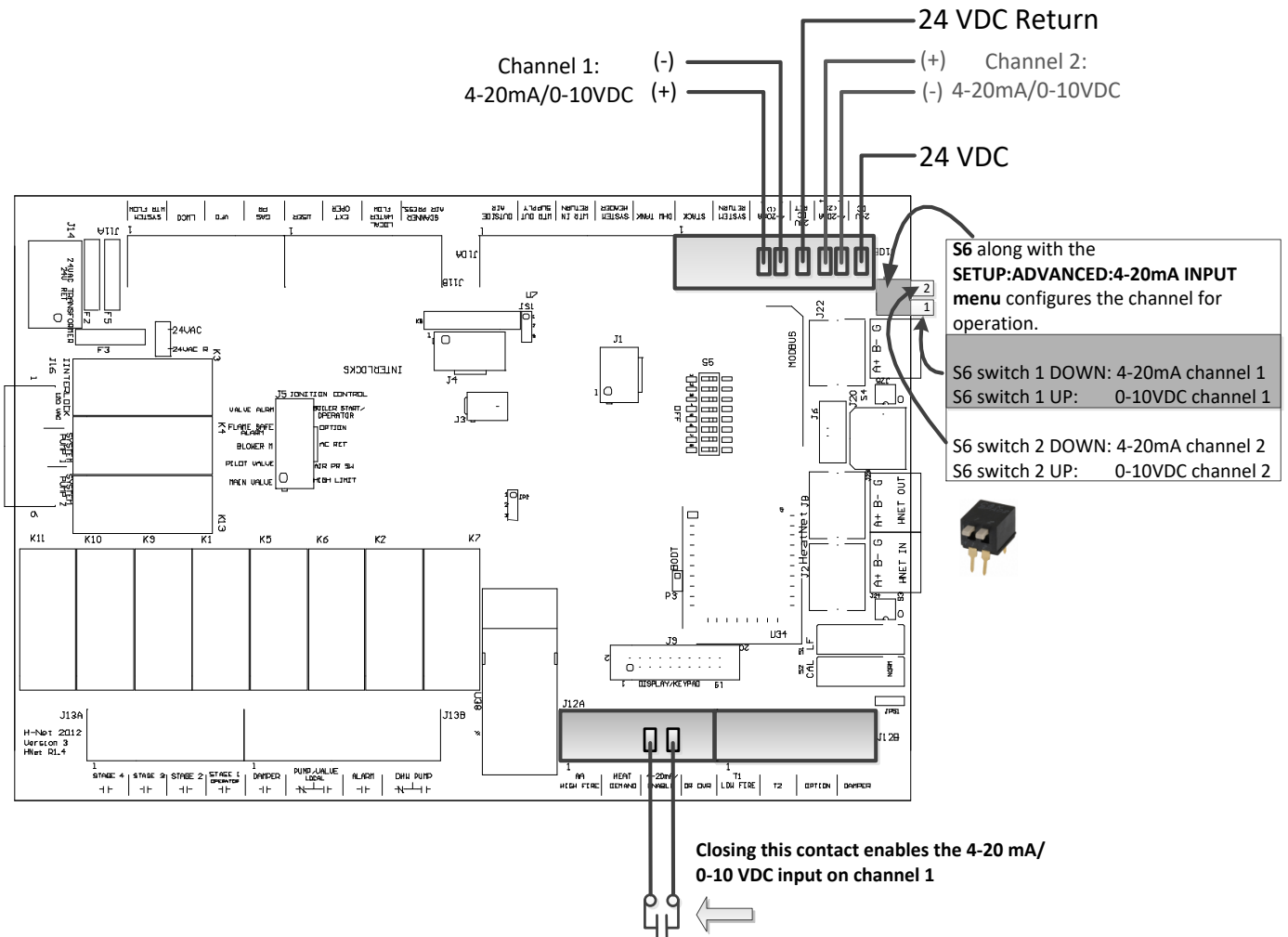
**Heating Mode 4: High Fire**  
Close this contact to run boiler at Highfire.



**Heating Mode 2: Stage Control Inputs.**  
T1 or T2 Closed: Lowfire  
T1 & T2 closed: Highfire



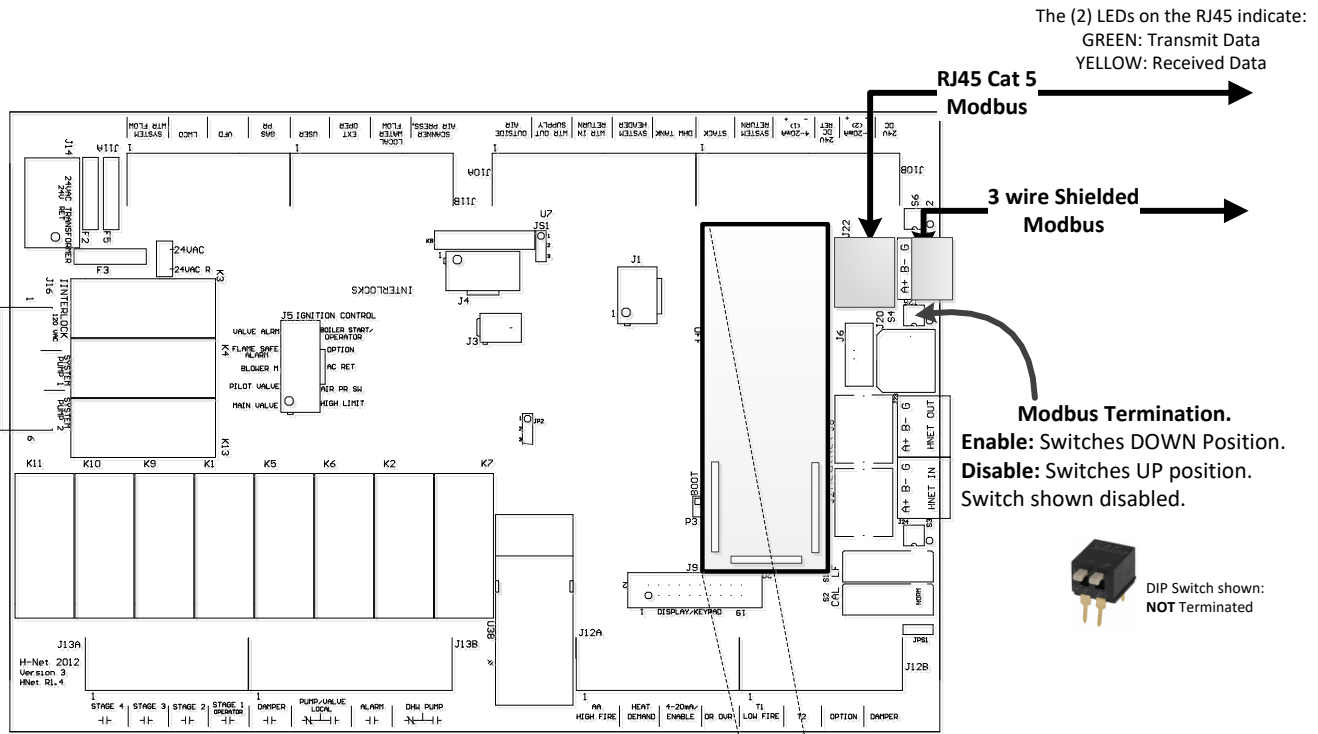
**Figure 51** Heating Method 3 4–20 mA/ 0-10 VDC



This Method allows direct modulation of the boiler based on a 4-20 mA control signal. A control capable of transmitting a 4-20mA/0-10 VDC control signal for the purpose of modulating a boiler and to control a common system temperature must be used with this method.

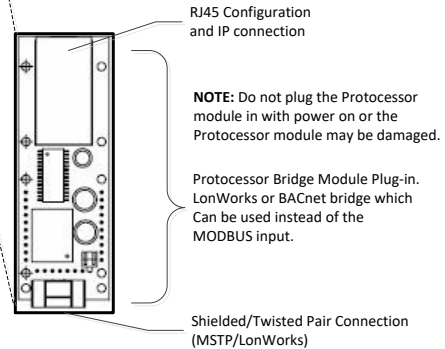
**NOTE:** If using a 0-10 VDC signal multiply any references to current in the manual by .5. Example: 5ma \* .5 = 2.5 VDC

**Figure 52** Heating Method 5: MODBUS (Optional BACnet or LonWorks bridge — Processor)



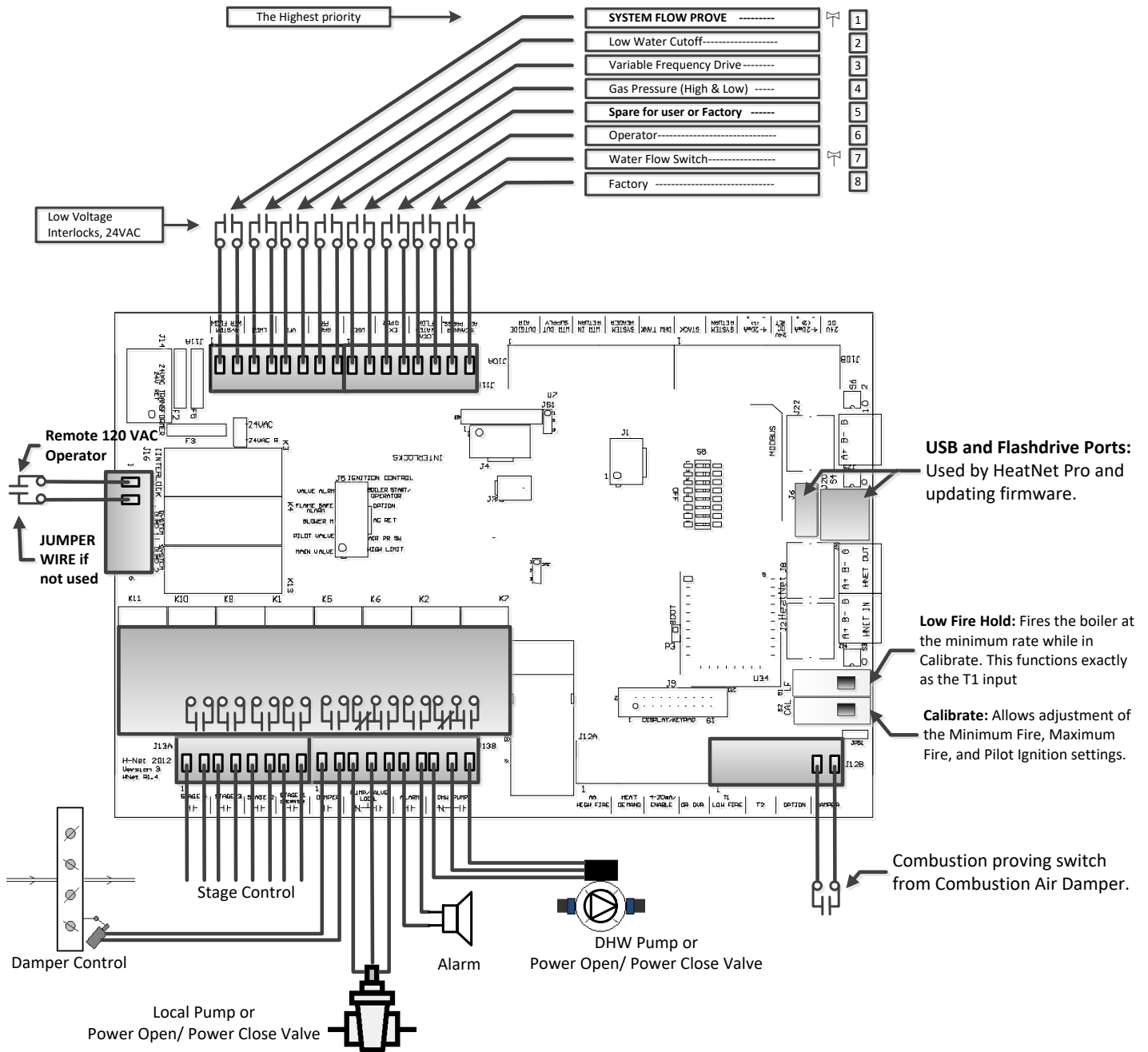
The pin headers are located on the control ('U' shaped) that the Protocessor bridge module plugs in directly. Align the sockets on the Protocessor with the pin headers on the control, then press into place. Communication from the Protocessor bridge to the H-Net control is also handled through the sockets.

Next, connect the BACnet or LonWorks network cable to the Protocessor module or configure the bridge using the software tools. Once connected use the DIP switch to enable termination.

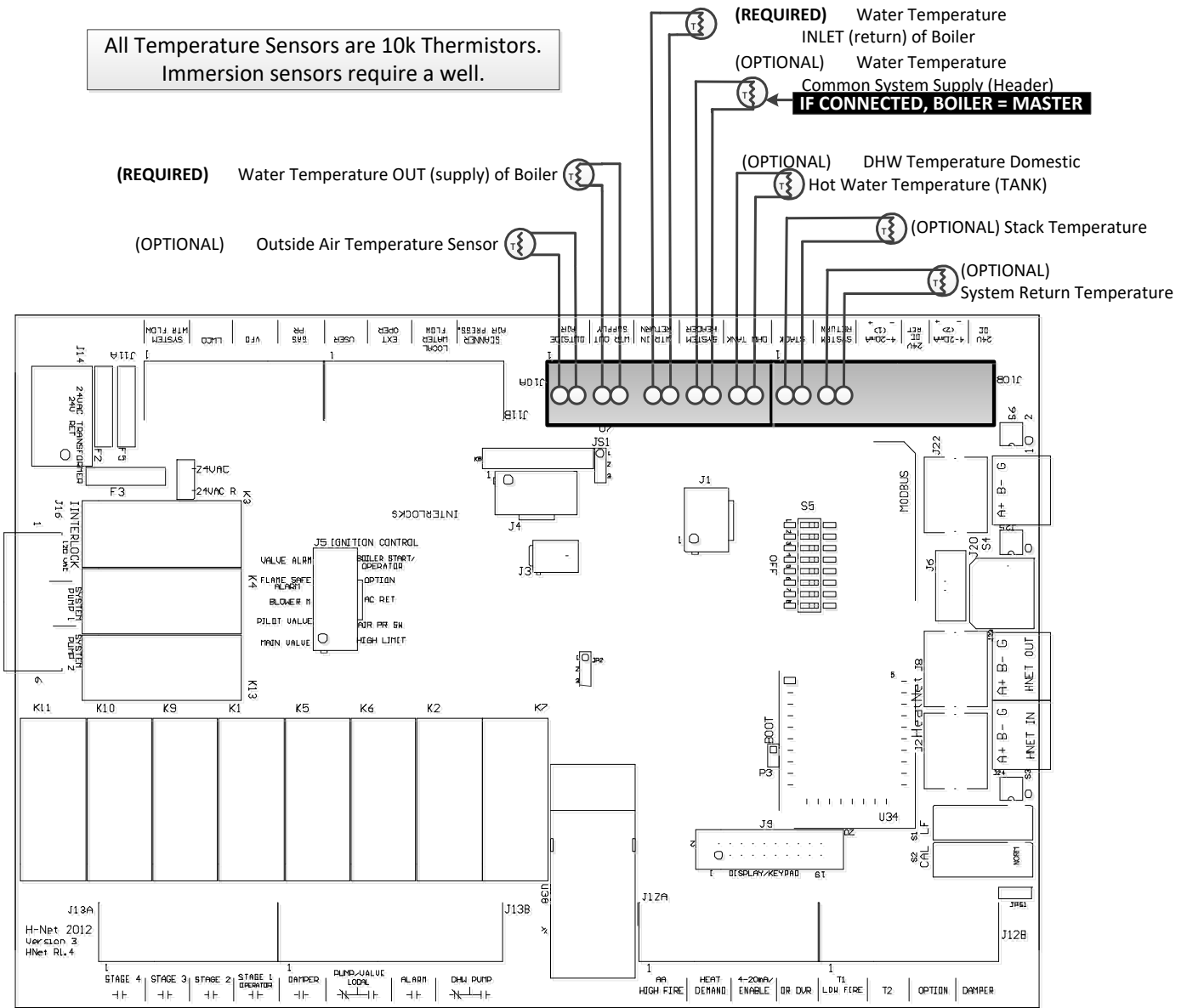


**Additional Bulletins and Instructions for Configuring BACnet or LonWorks are available on the website.**

Figure 53 Relays, Interlocks and Boiler Status



**Figure 54** Temperature sensors



**Figure 55** FlexCore Minibus

The Version 1.6 HeatNet board requires Minibus connections for FlexCore boilers with more than (1) heat exchanger. The Minibus requires a serial data cable between each HeatNet Control board. The first and last Heat Exchanger must have the minibus terminated for the bus to work properly. S1 would be placed in the ON position as indicated below for the front and rear heat exchangers. The jumper, JS1 must always be in the position indicated (closest to S1). It is used for testing.

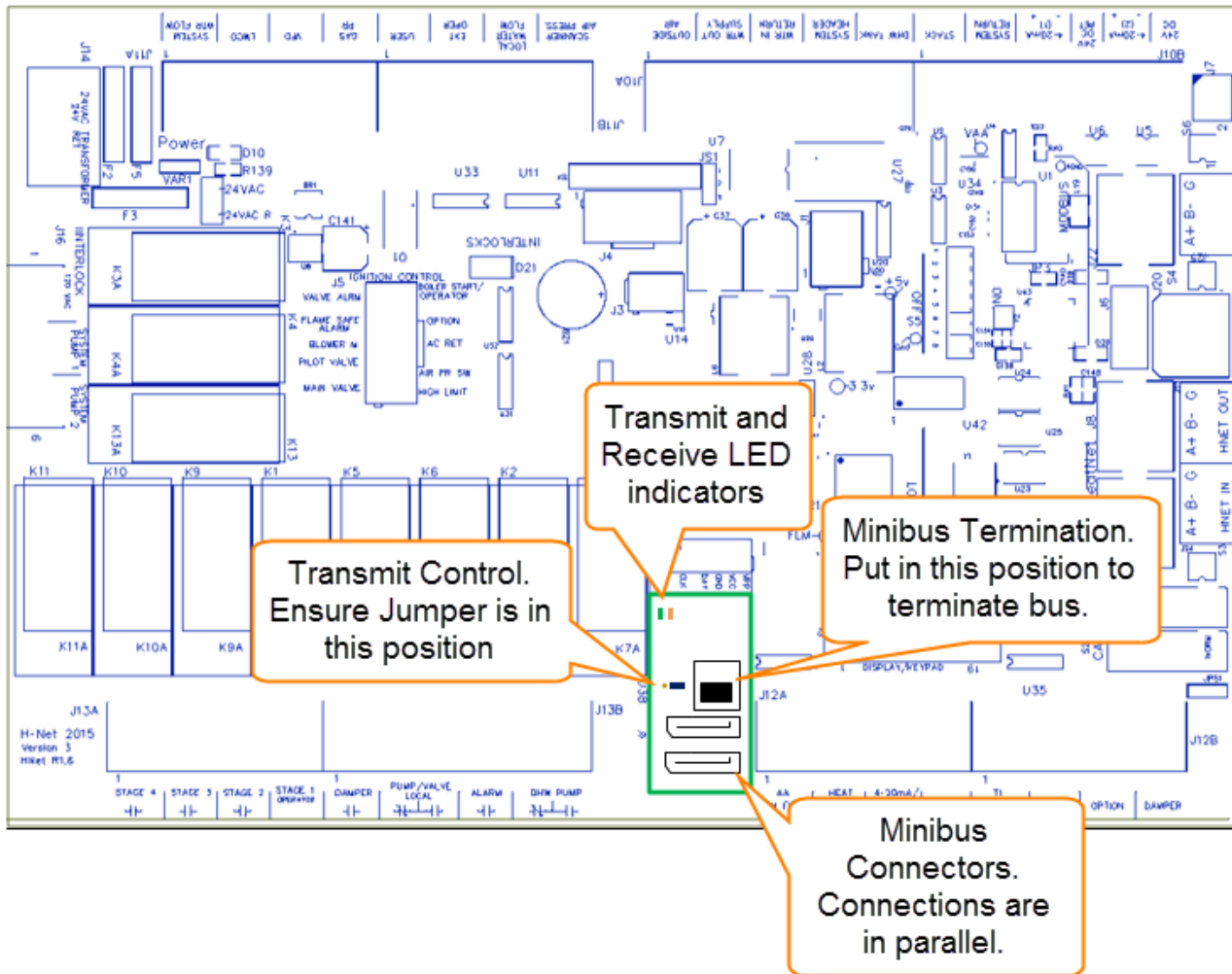
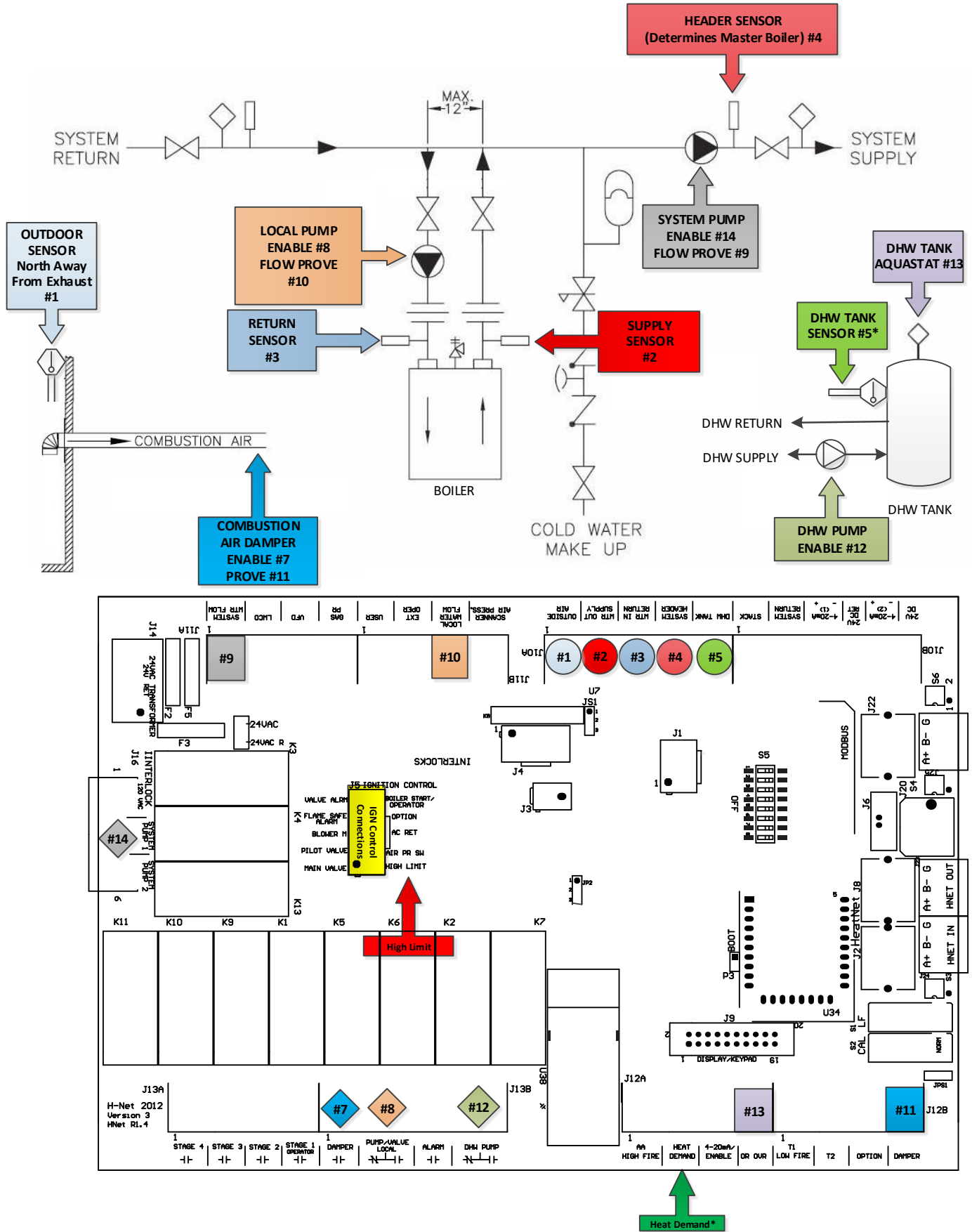
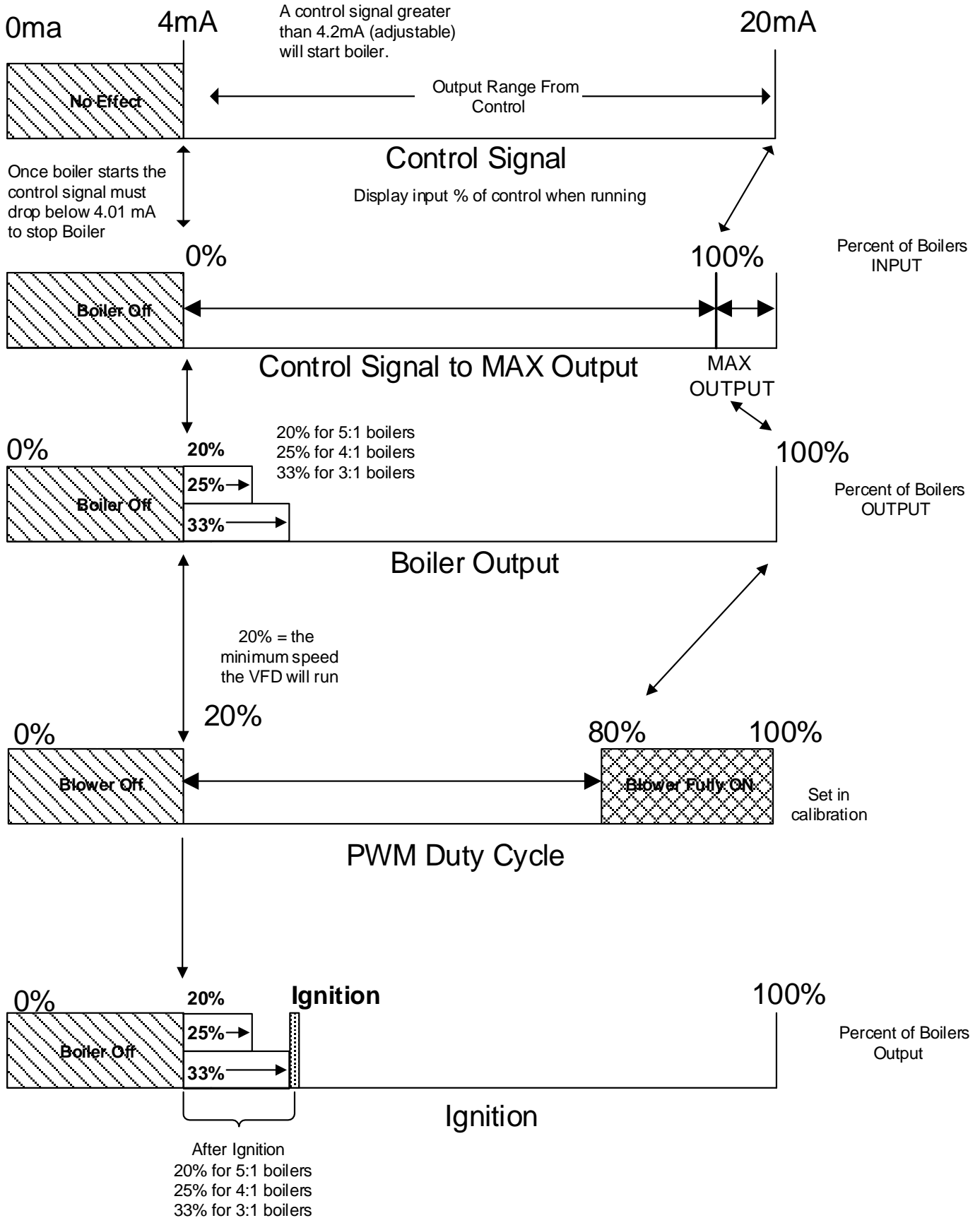


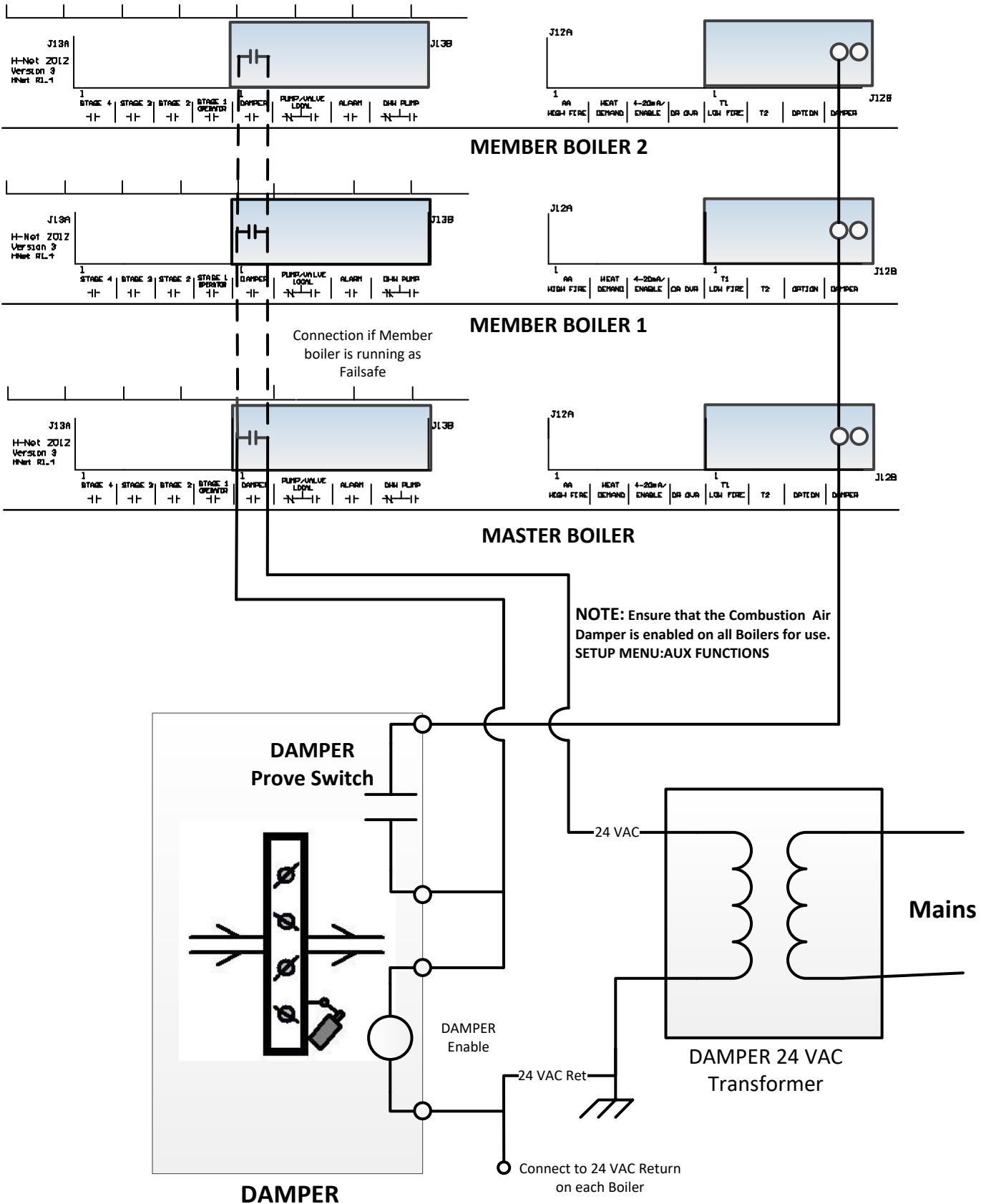
Figure 56 Typical Single Boiler System



**Figure 57** Using a 4–20 mA signal for direct modulation

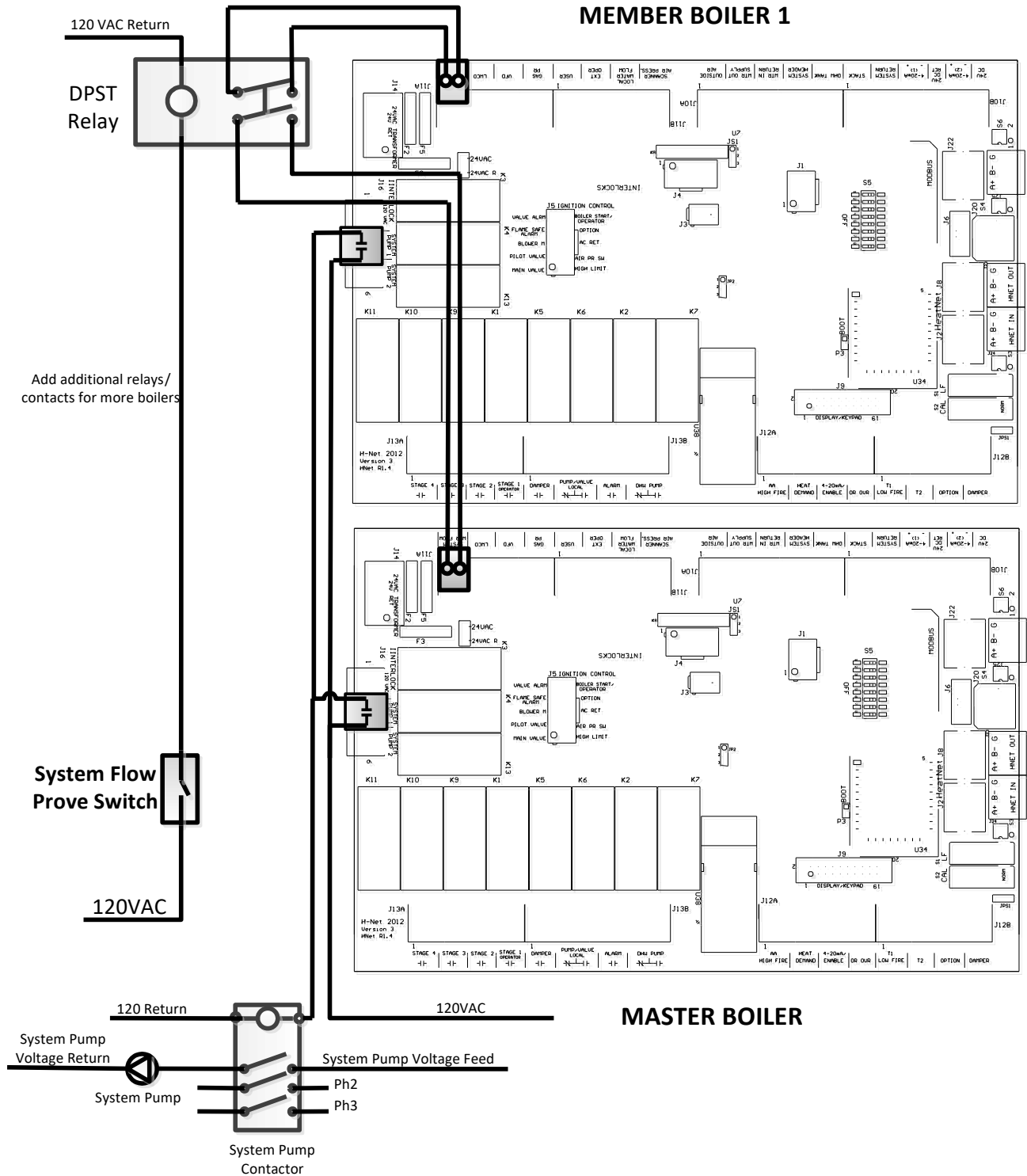


**Figure 58** Common system damper wiring

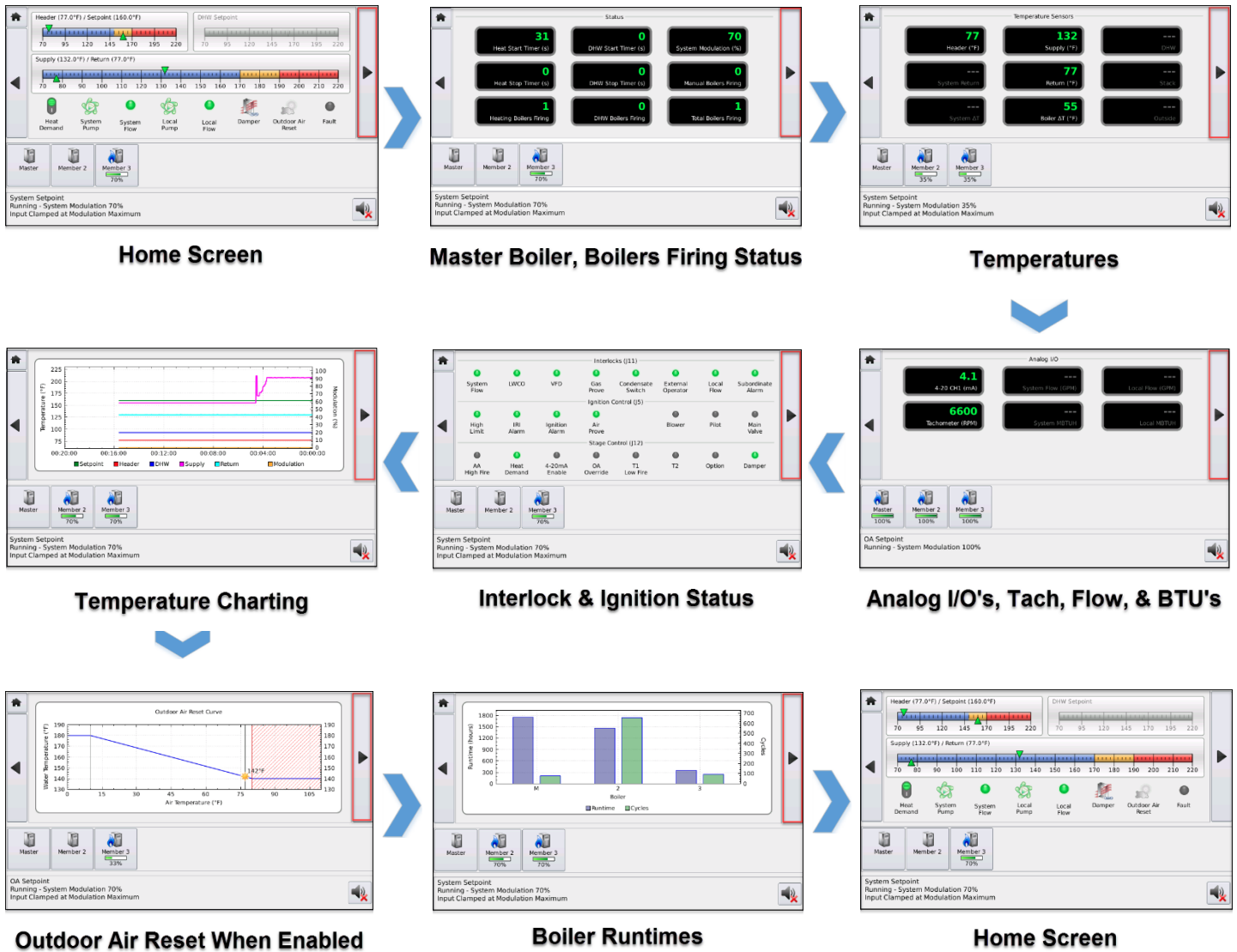




**Figure 59** Failsafe common system pump wiring



# Home Screen Navigation



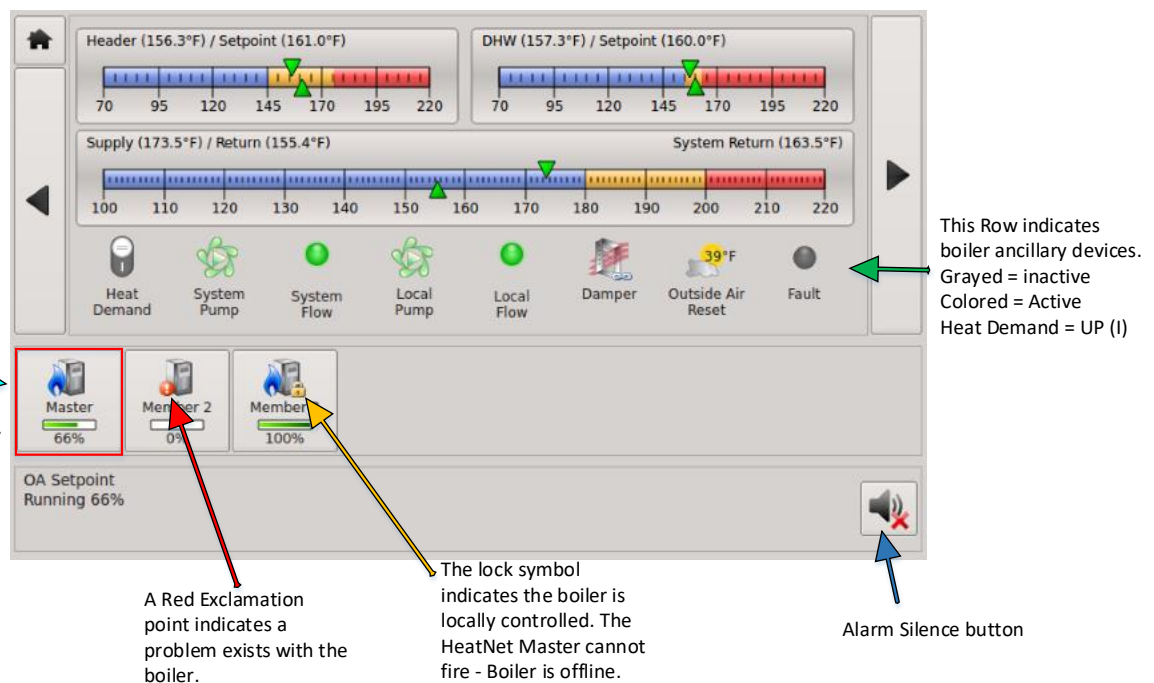
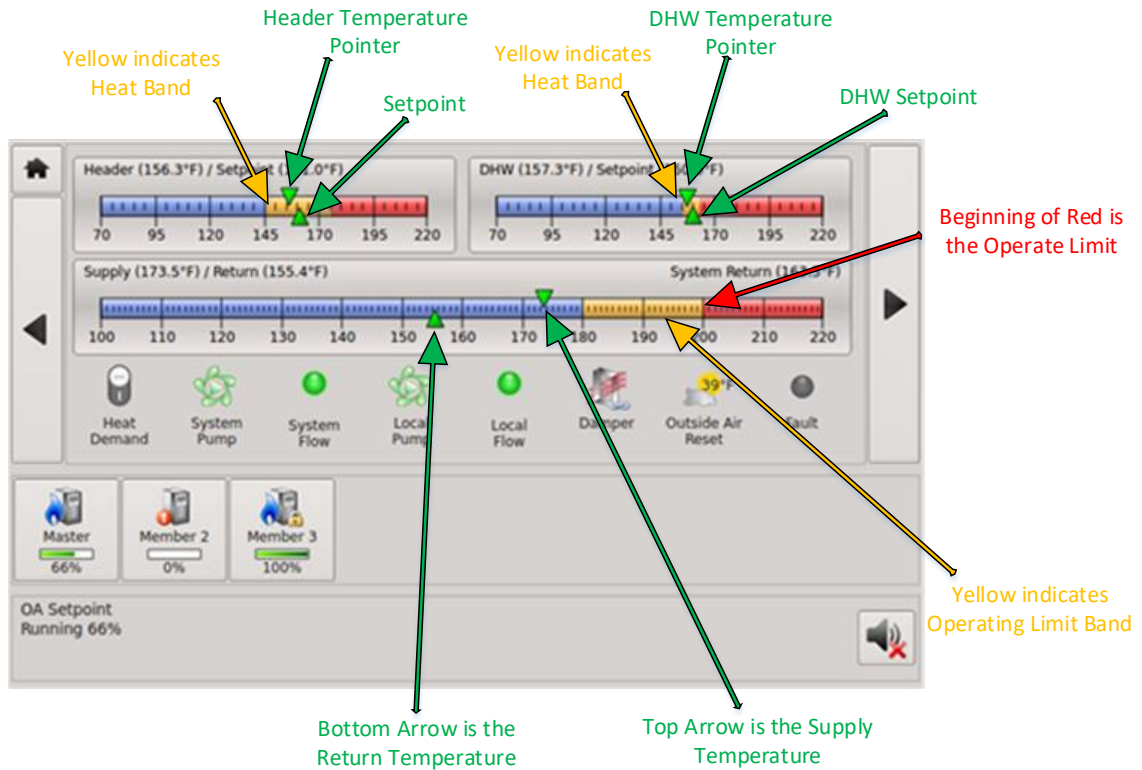
This diagram depicts the Home screen and subsequent screens when the right arrow button is pressed. Repeatedly pressing the right arrow button forms a ring of the different screens. These screens are used during normal operation of a boiler or boiler system.

# Home Screen

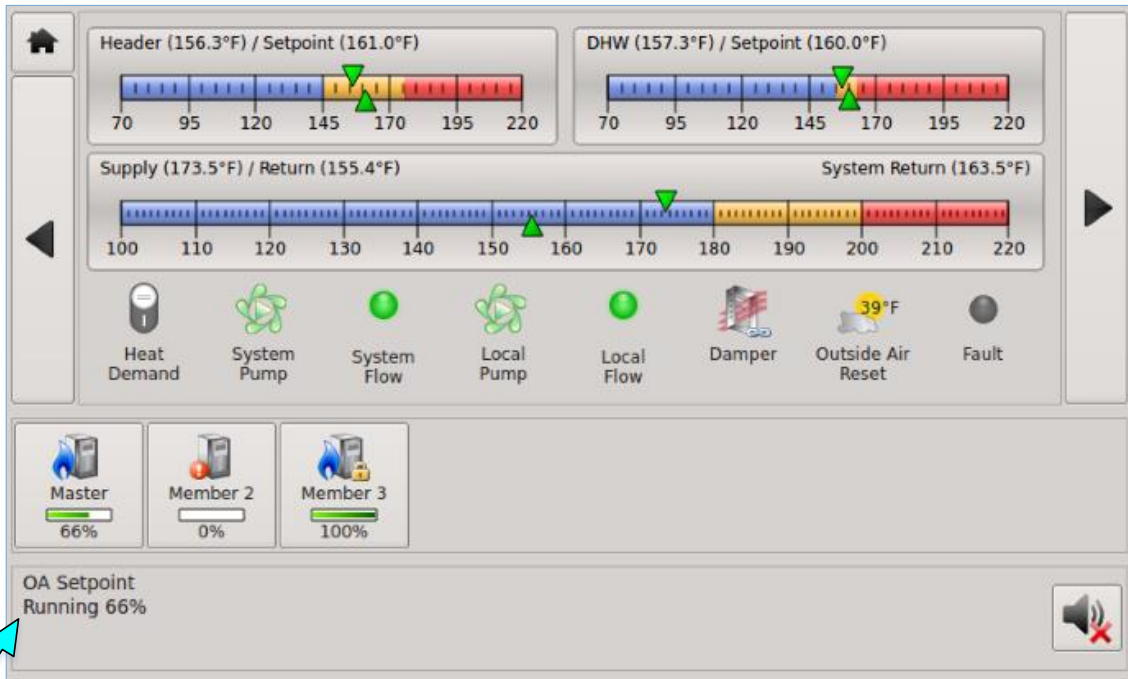
The Home screen is used to show the main temperatures in graphs along with some ancillary functions.



The Home Button in the upper left corner when pressed, will always enter the Home screen.



# Home Screen Messages



Status Line 1: Setpoint Source – Heating Mode  
 Status Line 2: Running Status  
 Status Line 3: Any Fault Information

## Heating Mode Messages

<b>Control Signal</b>	An analog control signal on 4-20mA (1) input is controlling fire rate.
<b>DHW Tank</b>	A DHW thermostat or sensor is being used to fire boiler in a DHW mode.
<b>Failsafe</b>	Boiler in Failsafe mode – No other Heating Demand may be present.
<b>HeatNet</b>	Call for Space Heat is controlled by HeatNet.
<b>HeatNet DHW</b>	Call for DHW Heat is controlled by HeatNet.
<b>High Fire</b>	High Fire AA is active or T1 and T2 Inputs are active.
<b>T1</b>	T1 Input is active – Low Fire rate
<b>T2</b>	T2 Input is active – Low Fire if T1 Input– High Fire if T1 active

## Setpoint Source Messages

<b>0-10V Setpoint</b>	Settings are configured to allow a 0-10VDC signal to change setpoint.
<b>4-20mA Setpoint</b>	Settings are configured to allow a 4-20mA signal to change setpoint.
<b>DHW Setpoint</b>	The DHW sensor is controlling the setpoint for DHW heating.
<b>Local Setpoint</b>	Boiler is watching the Local Setpoint..
<b>OA Setpoint</b>	The Outside Air sensor is controlling the setpoint..
<b>System DHW Setpoint</b>	A Member boiler is being controlled by a HeatNet Master – Reference.
<b>System Setpoint</b>	Boiler is watching the System Setpoint from the HeatNet Master.

## General Messages

<b>Air Switch (Blower)</b>	If the ignition control closes its BLOWER relay, and the control does not see the PILOT relay close within (2) minutes, this message will be displayed. This alarm protects the boiler from freeze ups being caused by a blower bringing in cold outside air with no fire.
<b>BLOWER, RPM FAULT</b>	The Tach signal on J1 is present or is not present (depending on the Blower Type) when the blower starts it's pre-purge. This may be caused by the Boiler Type setting being improperly set to a VFD when an Ametek blower is present, or an Ametek blower being set when a VFD is present.
<b>BLOWER, RPM HIGH: (Ametek Blower)</b>	If the signal from the HeatNet control board to the Ametek blower exceeds the factory limits, or the blower “runs away” (excessive speed), this message will be displayed. With this event, the HeatNet control will lockout the boiler and the boiler will require a manual reset to restart.
<b>Blower Signal not Received, Retrying</b>	The Boiler attempted to start by sending the J5 FLAME SAFE ALARM signal to the Ignition Control. The control then waited for the Blower signal from the Ignition Control and timed out. The Blow out switch (air box safety relief) may have opened.
<b>Call For Service</b>	When a start signal to the ignition control is sent and not received the H-Net control wait s 2 minutes. A retry start ignition sequence for the duration of the local pump post purge time will occur. During this time ,“ <b>Blower Signal not Received, Retrying</b> ” will be displayed. After (5) attempts the H-Net control will lock out.
<b>Combustion Air Damper Fault</b>	Caused when the damper is detected closed, but should be open . Input on J12B.7 & J12B.8.
<b>DHW Heating</b>	The boiler is performing DHW Heating.
<b>Failsafe: HeatNet Communications Lost</b>	The control has entered the Failsafe mode due to a loss of HeatNet communications from the Master.

<b>Failsafe: Low DHW Temperature</b>	The boiler has entered Failsafe mode due to a low DHW temperature.
<b>Failsafe: Low Header Temperature</b>	The boiler has entered Failsafe mode due to a low Header temperature.
<b>Failsafe: Low Return Temperature</b>	The boiler has entered Failsafe mode due to a low Return temperature.
<b>Failsafe: Low Supply Temperature</b>	The boiler has entered Failsafe mode due to a low supply temperature..
<b>Fault</b>	A problem has occurred with boiler – Interlocks or firmware detected.
<b>Fuel Change (Dual Fuel) is in Progress</b>	If the boiler is configured for dual fuel – displays during a changeover.
<b>Gas Pressure is too High or Low</b>	If the GAS PR opens on J11A.7 & J11A.8 due to a gas pressure issue.
<b>Heating</b>	The system is in a heating mode, but none of the boilers are firing.
<b>High/Low <math>\Delta T</math> limited</b>	Algorithm that looks at High $\Delta T$ or Low $\Delta T$ to protect boiler from thermal shock/stress. When this is displayed firing rate is limited.
<b>Ignition Control Alarm</b>	Occurs when the Ignition Control closes it alarm relay – Input on J5 FLAME SAFE ALARM. The ignition control alarm is displayed if the ignition control detects a fault. This could be a flame failure, air proving switch, or other fault associated with the ignition control. When this fault occurs, you will need to refer to the ignition control for the reason.
<b>Input Clamped at Modulation Maximum</b>	This clamp ensures that until all boilers are running, the input is limited to minimize over firing the system when new boilers are added. It also limits the boiler's input before servicing a request to go to high fire (preventing thermal shock).
<b>Input Clamped for Protection (Operating Limit)</b>	This clamp is active when the supply water temperature is in the Operating Limit Band (Yellow part of the Heating bar). It is used to limit the input of the boiler in order to minimize cycling off the Operating Limit.
<b>Input is limited to ½ rate</b>	The boiler is in a protection mode, High/Low Delta – firing rate limited.

<b>Input is Reduced due to Stack Temperature</b>	If a stack sensor is used and temp exceeds limits.
<b>IRI Alarm</b>	This is a 120VAC interlock used by the Gas Valve proving option. J5 Input VALVE ALARM.
<b>Minimum off Time is Active</b>	The Minimum Off Time has been set on the boiler. During this time the boiler has taken itself offline from the Master.
<b>Multiple out of Sequence Interlocks Fault</b>	The HeatNet control has detected an interlock fault and is trying to resolve the source. A wait period is in effect.
<b>New Boiler Starting, Reducing Input</b>	In a HeatNet system with the Adaptive Modulation selected, the boiler will reduce input on currently running boilers when starting a newly added boiler. This is to minimize adding too many BTUs delivered to the system.
<b>No Local Flow</b>	Interlock LOCAL WATER FLOW on J11B.5 & J11B.6. Once the HeatNet series boiler receives waits 10 seconds or more (adjustable) to prove flow. If there is no flow, the flow switch alarm will be set. Every 10 minutes the circulator pump relay will cycle ON for 10 seconds and then OFF for 10 seconds to try and establish flow..
<b>No System Flow</b>	The SYSTEM WTR FLOW interlock is open. J11A.1 & J11A.2. Once the HeatNet series boiler receives a call for heat, it closes the system circulator pump relay. It then waits 10 seconds or more to prove flow. If there is no flow, the flow switch alarm will be set. Every 10 minutes the circulator pump relay will cycle ON and then OFF for 10 seconds to try and establish flow.
<b>Number of Boilers Limited due to Insufficient Flow</b>	The GPM measured through a system flow meter, writing the GPM through communications port, or writing the # of boilers that can run does not meet flow requirements.
<b>OPEN *** Sensor</b>	The *** indicates the temperature sensor which opened. Sensors are: Outside, Supply, Return, Header, DHW, Stack, and System Return.
<b>Pre-Purge</b>	The Blower is exchanging the air in the combustion chamber per the Ignition control's pre-purge time.
<b>Pilot</b>	The boiler is at it's ignition phase in attempting to light the pilot.
<b>Post Purge</b>	A post purge of the blower is in effect.
<b>Return Temperature is Low</b>	Displayed when the Return Temperature may cause condensing (mainly in non-condensing boilers).

<b>Running</b>	The boiler is running and heating water. The Main Valve is open or this is the called for % of input.
<b>Running 100%</b>	The boiler is calling to run at 100% modulation.
<b>Shorted *** Sensor</b>	The *** indicates the temperature sensor which has shorted. *** Sensors are: Outside, Supply, Return, Header, DHW, Stack, and System Return.
<b>Stack Temperature is High</b>	If a 1k ohm platinum stack sensor is used, this message will be displayed . Caused by poor heat transfer in the exchanger.
<b>Standby</b>	The boiler has no call for heat. There is no Heat Demand Input.
<b>Subordinate Alarm</b>	An Alarm condition has been detected on a subordinate boiler (FlexCore with multiple heat exchangers). This Alarm condition may have been detected by the Minibus or through the Scanner Air Press input in the interlock string.
<b>Supply Water Temperature has Exceeded its High Limit Setting</b>	The Mechanical High Limit on the Boiler has tripped. The high limit interlock breaks power to the ignition control and effectively removes any chance of the gas valve receiving power. The HeatNet series control remains powered to record and display the fault.. The interlock is located on J5, HIGH LIMIT. Ensure power is present on the input to the High Limit Control.
<b>Supply Water Temperature has Exceeded the Operating Limit</b>	When the supply water temperature exceeds the top of the Operating Limit Band and the Operating Limit. This is the Yellow Band portion of the temperature bar on the Home Screen.
<b>Supply Water Temperature has Exceeded the Stat Operating Limit</b>	The system is in a heating mode, but none of the Displays when a mechanical thermostat input is used and connected to EXT OPER J11B.3 & J11B.4 and opens.
<b>User Interlock</b>	This may be used as a custom interlock input on J11B.1 & J11B.2, but is currently used on FlexCore boilers as a float switch at the bottome of the heat exchanger.
<b>UV Air Pressure Switch is Open</b>	Input on J11B.7 & J11B.8 SCANNER AIR PRES. Boiler will still, though the site glass for the UV flame Scanner may become fogged during lower firing rates. This may lead to nuisance flame failures.
<b>UV Shutdown Test</b>	If the boiler runs continuously for a 24 hour period, the boiler will be cycled off and restarted to test the UV flame detector.
<b>Variable Frequency Drive Alarm)</b>	If a VFD is used to control blower speed , this message shows when the VFD's fault relay opens across J11A5 & J11A.6. The variable frequency drive, which controls non Ametek blowers, reports this fault. It may be caused by an over current, or an internal VFD fault that would cause it to shut down. If this is the case, check the fault indicators on the VFD.

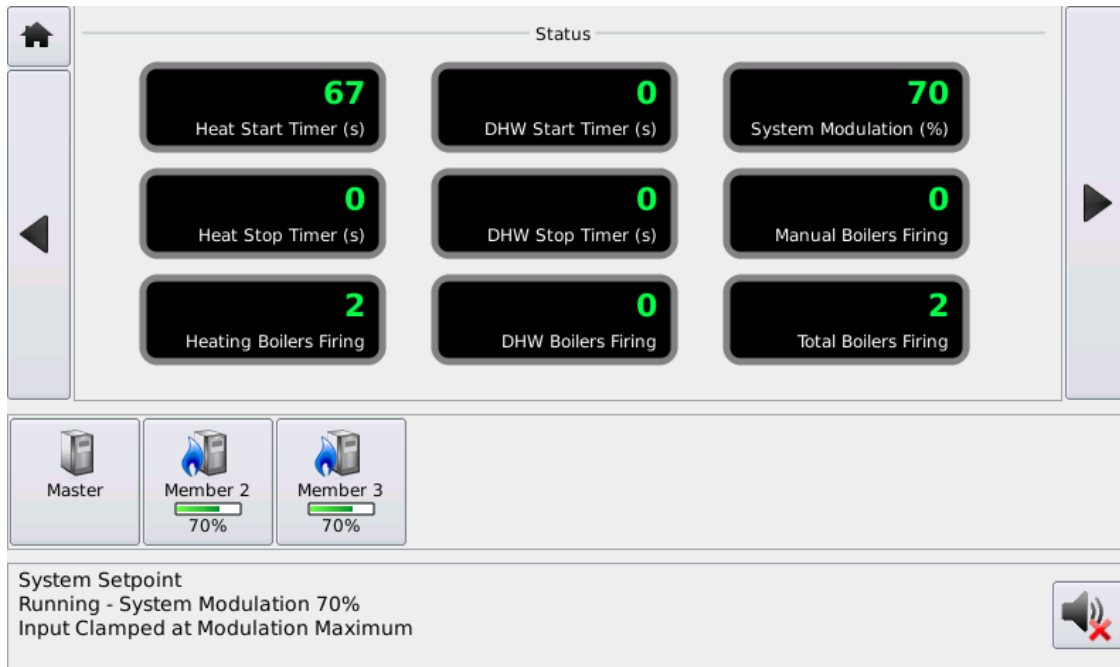


---

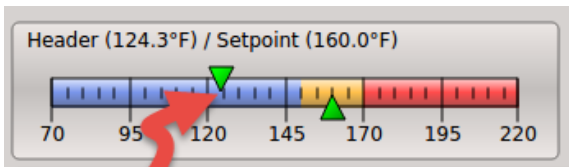
<b>Waiting for Damper to open</b>	This is the Damper proving time when the damper relay closes until the Damper prove interlock closes on J12B.7 & J12B.8.
<b>Waiting for Flow</b>	This is the flow proving period that is in effect when starting the boiler. The pumps/valves would have been called on prior to this message. It's time may be extended using the flow prove time..
<b>Waiting for Start Sequence</b>	The boiler has begun to start and is waiting for the handshaking events to begin with the ignition control and the HeatNet control.
<b>Warm Weather Shutdown in effect</b>	The WWS temperature has been exceeded. The boiler system is in a sleeping state, but can be awoken with a DHW call. Once the outside air temperature falls below the WWS temperature, normal space heating will restart.
<b>Warning</b>	This message, unlike a Fault, still allows the boiler to function, but the issue should be serviced.
<b><math>\Delta T</math> has Exceeded its Limit</b>	The delta temperature across the boiler is too high
<b><math>\Delta T</math> has Reached its Warning Limit</b>	The $\Delta T$ WARNING has been selected instead of FAULT when the Delta T has been exceeded.
<b>Low Fire Shutdown</b>	When a call for heat has ended, and if the firing rate was greater than 50%, the boiler will drop to low fire and run for one minute before shutting off.

---

## Master Boiler Status Screen

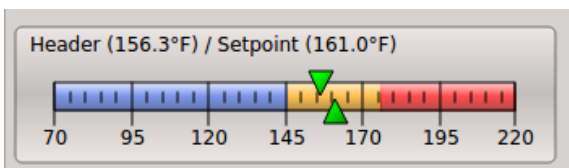


The above screen on the Master boiler displays the start and stop timers that are used to bring on boilers below and shed them above the heating band. When the Header temperature is below the band, the Heat Start Timer (Add Boiler Delay Timer) is started. Once it reaches 0, the next boiler will fire and be added to the Boilers firing display. This will continue until the Header temperature enters the Heating Band (Yellow) or all boilers have fired.



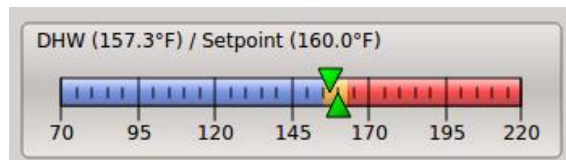
### Heat Start Timer (ADD BOILER DELAY)

When the Header temperature is above the band (Yellow), the HEAT STOP TIMER (Shed Boiler Delay) is used to stop/shed boilers.



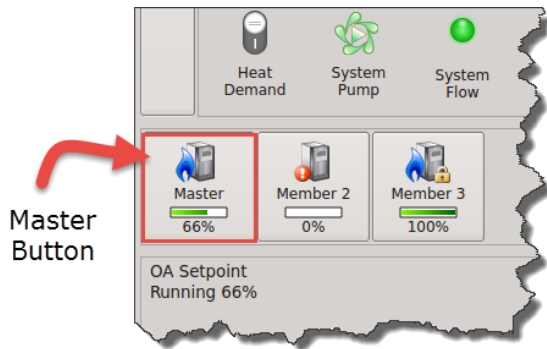
All boilers running are modulated to maintain Setpoint. Boilers are not added or shed while in the heating band (Yellow), except for when Predictive Start is set to YES.

If Predictive Start is used, and when the temperature is falling fast through the band, a boiler will be started when in the band. The same use applies to the DHW Start Timer (Add Boiler Delay) and DHW Stop Timer (Shed Boiler Delay) for DHW heating.

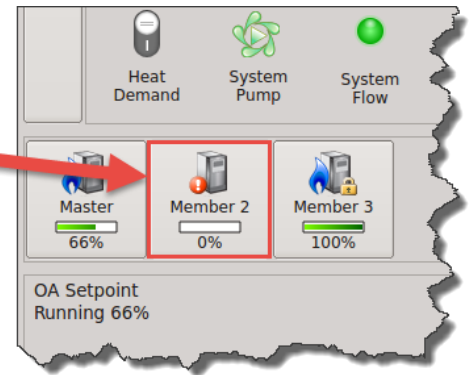


The remaining Status screens are informational and self-explanatory. These include: Temperature Sensors, Analog I/O, Interlocks - Ignition Signals – Stage Control inputs, Graphing, OA Curve, and Runtimes.

On the Home screen, information on each boiler can be accessed by pressing a boiler's button.

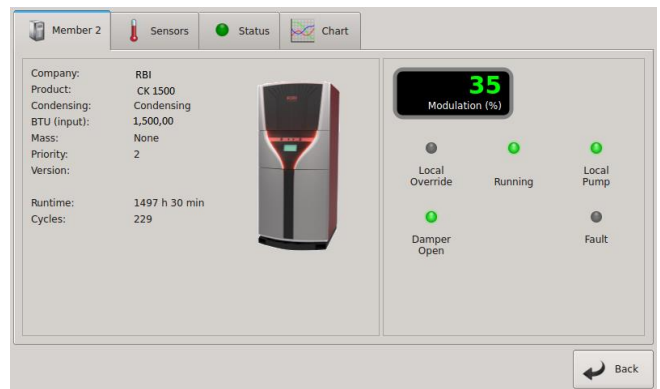


Member Button



Pressing The Master boiler's button will bring up the Master's information screen. Information about the boiler is displayed. Next to it is the Log File button. Pressing this button will allow viewing of the log file. See Log Entry section.

Pressing any of the Member buttons will bring up a Member's informational screen. Limited information is available for a Member from the Master boiler, including making Settings changes and the Log. These need to be viewed on each Member boiler directly.

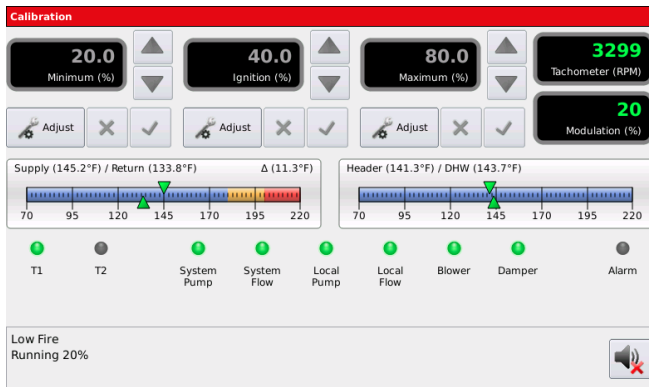


# Calibration

**NOTICE** The calibration of the FlexCore CK Series boiler should only be performed by a licensed/Certified technician.

All calibration settings should be adjusted based on the boiler's parameters. See the Boiler Installation, Operation, and Maintenance manual (IOM).

To enter the calibration menus, place the S2 switch on the main control board to the CAL position. A reloading message will be displayed and then the calibrate screen.



Be sure to set this switch back to NORM when the calibration is complete, otherwise no external control inputs will work (except T1-T2), the display will always indicate CALIBRATE and some of the runtime temperatures will not be displayed.

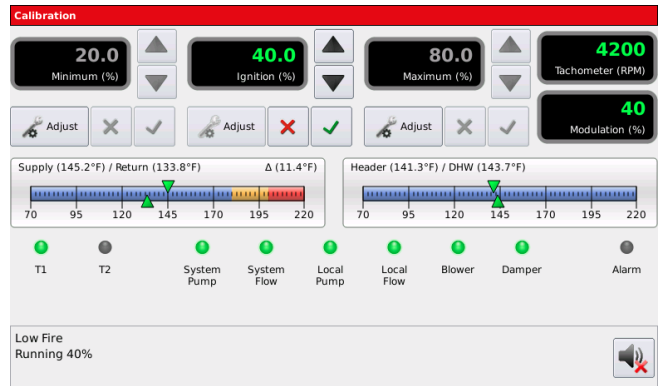
The MINIMUM (%), MAXIMUM (%), and the IGNITION (%) settings can be adjusted from the calibration screen. The values can be changed while running **ONLY IN MINIMUM FIRE** (any, but only one, of the T inputs closed). Prior to ignition, the values may be changed, but the blower will not operate.

**NOTICE** The Low Fire Hold switch is located near the Calibration switch.

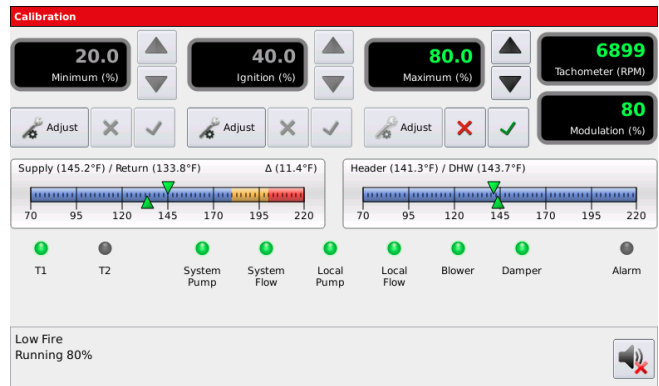
While in Standby (no call for heat on inputs), the minimum percent may be preset. To set the minimum rate while running, any (1), and only (1) of the (T) inputs must be closed in order to set the boiler to MINIMUM fire.

To adjust the MINIMUM (%) as shown in the display, press the Adjust button under the Minimum setting. The percentage value will turn green. Adjust the Minimum value to the desired setting using the arrow keys. The Minimum setting is clamped to its lowest rated setting and cannot be adjusted below this. Once you are done with this setting, press the 'X' key to throw out the setting or the check key to save.

**NOTICE** All Faults must be cleared before adjustments can be made.



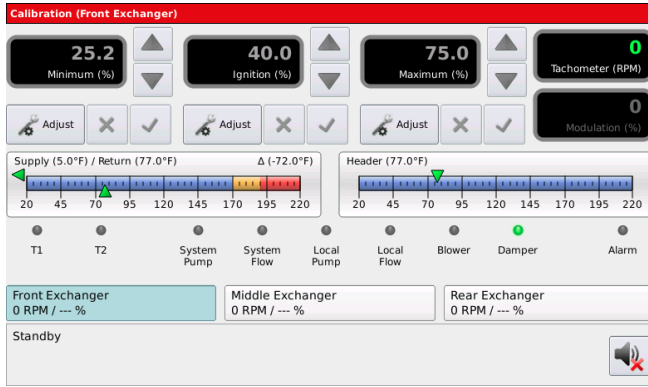
To adjust the IGNITION value as shown in the display, press the Adjust button under the IGNITION setting. The percentage value will turn green. The Blower speed will be set here to provide the rate for ignition. While in Standby (no call for heat on inputs), the Ignition percent may be preset, before firing the boiler. To set the ignition rate while running, any (1), and only (1) of the T inputs must be closed. Pressing the Adjust key here will cause the IGNITION setting to turn green and the boiler will ramp to the ignition setting. Adjust it using the arrow keys and then press the green check key to save the value. Press the 'X' key to discard the setting.



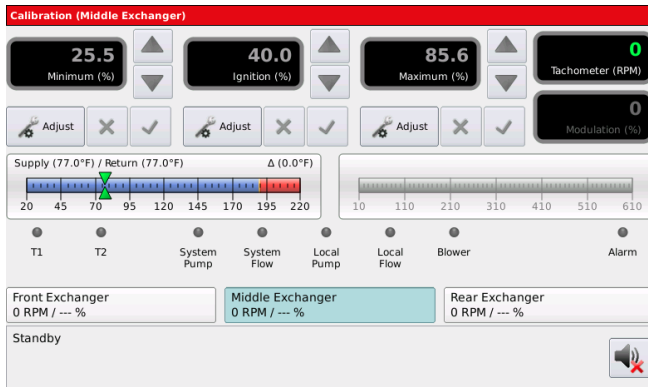
The MAXIMUM % value is used to set the maximum fire rate of the boiler. To adjust the Maximum fire rate of the boiler, press the Adjust button under the Maximum (%) value shown in the display. The percentage value will turn green. Then use the arrow keys to adjust the value up or down. Adjust it using the arrow keys and then press the green check key to save the value. Press the 'X' key to discard the setting.

### Calibration with Multiple Heat Exchangers

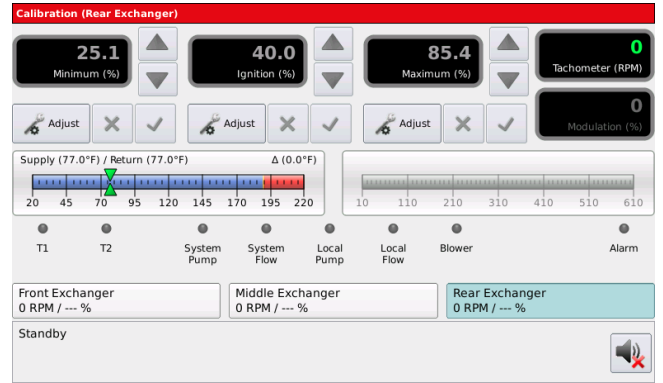
For boilers with more than (1) heat exchanger, the screen controls for these other heat exchangers can be accessed by the use of the exchanger switching button icons.



The heat exchanger box high-lighted in blue represents the heat exchanger that is being calibrated.



To select the heat exchanger to be calibrated, simply choose that heat exchanger button.



While calibrating exchanger 2, exchanger 3 can be switched to and adjusted, then switched back to exchanger 1 to balance the system.

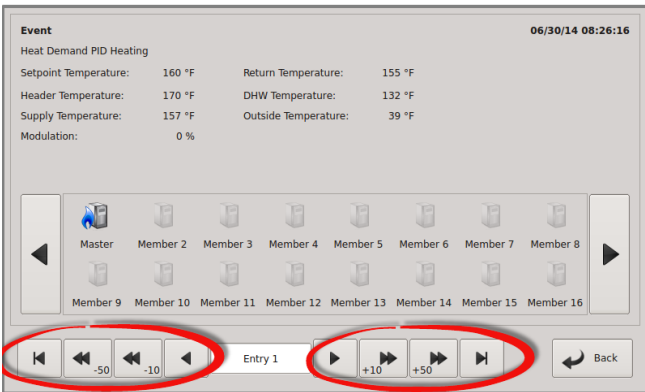
# Log Entry



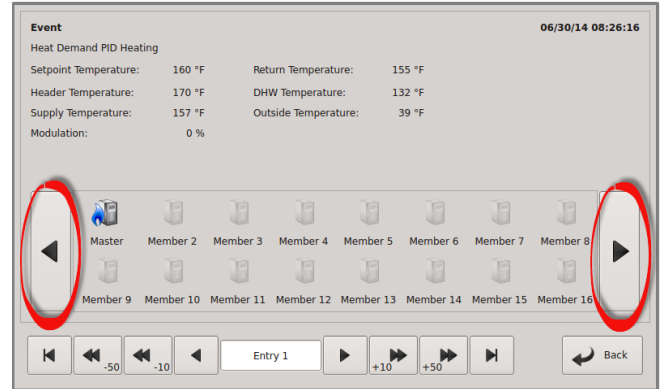
The FlexCore CK-Series H-Net control contains a log that records the major activity (events) in the operation of the boiler. This activity includes interlock faults, boiler starting and stopping events, power cycles, misc. faults, and types of calls-for-heat (control inputs). Setting the time clock to an accurate time and date is very useful when events are recorded, since the control will time stamp each snapshot. If the system is configured to run with HeatNet, then only the Master boilers SYSTEM TIME needs to be entered. The Master will then set the time on all Member boilers.

The log is primarily used as a troubleshooting and diagnostic tool, but may be used as a performance tool to view run time cycles.

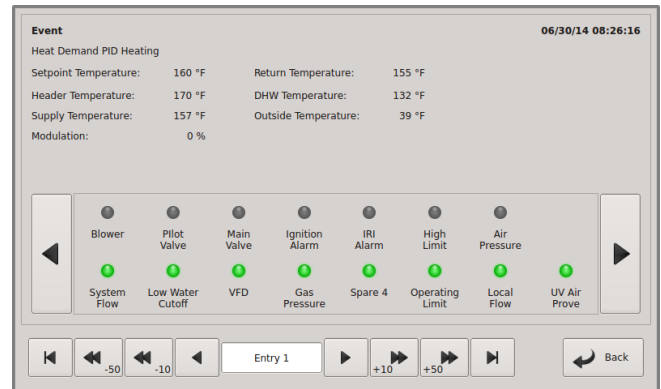
An event in time of the boiler's state is presented via multiple screens. Each screen event can be stepped through using the arrow keys.



The top line, left corner indicates any condition that caused the event. This may be a fault (such as to indicate a sensor that has failed.) or general event as denoted by "Event". The top line, right corner displays the time and date the event occurred. In the bottom center of the command bar, the event # is displayed so that easy indexing can be done using the arrow keys. The second line from the top displays the type of heat demand for that event. The next few lines display the Setpoint, Return, Header, DHW, Supply and Outside temperatures. The last line displays the Modulation.



The Center middle annunciator shows icons of the boilers in the system/standalone with graphics indicating if they are firing. The large arrow buttons on the left and right of the boiler icons allow the viewing of the control state.

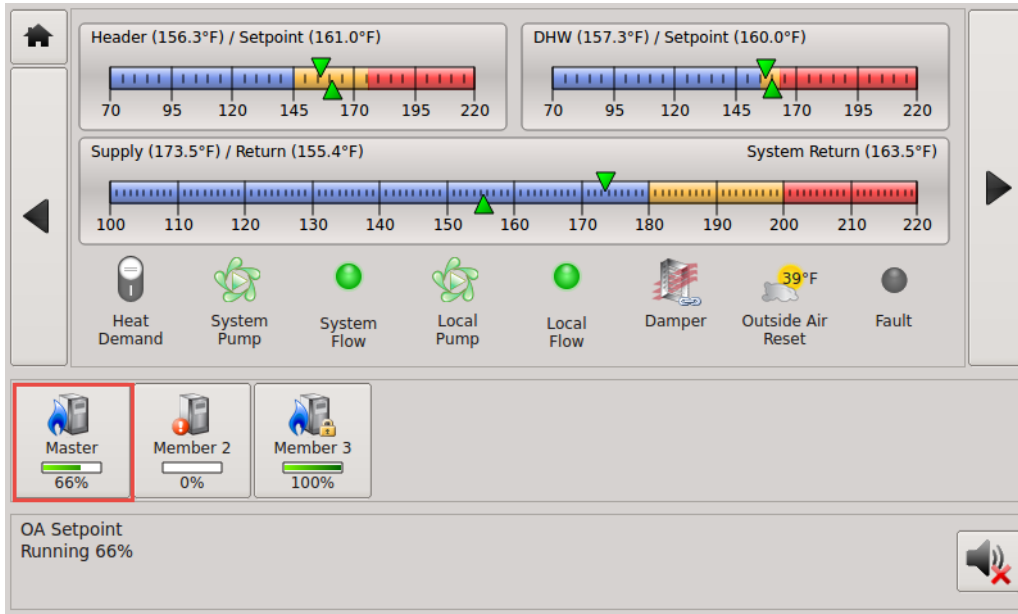


They are the Circulator Pump state, and the ignition sequence condition (Main Valve, Pilot Valve, Blower, and the Ignition alarm). There are also indicators for interlocks and auxiliary functions.

The log may also be viewed using HeatNet Pro or HeatNet Online.

# Control Settings Menu

To Enter the Settings menus the first boiler button must be selected. The button is highlighted by the red box.

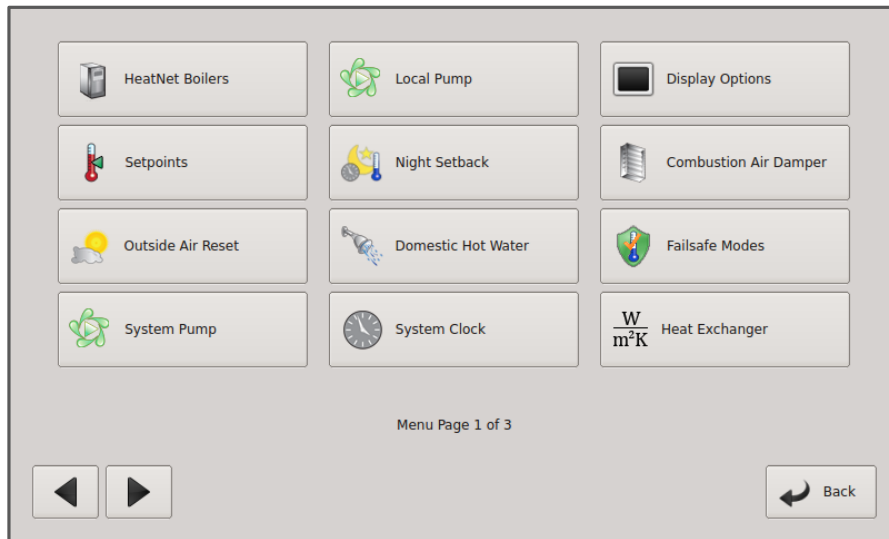


Next, press the Settings box as also illustrated by the red box.

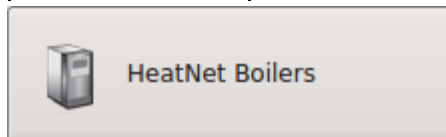


The Settings Menu Page 1 will then be displayed.

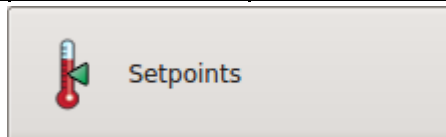
# Control Settings Menu — Page 1



MENU	DEFAULT VALUE	RANGE	DESCRIPTION
------	---------------	-------	-------------



# OF BOILERS	1	1-16	If operating as a member.
LEAD BOILER #	0	0-16	# of first boiler to run, determines the fire order in rotation. A 0 disables the Lead Boiler function. Firing Mode determines lead.
BOILER GRAPHIC	M	M-16	This Box displays the boilers auto detected by H-Net. While M is the Master boiler the numbers are the H-Net address of each boiler from 2–16.




LOCAL SETPT/ SYSTEM SETPOINT	160 °F	40-195 °F	Local setpoint used to maintain temperature of SETPT SOURCE System Setpoint is used by the Master.
HEAT BAND	20 °F	2 -50 °F	Differential temp around setpoint used to stage boiler(s) OFF/ON
OPERATE LIMIT	190 °F	45-200 °F	When running as a member, boiler shuts off when supply temperature reached. Boiler restarts at lower temp of OP LIM BAND or 10F whichever is lower
OPERATE LIMIT BAND	5 °F	1-50 °F	Limits external input % when in (OP LIM - OP LIM BAND)
SETPT SOURCE	AUTO	AUTO 4-20 mA	AUTO = Local/ System/ WWS Setpoint is used 4-20 mA input is mapped to a setpoint.



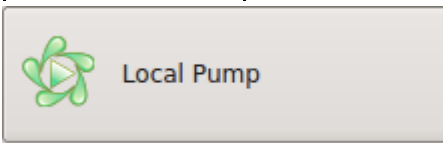

Outdoor Air Reset

WARM WEATHER SD	ON	ON/OFF	If set to YES, the boiler /system shuts down when the temperature exceeds the WWS SETPOINT.
WWS SETPOINT	68 °F	40 – 100 °F	Temperature at which boiler shuts down, operation is below this. If boiler is running using either OA RESET or WWS and the OR OVR input is closed the OA RESET slope is overridden and runs at local setpoint until OR OVR input opens.
OA RESET	OFF		Outdoor reset ratio (boiler water temp/outside air temp).
WATER TEMP AT HIGH OA TEMP	140 °F	60 – 190 °F	Boiler water temp setpoint when OA temp is at HIGH OATEMP These four setpoints determine the OA reset slope.
	70 °F	50 – 90 °F	
WATER TEMP AT LOW OA TEMP	180 °F	70 – 195 °F	Header/Supply setpoint when OA Temp is at LOW OA TEMP
	10 °F	-35 – 40 °F	

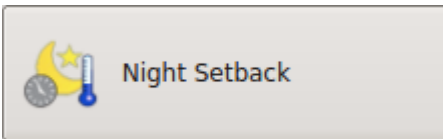

System Pump

SYSTEM PUMPS	1	1 or 2	The number of system pumps connected.
POST PRGE TIME	5 Minutes	1 – 60 Minutes	Time in minutes to keep system circ. pump on after boiler stops
ROTATION:	NONE	NONE SYSTEM HOURS PUMP HOURS	
ROTATE TIME	240 HRS	1-1000 HRS	<p>If ROTATION is set to SYS HRS, ROTATE TIME is used to switch pumps when this time expires. This time is measured against the actual time the system pump is enabled. This would include a post purge time.</p> <p>If ROTATION is set to PUMP HRS, ROTATE TIME is used to switch pumps when the pump’s time difference is greater than ROTATE TIME. Whichever pump has the least time and is at least below the other (pump’s time - ROTATE TIME) will switch to the enabled state. This selection is used to equalize run time on the pumps.</p>
SUMMER PUMP JOG	OFF	ON/OFF MON-SUN	<p>Used with Outdoor Reset, Jogs the local and system pump(s) for POST PRGE time when system is in summer shutdown. Jog once a week @12:00 AM.</p> <p>The menu item OVR ENAB IN WWS and ALWAYS ENABLED must be set to OFF for the jog function to work,</p>
ZERO RUNTIME	PUMP1	PUMP1- PUMP2	This menu allows the clearing of a pump’s runtime counter. Discretion is advised in clearing only one pump’s hours after replacement and then using ROTATION set to PUMP HRS. This would cause the pump whose runtime was cleared to run until it’s time exceeded the other older pump.
PUMP1 TIME		0-999999 Hours	Indicates how many hours the HeatNet control has accumulated on pump 1.
PUMP2 TIME		0-999999 Hours	Indicates how many hours the HeatNet control has accumulated on pump 2.
ALWAYS ENABLED	OFF	ON/OFF	ON = Pump never shuts off. Used when there is only 1 system pump in the system.

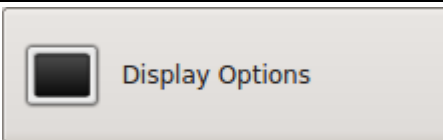
<p>OVERRIDE ENABLED IN WARM WEATHER SHUTDOWN</p>	<p>OFF</p>	<p>ON/OFF</p>	<p>Priority mode for the system pump while in Warm Weather Shutdown. ON: The system pump is allowed to run in WWS when the OR OVR override input is closed. When set to OFF, the system pump will not come on while in WWS with the OR OVR override input closed. Enabling this feature disables the SUMMER PUMP JOG.</p>
--	------------	---------------	---




<p>DELTA TEMPERATURE ENABLED</p>	<p>OFF</p>		<p>ON: Use Delta temperature to shut pump off when temperature across boiler is less than DELTA TEMP setting.</p>
<p>DELTA TEMPERATURE</p>	<p>10 °F</p>	<p>2 – 50 °F</p>	
<p>POST PURGE TIME</p>	<p>2 minutes</p>	<p>1-60 Minutes</p>	<p>Time in minutes to keep local circ. pump on after boiler stops</p>
<p>ALWAYS ENABLED</p>	<p>OFF</p>		<p>Pump never shuts off.</p>
<p>LOCAL PUMP VFD</p>	<p>OFF</p>	<p>ON/OFF</p>	<p>ON: Outputs a 0-10VDC or 4-20 mA signal from J4 pins 1 &amp; 5 that is proportional to the fire rate of the boiler. Connect to a VFD controlling a Local pump.</p>
<p>FLOW PROVE</p>	<p>10 Seconds</p>	<p>10-240 Seconds</p>	<p>This is an adjustable flow proving time to allow slower valves to open before proving flow.</p>
<p>MASTER PUMP/VALVE REMAINS ON</p>	<p>OFF</p>	<p>ON/OFF</p>	<p>ON: The Master boiler will keep its pump/valve on when no boilers are running. Prevents deadheading the system flow.</p>




<p>ENTRY</p>	<p>1</p>	<p>1 – 4</p>	<p>Four setbacks (TABBED) to adjust setpoint during a time period</p>
<p>ENABLE</p>	<p>OFF</p>		<p>Enable or disable the use of this setback</p>
<p>SETBACK</p>	<p>20 °F</p>	<p>0 – 50 °F</p>	<p>Temporarily subtracts this temp from the setpoint</p>
<p>START DAY</p>	<p>MON</p>		<p>Day of the week to begin setback or a day range</p>
<p>START TIME</p>	<p>12:00AM</p>		<p>Time to begin setback</p>
<p>END DAY</p>	<p>MON</p>		<p>Day of the week to end the setback or a day range</p>
<p>END TIME</p>	<p>12:00AM</p>		<p>Time of the day to end the setback</p>



<p>ENGLISH</p>	<p>° F</p>		<p>Fahrenheit scale, English is default</p>
	<p>GPM</p>		
<p>METRIC</p>	<p>° C</p>		
	<p>LPM</p>		

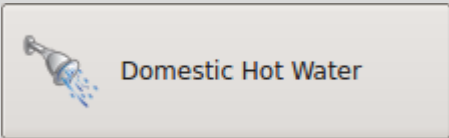

Combustion Air Damper

<b>COMBUST AIR DAMPER</b>			
<b>TYPE</b>	LINKED/ COMMON	LINKED/ COMMON INDEPENDENT	The LINKED/Common setting allows one common damper to be used and controlled by the Master Boiler. All Member boilers must have their damper prove inputs wired as per Figure 58, Common system damper wiring, page 84. Also see Section: <i>Optional Features: Auxiliary Function Options</i> INDEPENDENT: Individual dampers are in controlled by their respective boiler.
<b>IN USE?</b>	YES	YES/NO	If set to YES, then OUTPUT RELAY K5 can be used to control a combustion air damper. The Master can control a common system damper or an individual damper. Members control their respective damper independent of the Master. Relay K5 is used to enable the combustion air damper. See Figure 58, Common system damper wiring, page 84. Needs to Prove the damper is open.
<b>INPUT:</b>	J12B.7 DAMPER		The damper prove input is dedicated to connect at J12B terminals 7 and 8. If using a common damper refer to the common damper wiring diagram.
<b>PROOF TIME</b>	2:00	0 – 4 Minutes	This is the proving time in minutes for the combustion air damper prove switch. It is sensed at J12B Pin 7. If the damper faults, a retry will occur every 10 minutes in attempt to open the damper. When using J12B in a common damper configuration, wiring is done beginning with the Master boiler. J12B Pins 7 & 8 are connected to the prove switch of the combustion damper. Pin 8 is supplying 24 VAC and pin 7 is the sense input. A second wire is connected to J12B pin 7 of the Master and the other end connected to the first member boilers J12B pin 7. If another member boiler is present, connect another wire to the J12B Pin 7 terminal of the first member and the other end to the second member boiler J12B pin 7. Continue this method for each additional boiler.


Failsafe Modes

<b>RUN IN LOCAL IF: H-NET COMMUNICATIONS LOST</b>	OFF	ON/OFF	If this entry is set to ON and the Member boiler does not see any communications coming from the Master boiler, this boiler will run in LOCAL. The boiler will continue to run in LOCAL until communications are re-established or this entry is set to OFF.
<b>LOW TEMPERATURE SENSOR</b>	NONE	SUPPLY, HEADER, RETURN, NONE	This entry may be set to one of the temperature sensors: SUPPLY, HEADER, RETURN, or turned OFF (default). If this entry is set to a sensor and the temperature falls below TEMP, the boiler will automatically start and run the water temperature up to the LOCAL Setpoint and then shut OFF.
<b>TEMP &lt; 40F</b>	40 °F	35-200 °F	This is the temperature that the selected sensor must fall below for the boiler to start.

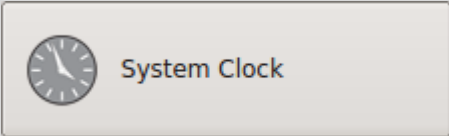
<div style="border: 1px solid black; padding: 5px; display: inline-block;"> <math>\frac{W}{m^2K}</math> Heat Exchanger                 </div>			
ALARM TYPE	WARNING	FAULT, WARNING	<p><b>FAULT</b> will stop the boiler when the Delta T has exceeded its setting.</p> <p><b>WARNING</b> will allow the boiler to continue running, but produce the Warning message.</p>
EXCHANGER DELTA T	*AUTO 60 °F	*AUTO 1 to 100 °F	<p>*Settings are AUTO if running DELTA HIGH/LOW protection.</p> <p>This is the maximum differential temperature the heat exchanger can see before the LIMIT RATE feature is activated, and a log entry is made.</p>
LIM TO HALF RATE	*NA YES	YES/NO	<p>*Not Available when operating in DELTA HIGH/LOW protection.</p> <p>Limit to Half Rate: When set to YES, and the maximum differential temperature (delta T) has been exceeded, the fire rate called for is cut in half. In other words: if we are calling for 80% modulation and have exceeded the delta T, the boiler will only fire at 40%. The delta T needs to drop 10F below the maximum delta T to reset this limit. The message “½ INPUT” will be displayed on a member boiler and a Master Boiler will display the Modulation % for the system even though it is running at ½ of this rate. This method helps protect the heat exchanger from damage due to excessive delta T’s. If this Master boiler is running</p>
SEND RETURN	RETURN	RETURN, SYSTEM RETURN	<p>This setting is used by the Master boiler to select which Return sensor temperature to send to all Member boilers. The Return temperature will then be used by the Member boilers (usually non-condensing) to determine if they can be called by the Master to run.</p> <p>If a System Return sensor is available on the Master, set this setting to SYS RET. If only a Return sensor is available, set to RETURN.</p>
TEMPERATURE DISAB	OFF	SYSTEM RETURN, RETURN, OFF	<p>This setting is used by a Member boiler (primarily a non-condensing type) to determine which return sensor to look at when determining if it is safe to fire. Its purpose is to keep non-condensing boilers from firing in a condensing mode.</p> <p><b>SYS RET</b> the boiler will use the Return temperature sent from the MASTER boiler.</p> <p><b>RETURN</b> the boiler will use its own Return sensor. If it is set to OFF, then this feature will not be used.</p> <p>If a sensor is selected, then the Boiler will determine if the Return sensor’s temperature is below the TEMP&lt; XXX setting in the following menu. If the Return temperature is lower, the boiler will take itself offline from the Master. Informing the Master that it can’t run. The message “<b>blr offline</b>” will be displayed in the Status screen.</p>
TEMP<140F	140	135 – 200 °F	<p>Setting determines where the TEMP DISAB return sensor’s threshold temperature disables the boiler from firing.</p>
EXTENDED POST PURGE TIME:	0 Seconds	0-600 Seconds	<p>This time may be used to remove condensation that is still present on the heat exchanger after the boiler has finished running. The time may be adjusted to 600 seconds (10 minutes). Unlike the 10 second fixed post purge time the extended post purge time may be interrupted by a call for heat.</p> <p>If the extended post purge is active, an “*” will be displayed next to “STANBY*”. This indicates that the boiler is still ready to run, but is completing an extended post purge. As always, the STATUS screen will display the meaning of the “*”. In this case: EXTEND PP.</p>



PAGE 1			
BOILER MODE	AUTO	AUTO, LOCAL, COMBINATION	<p>Setting this value to LOCAL or COMBINATION enables the DHW PID. Setting this value to AUTO disables the DHW PID.</p> <p><b>LOCAL</b> allows the boiler to run in DHW locally off of its own sensor or thermostat input. The boiler could be configured to run as a space heating boiler that is controlled by a Master. It would also monitor a tank or DHW call and disconnect from the Master to provide local DHW heat.</p> <p><b>COMBINATION</b> allows the boiler to be configured to run as a space heating boiler and a DHW boiler that is controlled by a Master. This would use both the space heating PID and the DHW PID to simultaneously control space heating and DHW heating.</p> <p>NO, turns off the DHW PID, but still allows control of the DHW pump and DHW setpoint for backwards compatibility.</p> <p>*Note: If the System is configured to use the OR OVR input to override the heating setpoint with the DHW setpoint, the DHW PID is not used. Since this method does not use the DHW PID, the DHW BOILER setting should be set to NO. The DHW SETPOINT, POST PURGE, LOCAL PUMP OFF, LOCAL DELAY, and PURGE TO THE: may need to be set if this method is used. This method does allow configuring the LOCAL and DHW pumps.</p>
SETPOINT	160 °F	40 – 200 °F	Setpoint that the boiler/system will target when a call for DHW.
LOWER BAND	5 °F	1 – 30 °F	DHW SETPOINT – LOWER DHW DIFF: if the DHW water temperature is less than this temperature, the Boiler/System will enter DHW Heating mode if DHW BOILER? is set to LOCAL or MIXED or COMBINATION.
UPPER BAND	3 °F	1 – 30 °F	DHW SETPOINT + UPPER DHW DIFF: if the DHW water temperature is greater than this temperature, the Boiler/System will begin shutting off DHW boilers if the DHW BOILER? is set to LOCAL or COMBINATION.
PUMP PRIORITY	NO		If the DHW PRIORITY is set to YES, then when there is a call for DHW, the system pump shuts off. If NO, the system pump stays on.
POST PURGE	120 Seconds	5-600 Seconds	This is the time that the DHW relay remains on after the DHW call ends.
USE SENSOR	NO		If this entry is set to YES, the DHW 10k Sensor is looked to for controlling DHW water temperature. If set to NO, A thermostat is used.
SHARING	CYCLE	OFF, NO CYCLE, CYCLE	<b>NO CYCLE</b> allows the boiler to perform as a space or DHW heating boiler. DHW always has priority and will override (steal) a space heating boiler that is running when none are available to perform DHW heating. When this happens, the boiler will not shut down, but keep running during the change from space heating to DHW (Hot Swap). Once the DHW cycle completes, the boiler will shut down and wait to be called for space heating again.

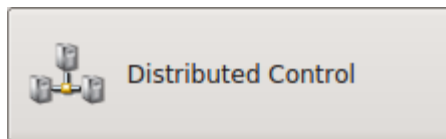
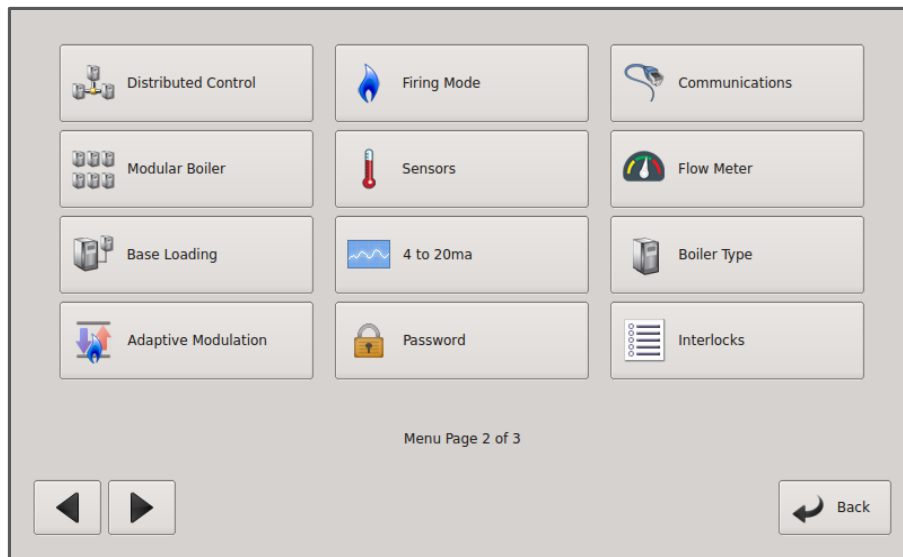
			<p><b>CYCLE</b> allows the boiler to perform as a space or DHW heating boiler. DHW always has priority and will override (steal) a space heating boiler that is running when none are available to perform DHW heating. When this happens, the boiler will shut down and exit the space heating mode. The boiler will then re-start as a DHW heating boiler. Once the DHW cycle completes, the boiler will shut down and wait to be called for space heating again.</p>
PAGE 2			
LOCAL PUMP OFF	YES	NO/YES	<p><b>YES</b> will shut off the local pump/valve when DHW heating is in effect. If the boiler is running in space heating mode, the LOCAL DELAY will be in effect before the local pump/valve shuts off.</p> <p><b>NO</b> both the local and the DHW pump/valve will be enabled during DHW heating.</p>
LOCAL DELAY	5 Seconds	0-600 Seconds	<p><b>Seconds</b> is the time in seconds that the local pump/valve will remain on after the DHW pump/valve is enabled before shutting off. This is part of the changeover process when the boiler was running in space heating mode and now needs to provide DHW heating.</p> <p>This timer may also be used for race conditions when operating valves. The Local Pump Flow Prove time would be used to prove flow, but with valves, the local valve may still have flow when the DHW valve begins to open. This would cause a flow fault when the local valve closes and the DHW valve still has not opened.</p> <p>The way it works, is that these timers work in parallel, but this timer only counts down when flow is present. It stops counting down when flow stops, but will not cause a flow fault until its time expires. The Local Pump Flow Prove timer counts down, but normally when flow occurs, it proves and the boiler is allowed to run. This local delay timer would then take over instead of allowing the boiler to run, and wait until its time expires before allowing the boiler to start. This timer proves that there is flow, whether interrupted or not, for x (setting) seconds. If pumps are used, this value can be set to a few seconds.</p>
PURGE TO	TANK	TANK, SPACE	<p><b>TANK</b> will keep the DHW pump/valve enabled for the DHW POST PURGE time thus purging some of the boilers heat into the tank.</p> <p><b>SPACE</b> will turn off the DHW pump after 5 seconds and enable the local pump/valve when a DHW heating cycle completes. This allows dumping some of the remaining heat from the boiler into the heating space (dump zone) and preventing the tank from overheating.</p>
HYBRID SENSOR	OFF	OFF, SUPPLY, DHW, RETURN	<p><b>Hybrid mode sensor for DHW method 5A</b></p> <p><b>OFF</b> This sensor is selectable for DHW Method 5A only.</p> <p><b>SUPPLY</b> In DHW Method 5A will maintain the DHW setpoint at the supply sensor when the OR OVR input is closed.</p> <p><b>DHW</b> In DHW Method 5A will maintain the DHW setpoint at the DHW sensor when the OR OVR input is closed. This sensor is optional and needs to be added. It can be moved around and placed in the Tank, pipe feeding the tank, or other location to maintain a setpoint at that location.</p> <p><b>RETURN</b> In DHW Method 5A will maintain the DHW setpoint at the RETURN sensor when the OR OVR input is closed.</p>

MAXIMUM RUNTIME	120 Minutes	0 - 200 Minutes	This is the maximum runtime of the boiler when DHW heating. When this runtime is exceeded, the boiler will either Lockout or re-cycle to the Holdoff Time setting below.
HOLDOFF TIME	30 Minutes	LOCKOUT to 120 Minutes	If set to Lockout, the boiler will no longer perform DHW Heating. A manual reset or toggling the OR OVR input will reset the Lockout.  If a time is set, the boiler will wait this time before it can perform DHW heating again.
PUMP ALWAYS ON	NO	ON/OFF	If set to On the domestic hot water pump will run continuously.



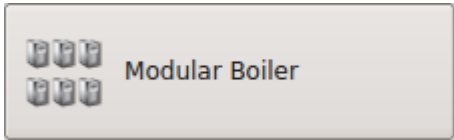
TIME			This time needs to be entered at first turn-on and in the event that power has been lost for more than 3 days. The time is required for an accurate Night setback, log entry time-stamp, and fault time stamp.
MONTH			
DAY			
YEAR			
WEEKDAY			

# Control Settings Menu — Page 2




CONTROL	H-Net		Displays method of operation: HeatNet (H-Net)
H-Net MASTER	YES		Auto detected, based on the HEADER sensor. If the HEADER sensor is present and is set to TYPEZ, the FlexCore CK-Series control is run as a H-Net MASTER (YES). If the HEADER sensor is not TYPEZ, H-Net MASTER = NO.
MASTER TYPE	AUTO	AUTO, MIXED (COMBINATION), DHW ONLY	Two PID controls are provided, one for Space heating and one for DHW heating. This menu item selects how they are to be used. The MASTER TYPE setting is used to determine if the MASTER control is to be used as a space heating control, a combination DHW/space heating control, or just to perform DHW Heating.  When set to AUTO, the boiler uses one PID control to provide space heating. When set to Combination, the control will use two independent PID controls to provide space heating and DHW heating. When set to DHW, the control only uses the DHW PID control.
HEATNET ADDRESS	255	2 –16	The local address is the address of a member device. This is normally in the range of 2 through 16. But if the FlexCore CK - Series control is a MASTER, then the default address is 255. The H-NET ADDRESS # is synonymous with boiler #.






SPACE HEATING DHW HEATING	TABS		If the MASTER TYPE is set to COMBINATION, or the DHW BOILER? setting is set to LOCAL or COMBINATION, the MODULAR BOILER SET is duplicated for each PID. Select SPACE HEATING to set the ADD, SHED, MODULATE, and MOD MAX values for the space heating PID. Then select DHW HEATING to set the ADD, SHED, MODULATE, and MOD MAX values for the DHW heating PID.
ADD BOILER DELAY	10 Minutes	0 – 60 Minutes	This is the delay time in 30sec intervals, before starting a new boiler. Boiler #1 is started immediately after a call for heat. If a second boiler needs to start, the ADD BOILER DELAY will need to expire before starting.
SHED BOILER DELAY	2 Minutes	0 – 15 Minutes	This is the delay time in 30 second intervals, before stopping a boiler. A boiler is stopped immediately when the top of the heat band is exceeded. If a second boiler needs to stop, the SHEDBOILER DELAY will need to expire before stopping.
MODULATE DELAY TIME	10 Seconds	0 – 60 Minutes	This is the time the boiler remains in min-fire before it relinquishes control to the modulation % signal.
MODULATION MAXIMUM – (LAST FIRE)	70%	(25 – 100%)	<p>This value represents the maximum % of input on the boilers if all the available boilers are not firing. Once all boilers are firing, this clamp is removed and all boilers are allowed to modulate up to 100%. When this value is limiting the input an ‘*’ is displayed and the “INPUT CLAMP” message is displayed in the STATUS screen. This value is derived by: multiplying twice the minimum fire rate of the boiler with the least turndown (2* turndown (20% 5:1, 25% 4:1, 33% 3:1)).</p> <p>In mixed boiler size configurations, more than (2) boilers in a system, or when “bumps” in the temperature occur as boilers are added and subtracted, this value may need adjustment. The adjustments will help produce smooth temperature control when each boiler is started and stopped. This method ensures that, once a new boiler starts to fire, and holds its fire rate at the minimum setting, it does not add its BTU output to a boiler already firing at 100%. The boilers cannot be fired starting @ 0%, but start at a minimum (example: 20%) and introduce a minimum amount of BTUs into the system. Section: SETUP &amp; OPERATION</p> <p>The MOD MAX value is also applied when using the AA terminal for High Fire and when using the 4-20 mA input for direct modulation. When these demands for heat are used, the maximum modulation the boiler can obtain when first starting is equal to the; ADVANCED SETUP: MODULAR BOILER SET: MOD MAX – LAST FIRE:. The timer value ADVANCED SETUP: MODULAR BOILER SET: ADD BOILER DELAY is used in conjunction to limit the modulation for this amount of time. Once the boiler has fired and the ADD BOILER DELAY time expires, the full modulation is available. This change is a protective means for extending the life of the heat exchanger which may consistently be exposed to thermal stress.</p>
RELEASE MODULATION MAXIMUM (DHW ONLY)	YES	YES/NO	In the DHW Heating tab, if set to Yes, the modulation % will not exceed the MODULATION MAXIMUM set in the MODULATION MAXIMUM – (LAST FIRE) setting.

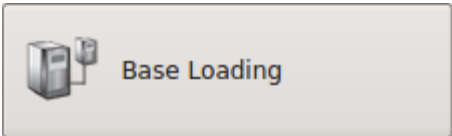

Adaptive Modulation

ADAPTIVE MODULATION	ADAPTIVE		<p>If MODULATION MODE is set to ADAPTIVE on the Master boiler, the Master lowers the system modulation rate of all currently running boilers before a newly started boiler enters the Main Valve state. Upon entering the Main Valve state of a newly fired boiler, the Master waits the DELAY RELEASE time before allowing the PID to resume modulation control. With MOD MODE set to ORIG KN, The Master boiler keeps firing at the current modulation rate when a new boiler is added and lets the PID adjust modulation rate accordingly.</p>
DROP DOWN MODE	ON CALL		<p>If drop down is set to ON PILOT and MOD MODE = ADAPTIVE, and when a newly added boiler starts, the system waits until it enters its PILOT state before bring the system modulation down. This allows for the system to prepare for the new energy that is to be introduced. If DROP DOWN is set to immediately, the system modulation is lowered as soon as the newly added boiler is called.</p>
DELAY RELEASE TIME	5 Seconds	0 – 600 SECONDS	<p>Once the Main Valve opens on the newly added boiler and the MOD MODE = ADAPTIVE the Master waits this amount of time before releasing the PID to control modulation. This allows for the newly added boiler to accumulate some soak time.</p> <p>This is a global delay controlled by the Master boiler. It is comparable to the MODULATE DELAY setting, but this is a local setting on each boiler.</p>

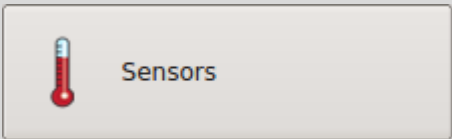

Firing Mode

FIRING MODE	RUNTIME		<p>LOFO: Boilers are fired Last On, First Off starting with Lead Boiler                  FOFO: Boilers are fired First On, First Off  <b>RUNTIME:</b> Boilers are fired based on the runtime they report back to the Master boiler. Boilers with the least runtime are fired first and boilers with the most runtime are stopped first.                  MIXED: Different types of boilers can be mixed in a system and fired based on (2) Priority sets. Boilers are started and stopped within their Priority sets based on their runtime hours.</p>
MINIMUM RUNTIME	10	1 – 750 HOURS	<p>When the firing rotation is based on runtime, this value represents the interval in hours of runtime before rotation occurs. Boiler to Boiler.</p>
MINIMUM OFF TIME	0	0 - 10 MINUTES	<p>This is the time in minutes that the boiler must remain OFF before it can be fired again. Very effective in dynamic systems to minimize short cycling of a boiler and force the call to the next boiler (with next shortest runtime if True Runtime is used)</p>
FIRING PRIORITY:	2	1 or 2	<p>There are (2) Priority settings used by the MIXED boiler rotation algorithm. Priority 2 is the default and lowest priority. Priority 1 Is the highest priority. A Priority may be assigned to a set of boilers which fires and rotates based on time and is independent of the other Priority set.</p>
PREDICTIVE START:	YES	YES/NO	<p>YES: Predicts the boiler restart point in the heating band while the temperature of the boiler is drifting down through the band. The purpose of this is to ensure the temperature remains in the heating band. It also minimizes temperature swings when the boiler is stopped and started at low inputs.</p>

			This algorithm looks at the size of the band and at what rate the temperature is falling. It then calculates when to start the boiler (knowing its starting time) to ensure the boiler starts within the band. Once the boiler starts, the Add Boiler Delay time starts and continues to expire in and below the band. This ensures that another boiler does not start when it leaves the bottom of the band.
MIXED BOILERS TAB			
START PRIORITY SET WHEN	ALWAYS FIRST	ALWAYS FIRST, OUTSIDE AIR IS ABOVE, RETURN IS BELOW	
STOP PRIORITY SET WHEN	ALWAYS LAST	ALWAYS LAST, OUTSIDE AIR IS BELOW, RETURN IS ABOVE	

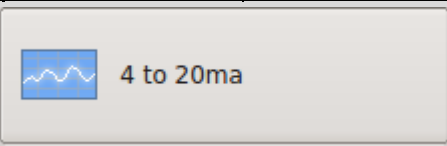


BOILERS:	0	0 - 1	This setting works in conjunction with the ADVANCED SETUP: SYSTEM: OPTION setting BASE LOAD. Currently only (1) base load boiler is supported using relay K8
START WHEN	MODULATION IS ABOVE	MODULATION IS ABOVE, OUTSIDE AIR IS BELOW, RETURN IS ABOVE	Used in Conjunction with DELAY TIME.
MODULATION IS ABOVE	95%	0 – 100 %	The base load relay K8 will close when the Modulation is >%.
OUTSIDE AIR IS BELOW	15 °F	-40 – 130 °F	The base load relay K8 will close when the OA temp is > T
RETURN IS ABOVE		60 – 150 °F	The base load relay K8 will close when the Return temp is > T.
STOP	ALWAYS FIRST	ALWAYS FIRST, MODULATION IS BELOW, OUTSIDE AIR IS ABOVE, RETURN IS BELOW	
MODULATION IS BELOW	40%	0 – 100 %	The base load relay K8 will open when the Modulation is <%.
OUTSIDE AIR IS ABOVE	25 °F	40 – 130 °F	The base load relay K8 will open when the OA temp is > T.
RETURN IS BELOW	150 °F	25 – 210 °F	The base load relay K8 will open when the Return temp is < T.
DELAY TIME	0	0 – 60 Minutes	This setting allows a wait time before firing the base load boiler once the start condition is met.

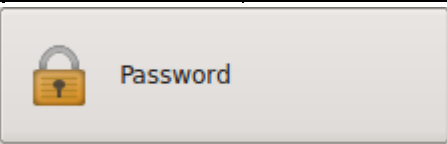


**NOTICE** Sensors can only be changed when there is no call for heat. The boiler must be in STANDBY.


SENSOR		OUTSIDE, SUPPLY, RETURN, HEADER, DHW, STACK, SYSTEM RETURN	The first (4) sensor #'s are reserved as: OUTSIDE AIR, water SUPPLY outlet, water RETURN inlet, and system HEADER temperature. If the HEADER sensor is used (TYPEZ), that boiler performs the tasks of the MASTER boiler. If the HEADER sensor is set to NONE, its function is the MEMBER. The next (3) sensors perform DHW, Stack, and System Return measurements.
			There are (4) sensor types: NONE = does not use this sensor TYPEZ = 10k thermistor PT = 1k Platinum (only for Stack temperature) ON/OFF = 5 volts supplied out to detect a contact/switch closure.



CHANNEL:	1	1	There are (2) channels that may be configured for 4-20 mA inputs or 0-10VDC inputs. They are labeled 4-20 mA (1) and 4-20 mA (2). The 4-20 mA (1) input is used to direct fire a boiler or to remotely control the setpoint of the boiler. Analog channel (1) is the primary channel used for direct modulation and remote setpoint control.  The 4-20 mA (2) is a dedicated input used for metered input such as: Flow meters, etc.
MODE:	4-20 mA	4-20 mA or 0-10VDC	Type of input to use for the ANALOG IN CHANNEL selected above. The input may be changed from 4-20 mA to 0-10 VDC. The dip switch S6 also needs to be set correctly in conjunction with this setting.
START SETPOINT	50 °F	50 - 195 °F	When using 4-20 mA setpoint control in SETPOINTS: SETPOINT SOURCE. This is the temperature when a BOILER START signal (see BOILER START menu below). The Setpoint will then be mapped from 4 mA –20 mA and example default of: 50-220F
20 mA SETPOINT or 10 V SETPT	220 °F	50 - 195 °F	This is the setpoint temperature when a 20 mA or a 10 VDC signal is applied.
BOILER START	4.11 mA Or 2.04V	3.71 - 5.0 mA Or .01 - 2.50 VDC	This is the current value which will start the boiler. There is a .1 mA or .25 VDC hysteresis value. So if the Boiler starts at 4.11mA it shuts off a 4.01 mA.
PRIORITY	NORMAL		If the Priority is set to NORMAL, the boiler responds to its HEAT DEMAND inputs in the Priority that is outlined in the Control Methods section. If the PRIORITY is set to HIGHEST, The 4-20 mA input responds at the highest Priority level (same as the AA input). This method may be used by an external control to override the HeatNet control and fire the boiler using this external control (external control override). This allows for complex DHW control systems where an external control can take over the firing rate for a DHW call, and direct modulate a boiler.





ENABLE PASSWORD	NO		Provides a limited access for security, though restoring system defaults will reset the password to the value “AAAAAA”
-----------------	----	--	--


Communications

MODBUS ADDRESS	1	1 – 247	The MODBUS address is for communicating with Laptop, PC, or other MODBUS capable device, such as a Building Management System. It is the 2nd communication port reserved for host control.
BAUD RATE	19200	1200, 2400, 4800, 9600, 19200, 38400	This is the Baud rate for serial communication from the MODBUS port. Selectable from 1200, 2400, 4800, 9600, 19200, 38400.
DATA FORMAT	8E1	8E1, 8N1, 8N2, 8O1	8 bits -Even Parity -1 stop bit, valid settings: 8E1, 8N1, 8N2, 8O1
SETPOINT TIMER	ON	ON, OFF	If set to ‘ON’, the setpoint timer is enabled and requires a periodic update of its value to keep from timing out and returning control to the H-Net control. If set to “OFF”, MODBUS always has control and on a loss of MODBUS communications, H-Net does not assume control.
SETPT TIME	1 Minute	1 - 240 Minutes	This time is used to automatically reset the SETPOINT TIMER when any Modbus value is written. If it is set to 1 minute, a periodic write to one of the registers must occur within 1 minute otherwise the BMS Setpoint will revert back to the System/Local setpoint.

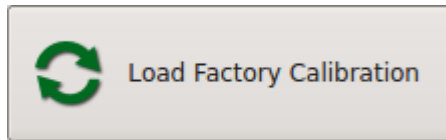
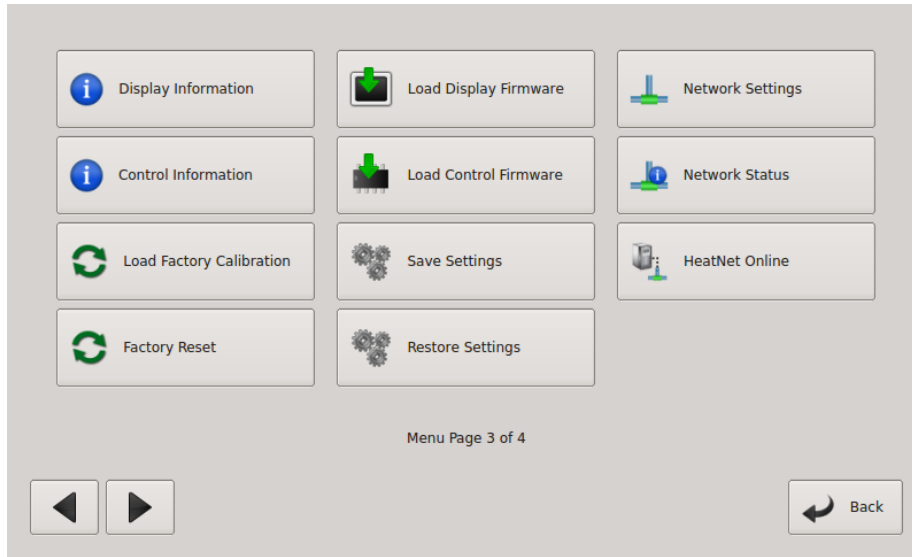

Flow Meter

ENABLED	YES	YES, NO	If a flow meter or flow control is to be used, set to YES
GLYCOL MIX	0%	0 – 100 %	Any mix over 10% de-rates the flow by 30% (rule of thumb method). Example: if the LOWEST FLOW = 50 GPM, HeatNet will calculate a New Lowest Flow required to be 65 GPM. The LOWEST FLOW does not need to be changed, but is calculated to 65 GPM and that value is used by HeatNet.
INPUT TYPE	BMS	CH2 (V), CH2 (mA), BMS,	<p>This setting determines where the flow values are originating. If set to Volts (2), then a Flow meter is providing a 0-10V signal on J10B 4-20 mA (2). Ensure that S6 switch 2 is UP for 0-10VDC.</p> <p>If the setting is mA (2), then a Flow meter is providing a 4-20mA signal on J10B 4-20 mA (2). Ensure that S6 switch 2 is DOWN for 4-20 mA.</p> <p>If the INPUT TYPE is set to BMS, a Flow Limited or a Boilers Limited method can be used. With Flow limited a GPM value can be written to the BMS GPM Modbus register 40019 with a valid flow. If the Boilers Limited method is to be used, the number of boilers that the BMS would allow HeatNet to control is written into Modbus register 40020.</p> <p style="text-align: center;">See the Flow Options section for more details.</p>

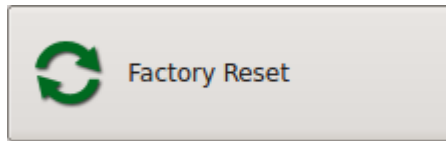
LOWEST FLOW	BY BOILER TYPE	0-500 GPM	This is the automatic value loaded and will equal the lowest flow required for this boiler (it is adjustable). It should be equal to the lowest flow of the largest boiler in the system.
HIGHEST FLOW	BY BOILER TYPE		Currently not used.
FULL SCALE	PER FLOW METER	0-1600 GPM	Enter the value of the full scale reading on the calibration card that came with the flow meter.
FLOW FACTOR	BY BOILER TYPE	PPG	Currently not used.
 Interlocks			
CONFIGURE INTERLKS			The 24 VAC interlocks can be enabled or disabled for reporting.
 Boiler Type			
PRODUCT:	MB/MW 500	MB/MW 500 - CK 9000	The product type allows configuration of the control for a product (and given a personality). This allows the control to be used/interchanged with many products. The following fields will be adjusted for the personality of the product.
CONDENSING	YES		This defines a boiler as condensing or non-condensing.
BTU INPUT	PER BOILER TYPE		This is the BTU input rating of the boiler. This value is not used with this released version and is displayed only for reference. Future releases may incorporate this feature. Check the revision history sheet on the website.
BLOWER	VFD	VFD, AMETEK, EBM	This is the blower type associated with the product. This should not be changed manually. Due to FIII/Fusions using Variable Frequency Drives, this setting needs to be adjusted for Whirlwind (Ametek) models. The default is for a VFD except for the FlexCore CK Series.
MASS	MEDIUM	LOW, MEDIUM, HIGH	This defines the mass of the boiler. This value is not used with this version and is displayed only for reference and future applications. Check the revision history sheet on the website.
TURNDOWN	5:1	3:1, 4:1, 5:1	This is the turndown of the boiler. For the FlexCore CK -Series the default is 5:1 and determines the minimum firing percentage. 5:1 = Min 20%, 4:1 = Min 25%, 3:1 = Min 33%. NOTE: The boiler must be set up for operation at this Turndown rate using the Calibrate settings. This TURNDOWN setting only controls the displayed percentage.
ALTITUDE	LESS THAN 2000FT	LESS THAN 2000 FT, GREATER THAN 2000 FT, GREATER THAN 4000 FT	This is the Altitude in feet of where the boiler is installed. On Ametek Blowers it limits the blower output for low altitudes and allows a higher output at higher altitudes. This setting sets the upper range limit of the MAX VFD setting.

OPTION:	NONE	NONE DUAL FUEL BASE LOAD	<p>When set to DUAL FUEL, input T3/ RESERVED, OPTION input is used to control the DUAL FUEL OPTION relay via K8 contacts on J4.2 &amp;.6. When set to NO OPTION the input T3/RESERVED, OPTION relay K8 on J4.2 &amp;.6 is inactive.</p> <p>When set to BASE LOAD, the Option Relay K8 on J4.2 &amp;.6 is used as an enable contact for a base load boiler. The J4.1 &amp;.5 0-10vdc/4-20 mA output is used to modulate the base load relay if it is of the modulating type.</p> <p>The limitation of the OPTION menu is that Dual Fuel cannot be used with a Base Load boiler.</p>
<b>BLOWER SETTINGS (AMETEK BLOWER)</b>	BUTTON		
ACCELERATE	3.0 %/s	0.1 – 10.0 %/s	<p>If a signal is sent to increase the blower rpm, the blower’s acceleration speed will change at this rate until its rpm is equal to the signal sent. % per second. Setting this value too high may cause overshooting of the blower rpm and temporarily over firing of the boiler. Setting this too low will slow down the response of the boiler to get to setpoint.</p>
DECELERATE	3.0 %/s	.1 – 8.0 %/s	<p>If a signal is sent to decrease the blower rpm, the blower’s deceleration speed will change at this rate until its rpm is equal to the signal sent. % per second. Setting this value too low will slow down the response of the boiler to get to setpoint. Setting this value too high may cause undershooting of the blower rpm and temporarily dropping below low fire of the boiler (Due to this condition, the deceleration rate is automatically decreased as the rpm approaches low fire).</p>
SOFT START:	2 Seconds	2 – 4 Seconds	<p>In order to start the Ametek blower, the control signal must be applied to start the blower at a low rpm. If the low speed start time is too low the Ametek blower may not start and lock out with its current limit. This may result in the need for the boiler to be recycled. If this is to be avoided, the Stage 4 relay may need to be wired to the Ametek Blower’s contactor. Doing this will allow (3) attempts to restart the blower every 10 minutes. If the time is too high, pre-purge time of the blower is lost.</p>
OFF BOILER – BLOWER	0	0 - 50 %	<p>Setting this value to any value other than 0, will run the Blower at this percentage when the boiler is OFF. This is primarily used to maintain a positive pressure in the vent pipe in extreme situations.</p>

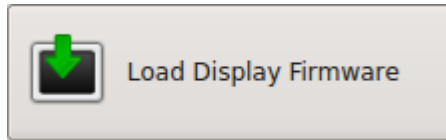
# Control Settings Menu — Page 3



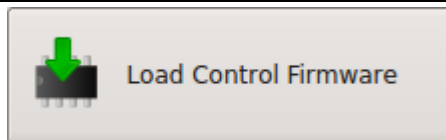
CONFIRM BOX			If the OK button is pressed, the factory set MIN, PILOT, and MAXIMUM blower rates will be loaded
-------------	--	--	--



CONFIRM BOX			If the OK button is pressed the factory default setting for all menus are loaded. This does not include the factory calibration values.
-------------	--	--	---

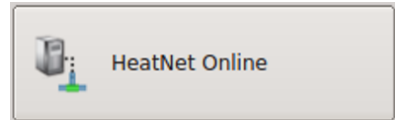
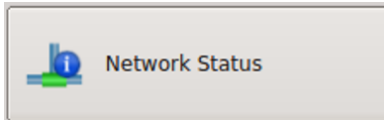
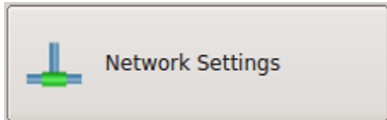


LOAD DISPLAY FIRMWARE BOX			<p>The Display firmware is independent of the HeatNet control's firmware. A separate Display firmware file is required in order to update the display. This needs to be placed on the USB drive and plugged into the front panel of the boiler.</p> <p>This file will include any upgraded manuals, drawing, and revision sheets.</p> <p>Begin by selecting the file from the USB disk and following the on screen instructions.</p>
---------------------------	--	--	--





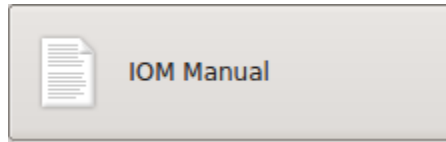
			<p>Enters the Load Firmware menu. Loading new firmware allows for upgrades and bug fixes to the HeatNet control. See the SOURCE section below or USB FEATURES section for help in loading new firmware. Check the <a href="http://www.rbiwaterheaters.com">http://www.rbiwaterheaters.com</a> website periodically for firmware updates.</p>
USB DRIVE		<p>USB DRIVE, SAVE FILE</p>	<p>Selecting the <b>USB DRIVE</b> tab will read the FIRMWARE directory on a flash drive and display any .hex files located in the FIRMWARE directory. Follow the on screen prompts and then select a file using the arrow keys. Once a file has been selected, a STORAGE LOCATION needs to be selected. There are (2) storage locations for the new file. Location 1 is used for normal updates and Location 0 is for the factory stored backup file. When the Storage location (default is Location 1) is selected the file will be loaded into a permanent storage memory location. Next, the control will reboot and copy this new program into running memory, reboot, load factory defaults, and then reboot again.</p> <p><b>NOTE: A directory named “firmware” must be on the drive, and all .hex files stored there.</b></p> <p>Selecting the <b>SAVE FILE</b> tab will display the currently stored files in the storage memory locations. Use the arrow keys to select a stored file for copying to running memory. When <b>SELECT</b> is pressed the file will be marked so it will be loaded on the next power cycle. Power cycle the boiler to begin copying the file from stored memory to running memory.</p> <p><b>NOTE:</b> to access the factory backup program, the P3 BOOT shunt on the control needs to be connected and the CAL/NORMAL switch placed in the CAL position. If the control is power cycled in this condition, the factory program will overwrite the existing running program. If in the LOAD FIRMWARE menus, STORAGE LOCATION 0 will be an allowed storage location.</p>



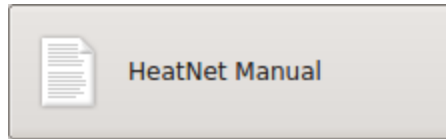
			<p>HeatNet Online is an Internet (over Ethernet) connection between a HeatNet control and the Mestek HeatNet Online Web Server. Using this connection, the control board will periodically send messages containing all data to capture the current operational state of the boiler. If the boiler is a master, data from all its member boilers will also be sent.</p> <p>The HeatNet Online server stores this information in a database. Users can log in to the HeatNet Online Web Site (<a href="http://www.heatnet.net/heatnet-online.aspx">www.heatnet.net/heatnet-online.aspx</a>) to view both present and historic data. The server also monitors the data in real time and will send out email alerts for faults, warnings, and other conditions that may require attention.</p> <p>For setup information, please refer to the <b>LCD Touchscreen HeatNet Online Setup Instruction Manual</b>.</p>
--	--	--	---

---

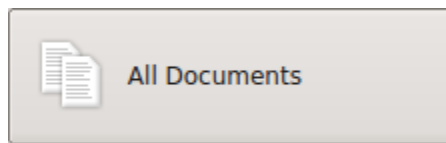
## Control Settings Menu — Page 4



The IOM Manual button when pressed, loads the Display firmware release PDF of the Boiler's IOM.



The HeatNet Manual button when pressed, loads the Display firmware release PDF of this manual.



The All Documents button when pressed, displays all the files available for reading, including the wiring diagrams of the boiler for the Display firmware release.

**Note: Updating the Display firmware will update these PDF documents to the current release.**

# MODBUS Communications

The FlexCore CK -Series control can be controlled using Modbus commands to Enable/Disable the boiler/system. A connection to the Console Modbus Port on the Communications board is required. The Master Boiler assumes the role of MEMBER, RTU, 192Kb, 8 bits, Even Parity, 1 stop bit, when connected to a BMS (Building Management System).

The Member Boilers should not be connected to a BMS system other than to view Read Only addresses. Refer to <http://www.rbiwaterheaters.com/> website for greater detail on communicating with Modbus, BACnet, or LonWorks protocols.

- Boiler01 = The Modbus connected boiler (Master or Standalone)
- Boiler02 = Member 2
- Boiler03 = Member 3
- ...
- Boiler16 = Member 16

**\*All Setpoint temperatures must be set in Fahrenheit**

Figure 60 MODBUS Input/Output Variables (Read/Write)					
Address	Name	Raw Data Type	Scale	Description	Valid Values/Range
40001	HeatDemand	1 bit unsigned	---	Heat Demand/Request. Setting the state member of this variable will put the boiler in heating mode.	0 = no heat demand 1 = heat demand
40002	SetpointTimer	16 bit unsigned	---	System Setpoint Timer  The system setpoint timer and system setpoint work in tandem to externally control (i.e. a BMS - building management system) the operating setpoint. The setpoint (countdown) timer should be loaded with a timeout value (in seconds) prior to writing the system setpoint. When the timer reaches zero, the control assumes that the BMS is no longer operating and the local setpoint (saved on the control) is reloaded. This is a failsafe feature used to help safeguard the system in case of BMS failure. If the setpoint timer is not written, a default timeout value of 60 seconds is assumed.	0 – 65535 seconds
40003	Setpoint	8 bit unsigned	1.0	System Setpoint (see <i>SetpointTimer</i> )	40 - 220 °F
40004	OARResetEnable	1 bit unsigned	---	Enables/Disables outdoor air reset mode.	0 = disabled 1 = enabled
40005	OARSetpoint	8 bit unsigned	1.0	Outdoor air reset setpoint. Temperature at which boiler shuts down.	40 – 100 °F
40006	OARHighWaterTemp	8 bit unsigned	1.0	Boiler water temperature setpoint when outdoor air temperature is at the high outdoor air temperature setpoint (OARHiAirTemp).	60 – 190 °F
40007	OARHighAirTemp	8 bit unsigned	1.0	High outdoor air temperature setpoint.	50 – 90 °F
40008	OARLowWaterTemp	8 bit unsigned	1.0	Header/Supply temperature setpoint when outdoor air temperature is at the low outdoor air temperature setpoint (OARLoAirTemp).	70 – 220 °F
40009	OARLowAirTemp	8 bit signed	1.0	Low outdoor air temperature setpoint.	-35 – 40 °F

Figure 60 MODBUS Input/Output Variables (Read/Write)					
Address	Name	Raw Data Type	Scale	Description	Valid Values/Range
40010	SetMonth	8 bit unsigned	---	Set real time clock – month ( <i>see SetClock</i> )	0 (January) - 11 (December)
40011	SetDay	8 bit unsigned	---	Set real time clock – day ( <i>see SetClock</i> )	1 – 31
40012	SetYear	8 bit unsigned	---	Set real time clock – year ( <i>see SetClock</i> )	0 – 99
40013	SetHour	8 bit unsigned	---	Set real time clock – hour ( <i>see SetClock</i> )	0 – 23
40014	SetMinute	8 bit unsigned	---	Set real time clock – minute ( <i>see SetClock</i> )	0 – 59
40015	SetSecond	8 bit unsigned	---	Set real time clock – second ( <i>see SetClock</i> )	0 – 59
40016	SetWeekday	8 bit unsigned	---	Set real time clock – weekday ( <i>see SetClock</i> )	1 (Monday) - 7 (Sunday)
40017	SetClock	1 bit unsigned	---	Set (write) the real time clock. Do Not Write more than once per minute To write the real time clock, the system variables (SetMonth, SetDay, SetYear, SetHour, SetMinute, SetSecond, SetWeekday) must first be loaded with the correct date and time. Then, a 1 must be written to the state portion of this system variable to write the new date and time to the system clock.	0 = no action 1 = set/write the clock
40018	DHWSetpoint	16 bit signed	1.0	DHW Setpoint	40 - 200 °F
40019	BMSGPMRate	16 bit unsigned	1.0	GPM rate to be loaded by BMS for calculating how many boilers can run based on flow.	0-1500 GPM
40020	BMSLimitBoilers	16 bit unsigned	1.0	Write the # of boilers that the BMS allows to fire. If x boilers are available, x becomes less than or equal to LimitBoilers.	0-16

Figure 61 MODBUS Input Variables (Read Only)					
Address	Name	Raw Data Type	Scale	Description	Valid Values/Range
30001	BoilersOn	8 bit unsigned	---	The number of boilers currently running.	0 – 16
30002	Modulation	8 bit unsigned	0.01	Current system modulation level.	0 – 100 %
30003	HeaderTemp	16 bit signed	0.01	Header / System temperature.	32 – 250 °F
30004	SupplyTemp	16 bit signed	0.01	Supply temperature.	32 – 250 °F
30005	ReturnTemp	16 bit signed	0.01	Return temperature.	32 – 250 °F
30006	OutsideTemp	16 bit signed	0.01	Outside air temperature.	-40 – 250 °F
30007	DHWTemp	16 bit signed	0.01	Domestic Hot Water temperature	32 – 250 °F
30008	StackTemp	16 bit signed	0.01	Stack temperature	0 – 500 °F
30009	Month	8 bit unsigned	---	Real time clock month.	0 (January) - 11 (December)

**Figure 61 MODBUS Input Variables (Read Only)**

Address	Name	Raw Data Type	Scale	Description	Valid Values/Range
30010	Day	8 bit unsigned	---	Real time clock day.	1 – 31
30011	Year	8 bit unsigned	---	Real time clock year.	0 – 99
30012	Hour	8 bit unsigned	---	Real time clock hour.	0 – 23
30013	Minute	8 bit unsigned	---	Real time clock minute.	0 – 59
30014	Second	8 bit unsigned	---	Real time clock second.	0 – 59
30015	Weekday	8 bit unsigned	---	Real time clock weekday.	1 (Monday) – 7 (Sunday)
30016	Boiler01Status1	16 bit unsigned	---	Boiler (1 – 16) status flags. These bits indicate the state of the 24VAC interlocks, ignition circuit, and various other conditions. See the values column for a list of conditions.  Boiler01 = Master Boiler02 = Member01 ... Boiler16 = Member15	See the “BoilerStatus1” and “BoilerStatus2” Tables below.
30017	Boiler01Status2				
30018	Boiler02Status1				
30019	Boiler02Status2				
30020	Boiler03Status1				
30021	Boiler03Status2				
30022	Boiler04Status1				
30023	Boiler04Status2				
30024	Boiler05Status1				
30025	Boiler05Status2				
30026	Boiler06Status1				
30027	Boiler06Status2				
30028	Boiler07Status1				
30029	Boiler07Status2				
30030	Boiler08Status1				
30031	Boiler08Status2				
30032	Boiler09Status1				
30033	Boiler09Status2				
30034	Boiler10Status1				
30035	Boiler10Status2				
30036	Boiler11Status1				
30037	Boiler11Status2				
30038	Boiler12Status1				
30039	Boiler12Status2				
30040	Boiler13Status1				
30041	Boiler13Status2				
30042	Boiler14Status1				
30043	Boiler14Status2				
30044	Boiler15Status1				
30045	Boiler15Status2				
30046	Boiler16Status1				
30047	Boiler16Status2				
30048	Boiler01RuntimeHigh16	16 bit unsigned	---		0 – 4294967295 seconds

Figure 61 MODBUS Input Variables (Read Only)					
Address	Name	Raw Data Type	Scale	Description	Valid Values/Range
30049	Boiler01RuntimeLow16			Boiler (1 – 16) Runtime seconds High (Upper) and Low (Lower) 16 bit counters. To get the actual runtime for any given boiler (##), the high and low 16 bit counters must be combined (concatenated) into a single 32 bit counter as:  Boiler##RuntimeHigh16:Boiler##RuntimeLow16  Example Boiler01Runtime = (Boiler01RuntimeHigh16 * 65536) + Boiler01RuntimeLow16  Boiler01 = Master Boiler02 = Member01 ... Boiler16 = Member15	
30050	Boiler02RuntimeHigh16				
30051	Boiler02RuntimeLow16				
30052	Boiler03RuntimeHigh16				
30053	Boiler03RuntimeLow16				
30054	Boiler04RuntimeHigh16				
30055	Boiler04RuntimeLow16				
30056	Boiler05RuntimeHigh16				
30057	Boiler05RuntimeLow16				
30058	Boiler06RuntimeHigh16				
30059	Boiler06RuntimeLow16				
30060	Boiler07RuntimeHigh16				
30061	Boiler07RuntimeLow16				
30062	Boiler08RuntimeHigh16				
30063	Boiler08RuntimeLow16				
30064	Boiler09RuntimeHigh16				
30065	Boiler09RuntimeLow16				
30066	Boiler10RuntimeHigh16				
30067	Boiler10RuntimeLow16				
30068	Boiler11RuntimeHigh16				
30069	Boiler11RuntimeLow16				
30070	Boiler12RuntimeHigh16				
30071	Boiler12RuntimeLow16				
30072	Boiler13RuntimeHigh16				
30073	Boiler13RuntimeLow16				
30074	Boiler14RuntimeHigh16				
30075	Boiler14RuntimeLow16				
30076	Boiler15RuntimeHigh16				
30077	Boiler15RuntimeLow16				
30078	Boiler16RuntimeHigh16				
30079	Boiler16RuntimeLow16				
30080	Boiler01Status3	16 bit unsigned	---	Boiler (1 – 16) stage control input flags. These bits indicate the state of the stage control inputs. See the values column for a list of conditions.	See the "BoilerStatus3" Table below.
30081	Boiler02Status3				
30082	Boiler03Status3				
30083	Boiler04Status3				
30084	Boiler05Status3				
30085	Boiler06Status3				
30086	Boiler07Status3				
30087	Boiler08Status3				

**Figure 61 MODBUS Input Variables (Read Only)**

Address	Name	Raw Data Type	Scale	Description	Valid Values/Range
30088	Boiler09Status3				
30089	Boiler10Status3				
30090	Boiler11Status3				
30091	Boiler12Status3				
30092	Boiler13Status3				
30093	Boiler14Status3				
30094	Boiler15Status3				
30095	Boiler16Status3				
----- The following registers are available starting in firmware version 2.0 -----					
30096	Boiler01SupplyTemp	16 bit signed	0.01	Boiler (1 – 16) supply temperature (if available). See BoilerStatus2 to determine if the sensor is present.  Boiler01 = Master Boiler02 = Member01 ... Boiler16 = Member15	32 – 250 °F
30097	Boiler02SupplyTemp				
30098	Boiler03SupplyTemp				
30099	Boiler04SupplyTemp				
30100	Boiler05SupplyTemp				
30101	Boiler06SupplyTemp				
30102	Boiler07SupplyTemp				
30103	Boiler08SupplyTemp				
30104	Boiler09SupplyTemp				
30105	Boiler10SupplyTemp				
30106	Boiler11SupplyTemp				
30107	Boiler12SupplyTemp				
30108	Boiler13SupplyTemp				
30109	Boiler14SupplyTemp				
30110	Boiler15SupplyTemp				
30111	Boiler16SupplyTemp				
30112	Boiler01ReturnTemp	16 bit signed	0.01	Boiler (1 – 16) return temperature (if available). See BoilerStatus2 to determine if the sensor is present.  Boiler01 = Master Boiler02 = Member01 ... Boiler16 = Member15	32 – 250 °F
30113	Boiler02ReturnTemp				
30114	Boiler03ReturnTemp				
30115	Boiler04ReturnTemp				
30116	Boiler05ReturnTemp				
30117	Boiler06ReturnTemp				
30118	Boiler07ReturnTemp				
30119	Boiler08ReturnTemp				
30120	Boiler09ReturnTemp				
30121	Boiler10ReturnTemp				
30122	Boiler11ReturnTemp				
30123	Boiler12ReturnTemp				
30124	Boiler13ReturnTemp				
30125	Boiler14ReturnTemp				

Figure 61 MODBUS Input Variables (Read Only)					
Address	Name	Raw Data Type	Scale	Description	Valid Values/Range
30126	Boiler15ReturnTemp				
30127	Boiler16ReturnTemp				
30128	Boiler01CyclesHigh16	16 bit unsigned	---	Boiler (1 – 16) Cycles High (Upper) and Low (Lower) 16 bit counters. To get the actual cycle count for any given boiler (##), the high and low 16 bit counters must be combined (concatenated) into a single 32 bit counter as:  Boiler##CyclesHigh16:Boiler##CyclesLow16  Example Boiler01Cycles = (Boiler01CyclesHigh16 * 65536) + Boiler01CyclesLow16  Boiler01 = Master Boiler02 = Member01 ... Boiler16 = Member15	0 – 4294967295
30129	Boiler01CyclesLow16				
30130	Boiler02CyclesHigh16				
30131	Boiler02CyclesLow16				
30132	Boiler03CyclesHigh16				
30133	Boiler03CyclesLow16				
30134	Boiler04CyclesHigh16				
30135	Boiler04CyclesLow16				
30136	Boiler05CyclesHigh16				
30137	Boiler05CyclesLow16				
30138	Boiler06CyclesHigh16				
30139	Boiler06CyclesLow16				
30140	Boiler07CyclesHigh16				
30141	Boiler07CyclesLow16				
30142	Boiler08CyclesHigh16				
30143	Boiler08CyclesLow16				
30144	Boiler09CyclesHigh16				
30145	Boiler09CyclesLow16				
30146	Boiler10CyclesHigh16				
30147	Boiler10CyclesLow16				
30148	Boiler11CyclesHigh16				
30149	Boiler11CyclesLow16				
30150	Boiler12CyclesHigh16				
30151	Boiler12CyclesLow16				
30152	Boiler13CyclesHigh16				
30153	Boiler13CyclesLow16				
30154	Boiler14CyclesHigh16				
30155	Boiler14CyclesLow16				
30156	Boiler15CyclesHigh16				
30157	Boiler15CyclesLow16				
30158	Boiler16CyclesHigh16				
30159	Boiler16CyclesLow16				
30160	Boiler01Status4	16 bit unsigned	---	Boiler (1 – 16) status4 flags. These bits indicate the state of various boiler statuses. Boiler01 = Master or “Connected Boiler” Boiler02 = Member01 ... Boiler16 = Member15	See the BoilerStatus4 Flags in Appendix A.
30161	Boiler02Status4				
30162	Boiler03Status4				
30163	Boiler04Status4				
30164	Boiler05Status4				



Figure 61 MODBUS Input Variables (Read Only)

Address	Name	Raw Data Type	Scale	Description	Valid Values/Range
30165	Boiler06Status4				
30166	Boiler07Status4				
30167	Boiler08Status4				
30168	Boiler09Status4				
30169	Boiler10Status4				
30170	Boiler11Status4				
30171	Boiler12Status4				
30172	Boiler13Status4				
30173	Boiler14Status4				
30174	Boiler15Status4				
30175	Boiler16Status4				
30176 ... 30207	RESERVED	---	---	---	---
30208	Boiler01DHWTemp	16 bit signed	---	Boiler (1 – 16) DHW temperature (if available). See BoilerStatus4 to	32 – 250 °F
30209	Boiler02DHWTemp				
30210	Boiler03DHWTemp				
30211	Boiler04DHWTemp				
30212	Boiler05DHWTemp				
30213	Boiler06DHWTemp				
30214	Boiler07DHWTemp				
30215	Boiler08DHWTemp				
30216	Boiler09DHWTemp				
30217	Boiler10DHWTemp				
30218	Boiler11DHWTemp				
30219	Boiler12DHWTemp				
30220	Boiler13DHWTemp				
30221	Boiler14DHWTemp				
30222	Boiler15DHWTemp				
30223	Boiler16DHWTemp				
30224	Boiler01Modulation	16 bit signed	---	The running (“display”) modulation. This is typically the actual running modulation except under special circumstances when the boiler is running in a self-protection mode (Op. Limit, ½ Fire Rate, etc.) Boiler01 = Master or “Connected Boiler” Boiler02 = Member01 ... Boiler16 = Member15	0 - 100
30225	Boiler02Modulation				
30226	Boiler03Modulation				
30227	Boiler04Modulation				
30228	Boiler05Modulation				
30229	Boiler06Modulation				
30230	Boiler07Modulation				
30231	Boiler08Modulation				
30232	Boiler09Modulation				

<b>Figure 61 MODBUS Input Variables (Read Only)</b>					
<b>Address</b>	<b>Name</b>	<b>Raw Data Type</b>	<b>Scale</b>	<b>Description</b>	<b>Valid Values/Range</b>
30233	Boiler10Modulation				
30234	Boiler11Modulation				
30235	Boiler12Modulation				
30236	Boiler13Modulation				
30237	Boiler14Modulation				
30238	Boiler15Modulation				
30239	Boiler16Modulation				
30240	OperatingSetpoint	16 bit signed	---	This is the current operating or active setpoint. It may be: 1) The normal heating setpoint. 2) The DHW setpoint if running in DHW mode. 3) A calculated setpoint if running in Outdoor Air Reset Mode 4) The 4-20 mA (0-10V) setpoint.	40 - 220 °F
30241	AvailableBoilers	16 bit signed	---	The maximum number of boilers available to fire.	0 - 16
30242	BTUHigh16	32 bit unsigned			
30243	BTULow16				
30247	SystemReturnTemp	16 bit signed	---	The system return temperature (if available). See BoilerStatus4 to determine if the sensor is present.	32 – 250 °F
30265	SystemFlowHigh16	32 bit unsigned	0.01	Boiler SystemFlow High (Upper) and Low (Lower) 16 bit registers. To get Boiler SystemFlow High (Upper) and Low (Lower) 16 bit registers. To get the actual SystemFlow, the high and low 16 bit registers must be combined (concatenated) into a single 32 bit counter as:  SystemFlowHigh16: SystemFlowLow16  Example $SystemFlow = ((SystemFlowHigh16 * 65536) + SystemFlowLow16) * 0.01$  This value is either the system flow meter reading or the value written to the BMSFlowRateGPM register by the BMS.	0-1500 GPM
30266	SystemFlowLow16				
30269	HeatingBoilersOn	8 bit unsigned	---	The number of boilers currently running for heating.	0 – 16
30270	DHWBoilersOn	8 bit unsigned	---	The number of boilers currently running for DHW.	0 – 16
30271	ManualBoilersOn	8 bit unsigned	---	The number of boilers currently running due to a local override, T1, T2, AA/High Fire, etc.	0 – 16

<b>Figure 62 MODBUS — BoilerStatus1 Flags</b>		
<b>Bit</b>	<b>Description</b>	<b>Valid Values/Range</b>
0	Pilot Valve	0 = closed, 1 = open
1	Blower Running	0 = off, 1 = running
2	Ignition Alarm	0 = ok, 1 = alarm
3	Valve Alarm	0 = ok, 1 = alarm
4	High Limit	0 = ok, 1 = tripped
5	Air Prove Switch	1 = open, 0 = closed
6	RESERVED (FACTORY)	
7	Software Operator	0 = off, 1 = on
8	Header Sensor not Detected	0 = detected, 1 = not detected
9	Supply Sensor not Detected	0 = detected, 1 = not detected
10	Return Sensor not Detected	0 = detected, 1 = not detected
11	Outside Sensor not Detected	0 = detected, 1 = not detected
12	System Pump	0 = off, 1 = on
13	Combustion Air Damper Obsolete –Available only on v1.x controls	0 = off, 1 = on
14	Master Boiler	0 = member, 1 = Master
15	Boiler Detected (at this address)	0 = not detected, 1 = detected

<b>Figure 63 MODBUS — BoilerStatus2 Flags</b>		
<b>Bit</b>	<b>Description</b>	<b>Valid Values/Range</b>
0	Disabled – boiler is offline For instance: Minimum off Time, Flow, Local Override, Calibrate etc.	0 = enabled, 1 = disabled
1	Heat Demand	0 = no demand, 1 = demand (1)
2	Alarm An alarm or warning condition has occurred. An attempt(s) will automatically be made to recover and resume normal operation.	0 = ok, 1 = alarm
3	Failed A condition has occurred under which the boiler can no longer run.	0 = ok, 1 = failed
4	Member Error An “Alarm” or “Failed” condition has occurred on one (or more) of the member boilers.	0 = ok, 1 = error
5	Boiler Running Main Valve is open and Modulation Delay time has expired	0 = off, 1 = running
6	Pump Running	0 = off, 1 = running
7	Spare 3 Interlock	0 = open, 1 = closed
8	LWCO Interlock (Low Water Cut Off)	0 = open, 1 = closed
9	VFD Interlock (Variable Frequency Drive)	0 = open, 1 = closed

<b>Figure 63 MODBUS — BoilerStatus2 Flags</b>		
<b>Bit</b>	<b>Description</b>	<b>Valid Values/Range</b>
10	Gas Prove Interlock	0 = open, 1 = closed
11	Spare 4 Interlock	0 = open, 1 = closed
12	Operator Interlock	0 = open, 1 = closed
13	Water Prove (Flow) Interlock	0 = open, 1 = closed
14	UV Sensor Air Prove Interlock	0 = open, 1 = closed
15	Main Valve	0 = closed, 1 = open

This BoilerStatus2 Heat Demand Flag is a combination of the Heat Demand input and the Modbus Heat Demand (40001).

<b>Figure 64 MODBUS — BoilerStatus3 Flags</b>		
<b>Bit</b>	<b>Bit</b>	<b>Bit</b>
0	AA High Fire	0 = off, 1 = on
1	Heat Demand (Local Override)	0 = off, 1 = on (1)
2	4-20 mA Remote Enable	0 = off, 1 = on
3	Outdoor Air Reset Override	0 = off, 1 = on
4	T1	0 = off, 1 = on
5	T2	0 = off, 1 = on
6	Obsolete	0 = off, 1 = on
7	Obsolete	0 = off, 1 = on
8	reserved for future use	---
9	reserved for future use	---
10	reserved for future use	---
11	reserved for future use	---
12	reserved for future use	---
13	reserved for future use	---
14	reserved for future use	---
15	reserved for future use	---

This BoilerStatus3 Heat Demand Flag is Heat Demand input. On member boilers, this indicates a “Local Override”.

## BoilerStatus4 Flags

Bit	Description	Valid Values/Range
0	DHW Enabled (1) DHW Mode had been enabled in the menus.	0 = off, 1 = on (menu)
1	Combustion Air Damper Prove (1) Status of Combustion Air Damper Prove Input J12B	0 = not proven, 1 = proven
2	Call Service Fault	0 = off, 1 = on
3	Air Switch (Blower) Fault	0 = off, 1 = on
4	---	---
5	---	---
6	---	---
7	---	---
8	---	---
9	DHW Sensor not detected (1)	0 = detected, 1 = not detected
10	DHW Boiler (1) This control board has been designated a DHW boiler by cutting the DHW jumper (JPS1).	0 = no, 1 = yes (DHW jumper cut)
11	Operating Limit Clamp (1) Boiler input is being limited (clamped) due to a high supply (outlet) temperature.	0 = off, 1 = clamped
12	Firing boilers limited by value in BMS Flow Rate Register (1)	0 = not limited, 1 = limited
13	Firing boilers limited by value in BMS Limit Boilers Register (1)	0 = not limited, 1 = limited
14	Stack Sensor not detected (2)	0 = detected, 1 = not detected
15	System Return Sensor not detected (2)	0 = detected, 1 = not detected

(1) Available in firmware version 1.30+.

(2) Available in firmware version 2.00+.

# Worksheet

<b>SETUP MENU</b>				
<b>BOILERS</b>				
# of BOILERS				
LEAD STAGE				
HEAT BAND		°		
<b>SETPOINTS</b>				
SYSTEM/LOCAL SETPOINT		°		
OPERATE LIMIT		°		
OP LIM BAND		°		
SETPOINT SOURCE				
<b>OUTDOOR AIR RESET</b>		°		
OA RESET				
WARM WEATHER SD				
WWS SETPOINT		°		
SET OA SETPOINTS				
WATER TEMP		°		
@				
HIGH OA TEMP		°		
WATER TEMP		°		
@				
LOW OA TEMP		°		
<b>PUMP OPTIONS</b>				
SYSTEM PUMP				
POST PURGE TIME				
PUMP ROTATION				
ROTATION:				
SYSTEM PUMPS:				
ROTATE TIME:				
MORE MENUS				
ZERO RUNTIME PUMP				
PUMP1 TIME				
PUMP2 TIME				
ALWAYS ENABLED				
SUMMER PUMP JOG				
OVR ENAB IN WWS				
<b>LOCAL PUMP</b>				
DELTA TEMP ENAB				
DELTA TEMP		°		
POST PRGE TIME		s		
ALWAYS ENABLED				

PUMP/VALVE OPTION				
REMAINS ON:				
LOCAL PUMP VFD				
FLOW PROVE				
NIGHT SETBACK				
SETBACK ENTRY	1	2	3	4
ENTRY IS				
SETBACK	°	°	°	°
SETBACK TIME				
START DAY				
TIME				
END DAY				
TIME				
OPTIONS				
TEMP SCALE	°			
KEY CLICK				
SKIP PASSWORD				
BRIGHTNESS	%			
LOG/ RUNTIME				
RUN HOURS				
DATA LOG ENTRY				
SIZE				
BOILER CYCLES				
AUX FUNCTIONS				
COMBUST AIR DAMPER				
TYPE:				
IN USE?				
INPUT:				
PROOF TIME				
ALARM SILENCE SWITCH				
IN USE				
INPUT:				
FAILSAFE MODES				
H-NET COMM LOST				
LOW TEMP:				
TEMP <				
HEAT EXCHANGER				
EXCHGR DELTA T				
LIMIT-> HALF RATE				
SEND RETURN				
TEMPERATURE DISABLE				
TEMP <				
EXTENDED PP TIME				

MAXIMUM RUNTIME				
DOMESTIC HOT WATER				
DHW BOILER?				
DHW SETPOINT				
LOWER DHW DIFF				
UPPER DHW DIFF				
DHW PRIORITY?				
POST PURGE				
USE SENSOR?				
SHARING				
LOCAL PUMP OFF				
LOCAL DELAY				
PURGE TO THE				
HYB SENSOR:				
MAX RUNTIME				
HOLDOFF TIME				
PUMP ALWAYS ON				
SYSTEM CLOCK				

<b>ADVANCED SETUP</b>				
DISTRIBUTED CTRL				
HeatNet Master				
MASTER TYPE				
H-NET ADDRESS				
MODULAR BOILER SET				
SPACE HEATING				
ADD BOILER DELAY				
SHED BOILER DELAY				
MODULATE DELAY TIME				
MOD MAX – LAST FIRE		%		
DHW HEATING				
ADD BOILER DELAY				
SHED BOILER DELAY				
MODULATE DELAY TIME				
MOD MAX – LAST FIRE		%		
RELEASE MODULATION MAX				
ADAPTIVE MOD				
MOD MODE:				
DROP DOWN				
DELAY RELEASE				
FIRING MODE				
MODE				
MIXED START PRIORITY 1				



SET:								
STOP PRIORITY 1								
SET:								
MIN RUNTIME								
MIN OFF TIME								
FIRING PRIORITY								
PREDICT START								
BASE LOADING								
BASE LOAD BOILERS:								
START > MOD								
STOP								
DELAY TIME								
SENSORS								
SENSOR #	OUTSIDE	SUPPLY	R E T U R N	H E A D E R	DHW	6	7	8
TYPE								
4-20 mA INPUT								
ANALOG IN CHANNEL:								
CHANNEL MODE:								
4 mA SETPOINT								
20 mA SETPOINT								
BOILER START								
PRIORITY								
PASSWORD								
COMMUNICATIONS								
Modbus Address								
BAUD								
DATA FORMAT								
SETPOINT TIMER								
SETPOINT TIME								
FLOWMETER								
FLOWMETER								
GLYCOL MIX								
INPUT TYPE								
LOWEST FLOW								
HIGHEST FLOW								
FULL SCALE								
FLOW FACTOR								
BLOWER SETTINGS (AMETEK BLOWER)								
ACCELERATE								
DECELERATE								
SOFT START SECS:								
OFF BOILER-BLOWR%								

SYSTEM				
CONFIGURE INTERLKS				
INTRLK ASSIGNMENTS				
SYSTEM FLOW... ON				
LOAD FIRMWARE	Version:			
OPTION:				
BOILER TYPE				
PRODUCT				
CONDENSING				
BTU IN				
MORE MENUS				
BLOWER				
MASS				
TURNDOWN				
ALTITUDE				

CALIBRATION SETTINGS

MINIMUM (%)	
IGNITION (%)	
MAXIMUM (%)	

## Type II Thermistor Resistance/Temperature Table

Temp °C	Temp °F	Resistance	Temp °C	Temp °F	Resistance
-40	-40	336,450	60	140	2,488
-35	-31	242,660	65	149	2,083
-30	-22	176,960	70	158	1,752
-25	-13	130,410	75	167	1,479
-20	-4	97,072	80	176	1,255
-15	5	72,951	85	185	1,070
-10	14	55,326	90	194	915.4
-5	23	43,326	95	203	786.6
0	32	32,650	100	212	678.6
5	41	25,391	105	221	587.6
10	50	19,899	110	230	510.6
15	59	15,711	115	239	445.2
20	68	12,492	120	248	389.6
25	77	10,000	125	257	341.9
30	86	8,057	130	266	301.0
35	95	6,531	135	275	265.8
40	104	5,326	140	284	235.4
45	113	4,368	145	293	209.0
50	122	3,602	150	302	186.1
55	131	2,986			